

Flux - Media Unit

FL-MM3



ASSEMBLY INSTRUCTIONS

Flux
Media Unit

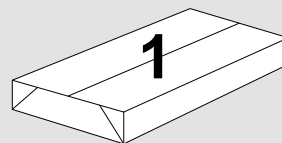

Pack 1:
1x Frame
FL_3X5_UO_3X2

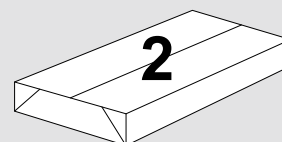

Pack 2:
1x Media Unit
FL-MU-3X2

TOOLS REQUIRED
FOR ASSEMBLY



DONT STRUGGLE
2 MAN LIFT

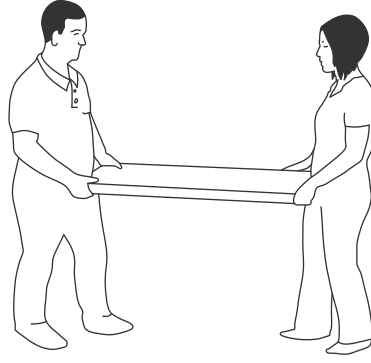
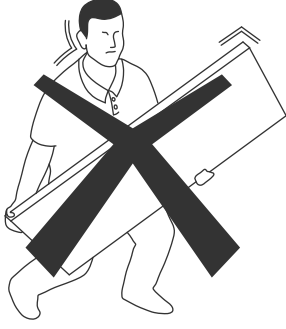

ALWAYS HANDLE
ITEMS WITH CARE

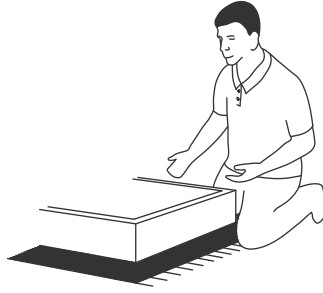
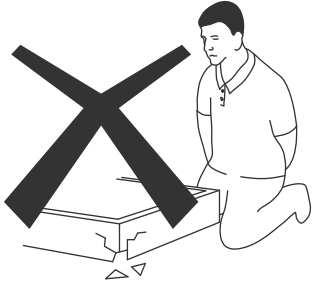

IF UNSURE CALL
FOR ASSISTANCE

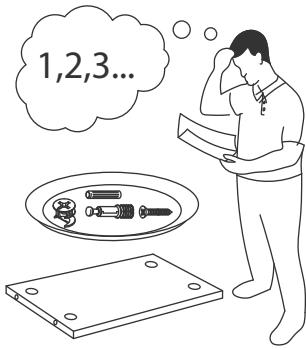

KEEP FITTINGS AWAY
FROM CHILDREN

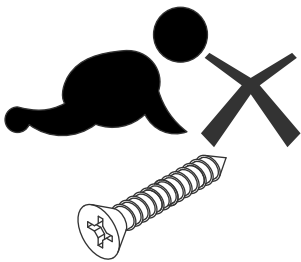



Please check that you have all the panels

FL-MU-3X2

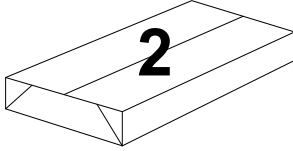

PACK 2:
1 x Media Unit

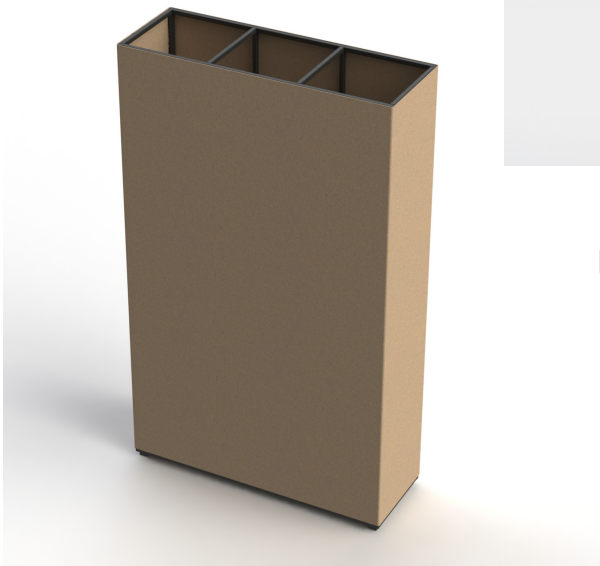
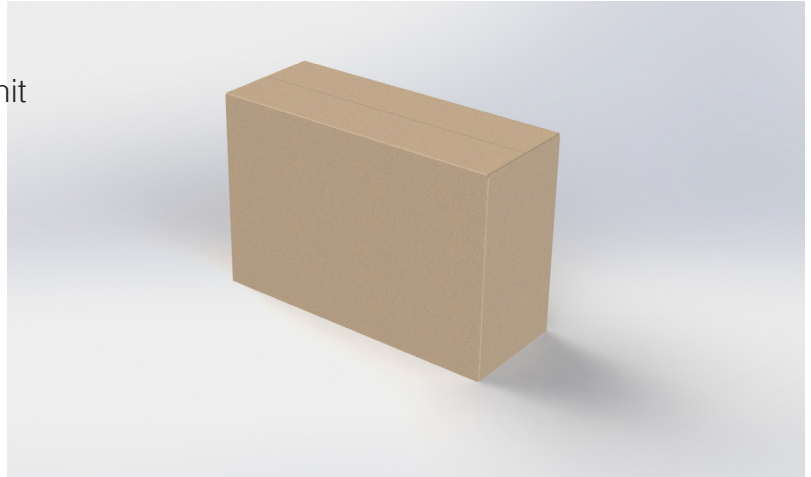

FL_3X5_UO_3X2

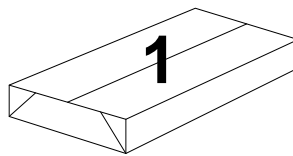

PACK 1:
1 x Frame



Please check that you have all the fittings

FITTINGS SUPPLIED



Screw-in Pin

Size
13mm

PCS
4

FLUX MEDIA UNIT ASSEMBLY

1

Step 1

Unpack your new media unit and frame and please recycle all packaging.

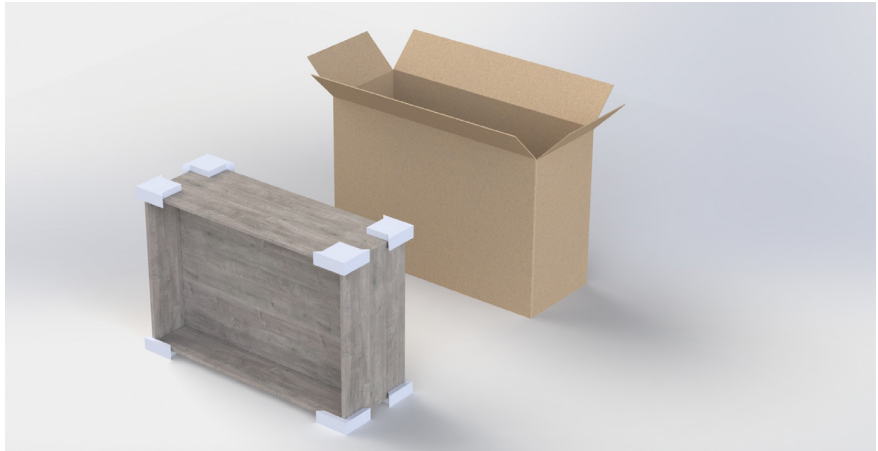

2

Step 2

Ensure the frame is vertical prior to placing the media unit into position.

Lift and insert the media unit into the opening of the frame (2x person(s) required) making sure it is flush with the frame front and back.

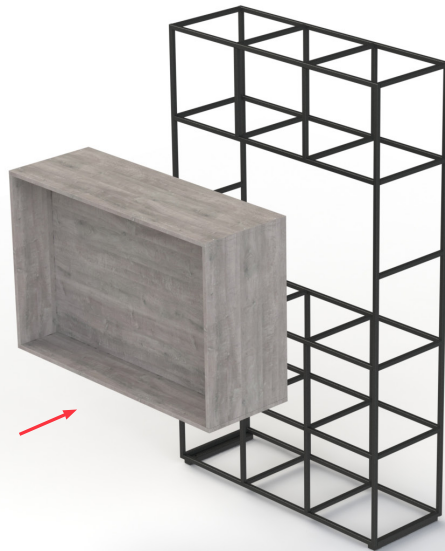

3

Step 3

Fix the media unit into location using the screw-in pins turning clockwise.

