

USER MANUAL



U32U3CV MONITOR

AOC.COM

©2024 AOC. All rights reserved
Version: A00

AOC

Safety.....	1
National Conventions.....	1
Power.....	2
Installation.....	3
Cleaning.....	4
Other.....	5
Setup.....	6
Contents in Box.....	6
Set-up Stand & Base.....	7
Adjusting Viewing Angle.....	8
Connecting the Monitor.....	9
Wall Mounting.....	10
Adaptive-Sync function.....	11
KVM.....	12
HDR.....	13
Calman ready.....	14
Adjusting.....	17
Hotkeys.....	17
OSD Setting.....	18
Preset Mode.....	19
Picture.....	20
Input.....	23
PIP/PBP.....	24
Settings.....	25
OSD Setup.....	26
Information.....	27
LED Indicator.....	28
Troubleshoot.....	29
Specification.....	30
General Specification.....	30
Preset Display Modes.....	31
Pin Assignments.....	32
Plug and Play.....	33

Safety

National Conventions

The following subsections describe national conventions used in this document.

Notes, Cautions, and Warnings

Throughout this guide, blocks of text may be accompanied by an icon and printed in bold type or in italic type. These blocks are notes, cautions, and warnings, and they are used as follows:



NOTE: A NOTE indicates important information that helps you make better use of your computer system.





CAUTION: A CAUTION indicates either potential damage to hardware or loss of data and tells you how to avoid the problem.



WARNING: A WARNING indicates the potential for bodily harm and tells you how to avoid the problem. Some warnings may appear in alternate formats and may be unaccompanied by an icon. In such cases, the specific presentation of the warning is mandated by regulatory authority.

Power

 The monitor should be operated only from the type of power source indicated on the label. If you are not sure of the type of power supplied to your home, consult your dealer or local power company.

 The monitor is equipped with a three-pronged grounded plug, a plug with a third (grounding) pin. This plug will fit only into a grounded power outlet as a safety feature. If your outlet does not accommodate the three-wire plug, have an electrician install the correct outlet, or use an adapter to ground the appliance safely. Do not defeat the safety purpose of the grounded plug.

 Unplug the unit during a lightning storm or when it will not be used for long periods of time. This will protect the monitor from damage due to power surges.

 Do not overload power strips and extension cords. Overloading can result in fire or electric shock.

 To ensure satisfactory operation, use the monitor only with UL listed computers which have appropriate configured receptacles marked between 100-240V AC, Min. 5A.

 The wall socket shall be installed near the equipment and shall be easily accessible.

Installation

! Do not place the monitor on an unstable cart, stand, tripod, bracket, or table. If the monitor falls, it can injure a person and cause serious damage to this product. Use only a cart, stand, tripod, bracket, or table recommended by the manufacturer or sold with this product. Follow the manufacturer's instructions when installing the product and use mounting accessories recommended by the manufacturer. A product and cart combination should be moved with care.

! Never push any object into the slot on the monitor cabinet. It could damage circuit parts causing a fire or electric shock. Never spill liquids on the monitor.

! Do not place the front of the product on the floor.

! If you mount the monitor on a wall or shelf, use a mounting kit approved by the manufacturer and follow the kit instructions.

! Leave some space around the monitor as shown below. Otherwise, air-circulation may be inadequate hence overheating may cause a fire or damage to the monitor.

! To avoid potential damage, for example the panel peeling from the bezel, ensure that the monitor does not tilt downward by more than -5 degrees. If the -5 degree downward tilt angle maximum is exceeded, the monitor damage will not be covered under warranty.

See below the recommended ventilation areas around the monitor when the monitor is installed on the wall or on the stand:

Installed with stand

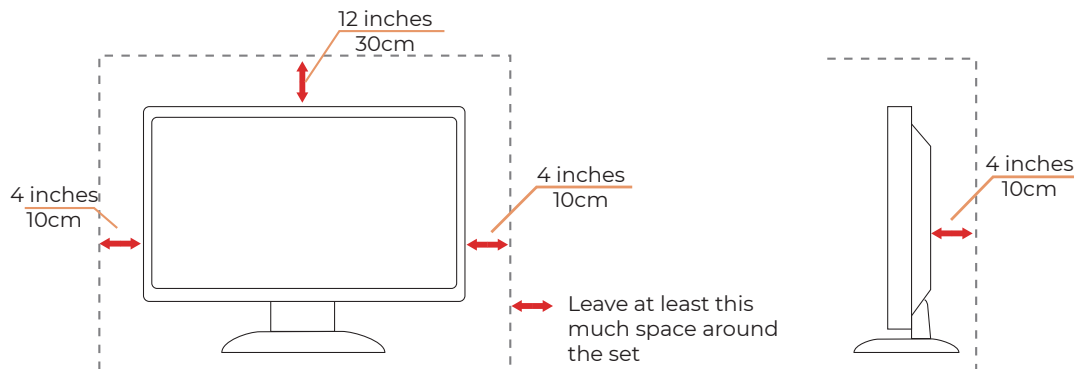

Cleaning

! Clean the cabinet regularly with a water-dampened, soft cloth.

! When cleaning use a soft cotton or microfiber cloth. The cloth should be damp and almost dry, do not allow liquid into the case.



! Please disconnect the power cord before cleaning the product.

Other

 If the product is emitting a strange smell, sound or smoke, disconnect the power plug IMMEDIATELY and contact a Service Center.

 Make sure that the ventilating openings are not blocked by a table or curtain.

 Do not engage the LCD monitor in severe vibration or high impact conditions during operation.

 Do not knock or drop the monitor during operation or transportation.

 The power cords shall be safety approved. For Germany, it shall be H03VV-F, 3G, 0.75 mm², or better. For other countries, the suitable types shall be used accordingly.

 Excessive sound pressure from earphones and headphones can cause hearing loss. Adjustment of the equalizer to maximum increases the earphones and headphones output voltage and therefore the sound pressure level.

Setup

Contents in Box



Monitor

*



Quick Start Guide

*



Warranty Card

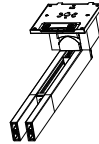

Stand



Base

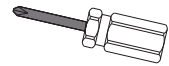

Screwdriver



Power Cable

*



HDMI Cable

*



DP Cable

*



USB C-C Cable

*



USB C-C/A Cable

* Not all signal cables will be provided for all countries and regions. Please check with the local dealer or AOC branch office for confirmation.

Set-up Stand & Base

Please setup or remove the base following the steps as below.

Setup:

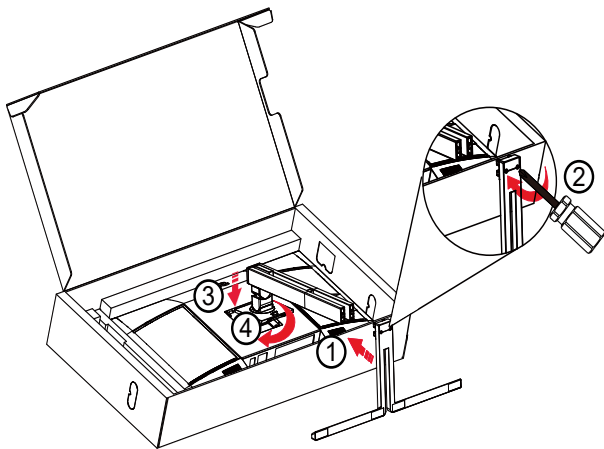

Note: Align the stand with the positioning holes in the base. Hold the stand and base without gaps and lock the two screws at the bottom before releasing the support to prevent it from falling.

Remove:

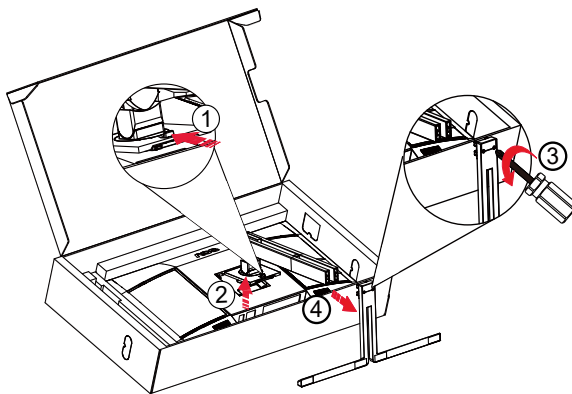

Specification for base screw:
M5*21 mm (effective thread 5.5 mm)

 **NOTE:** Display design may differ from those illustrated.

Adjusting Viewing Angle

To achieve the best viewing experience, it is recommended that the user can make sure they are able to look at their whole face on the screen, then adjust the monitor's angle based on personal preference.

Hold the stand so you will not topple the monitor when you change the monitor's angle.

You are able to adjust the monitor as below:

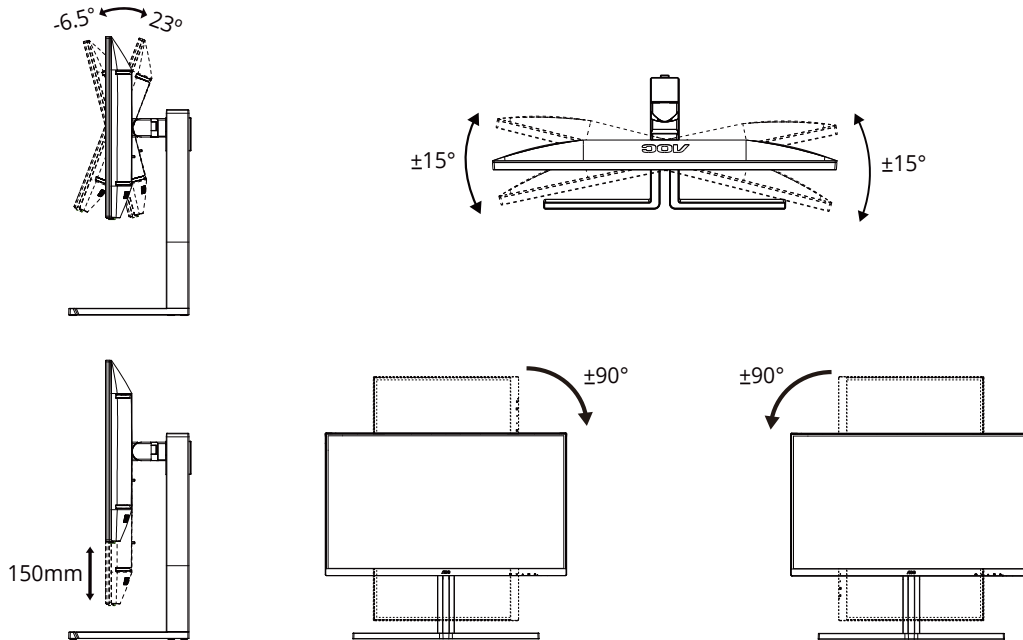

 **NOTE:**

Do not touch the LCD screen when you change the angle. Touching the LCD screen may cause damage.

 **Warning**

- To avoid potential screen damage, such as panel peeling, ensure that the monitor does not tilt downward by more than -5 degrees.
- Do not press the screen while adjusting the angle of the monitor. Grasp only the bezel.

Connecting the Monitor

Cable Connections In Back of Monitor and Computer:

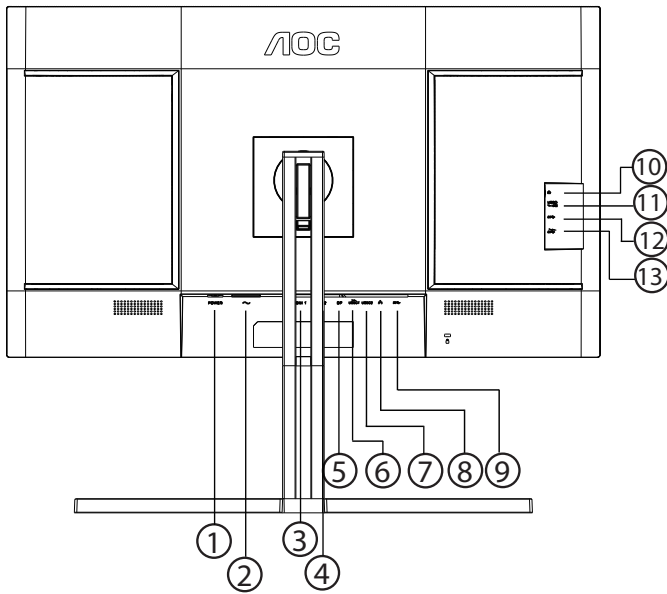

1. Power Switch
2. Power
3. HDMI 1
4. HDMI 2
5. DisplayPort
6. USB C1 (Video, PD 96W)
7. USB C2 (upstream, data only)
8. RJ45
9. USB3.2 Gen2 downstream
10. Earphone
11. USB C (Side): Power supply up to 15W
12. USB3.2 Gen2 downstream
13. USB3.2 Gen2 downstream+charging

Connect to PC

1. Connect the power cord to the back of the display firmly.
2. Turn off your computer and unplug its power cable.
3. Connect the display signal cable to the video connector on the back of your computer.
4. Plug the power cord of your computer and your display into a nearby outlet.
5. Turn on your computer and display.

If your monitor displays an image, installation is complete. If it does not display an image, please refer to Troubleshoot.

To protect equipment, always turn off the PC and LCD monitor before connecting.

Wall Mounting

Preparing to Install An Optional Wall Mounting Arm.

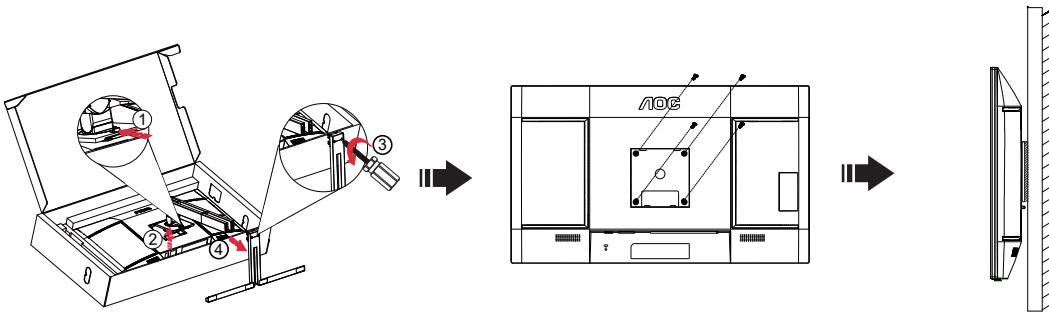

This monitor can be attached to a wall mounting arm you purchase separately. Disconnect power before this procedure. Follow these steps:

1. Remove the base.
2. Follow the manufacturer's instructions to assemble the wall mounting arm.
3. Place the wall mounting arm onto the back of the monitor. Line up the holes of the arm with the holes in the back of the monitor.
4. Insert the 4 screws into the holes and tighten.
5. Reconnect the cables. Refer to the user's manual that came with the optional wall mounting arm for instructions on attaching it to the wall.

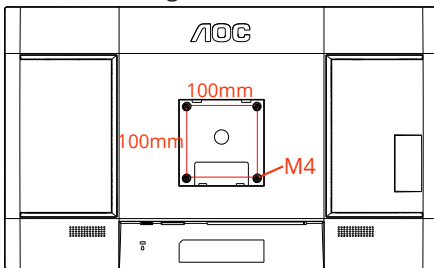

Specification of wall hanger screws: M4*(10+X)mm (X=Thickness of Wall mount bracket)

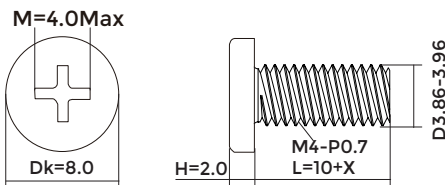

Note: VESA mounting screw holes are not available for all models, please check with the dealer or official department of AOC. Always contact manufacturer for wall-mount installation.

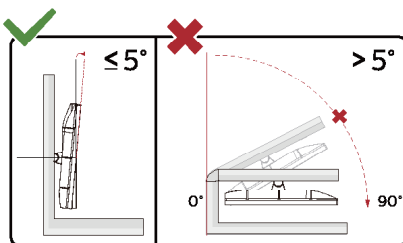

* Display design may differ from those illustrated.

⚠WARNING:

1. To avoid potential screen damage, such as panel peeling, ensure that the monitor does not tilt downward by more than -5 degrees.
2. Do not press the screen while adjusting the angle of the monitor. Grasp only the bezel.

Adaptive-Sync function

1. Adaptive-Sync function works with DisplayPort/HDMI/USB C
2. Compatible Graphics Card: Recommended list is as below, also could be checked by visiting www.AMD.com

Graphics Cards

- Radeon™ RX Vega series
- Radeon™ RX 500 series
- Radeon™ RX 400 series
- Radeon™ R9/R7 300 series (R9 370/X, R7 370/X, R7 265 except)
- Radeon™ Pro Duo (2016)
- Radeon™ R9 Nano series
- Radeon™ R9 Fury series
- Radeon™ R9/R7 200 series (R9 270/X, R9 280/X except)

Processors

- AMD Ryzen™ 7 2700U
- AMD Ryzen™ 5 2500U
- AMD Ryzen™ 5 2400G
- AMD Ryzen™ 3 2300U
- AMD Ryzen™ 3 2200G
- AMD PRO A12-9800
- AMD PRO A12-9800E
- AMD PRO A10-9700
- AMD PRO A10-9700E
- AMD PRO A8-9600
- AMD PRO A6-9500
- AMD PRO A6-9500E
- AMD PRO A12-8870
- AMD PRO A12-8870E
- AMD PRO A10-8770
- AMD PRO A10-8770E
- AMD PRO A10-8750B
- AMD PRO A8-8650B
- AMD PRO A6-8570
- AMD PRO A6-8570E
- AMD PRO A4-8350B
- AMD A10-7890K
- AMD A10-7870K
- AMD A10-7850K
- AMD A10-7800
- AMD A10-7700K
- AMD A8-7670K
- AMD A8-7650K
- AMD A8-7600
- AMD A6-7400K

KVM

This product supports the KVM feature.

In the display on state, you can control two signal output devices (two computers, or two laptops, or one computer and one laptop) with a keyboard and mouse set through the KVM feature.

Setup steps:

1. Use the USB C to USB C cable to connect the monitor to the first device (computer or laptop) through the USB C1 connector.
2. Connect the monitor to the second device (computer or laptop) through the HDMI or DisplayPort (input) connector, and connect the USB C2 of the monitor to the USB connector of the device using the USB C to USB A cable.
3. Connect the peripheral devices (keyboard and mouse) to the USB A (USB downstream) connector of the monitor.

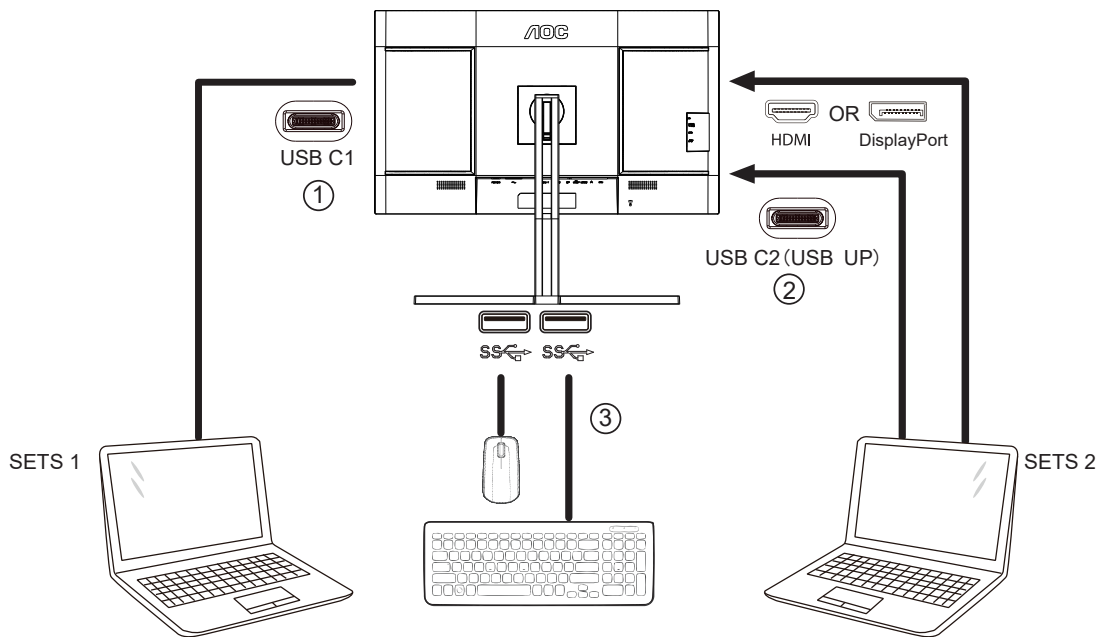

4. Go to the OSD menu. Set Auto, USB C1 or USB C2 in Settings -> USB Selection respectively when needed. If it is set to Auto, the keyboard and mouse connected to the monitor will automatically switch the controlled devices according to the displayed signal source.

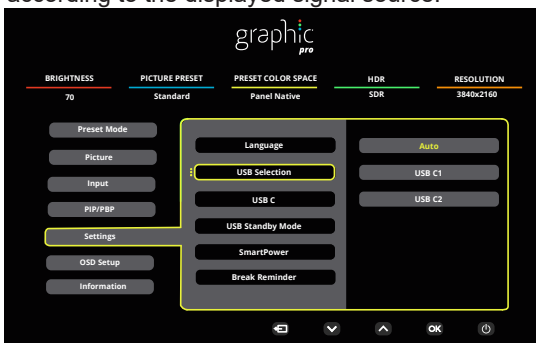

USB Selection	Function description
Auto	Automatically select USB C1 or USB C2 (USB upstream), depending on the signal source currently displayed on the screen.
USB C1	The USB upstream path is provided through the The USB C to USB C cable.
USB C2	The USB upstream path is provided through the USB C to USB A cable.

Note: In PIP/PBP display mode, please switch the USB upstream path through the OSD menu.

HDR

It is compatible with input signals in HDR10 format.

The display may automatically activate the HDR function if the player and content are compatible. Please contact the device manufacturer and the content provider for information on the compatibility of your device and content. Please select "OFF" for the HDR function when you have no need for automatical activation function.

Note:

1. No special setting is needed for the DisplayPort/HDMI interface in WIN10 versions lower (older) than V1703.
2. Only the HDMI interface is available and the DisplayPort interface cannot function in WIN10 version V1703.
3. Display Setting:
 - a. The display resolution is set to 3840x2160, and HDR is preset to ON.
 - b. After entering an application, the best HDR effect can be achieved when the resolution is changed to 3840x2160(if available).

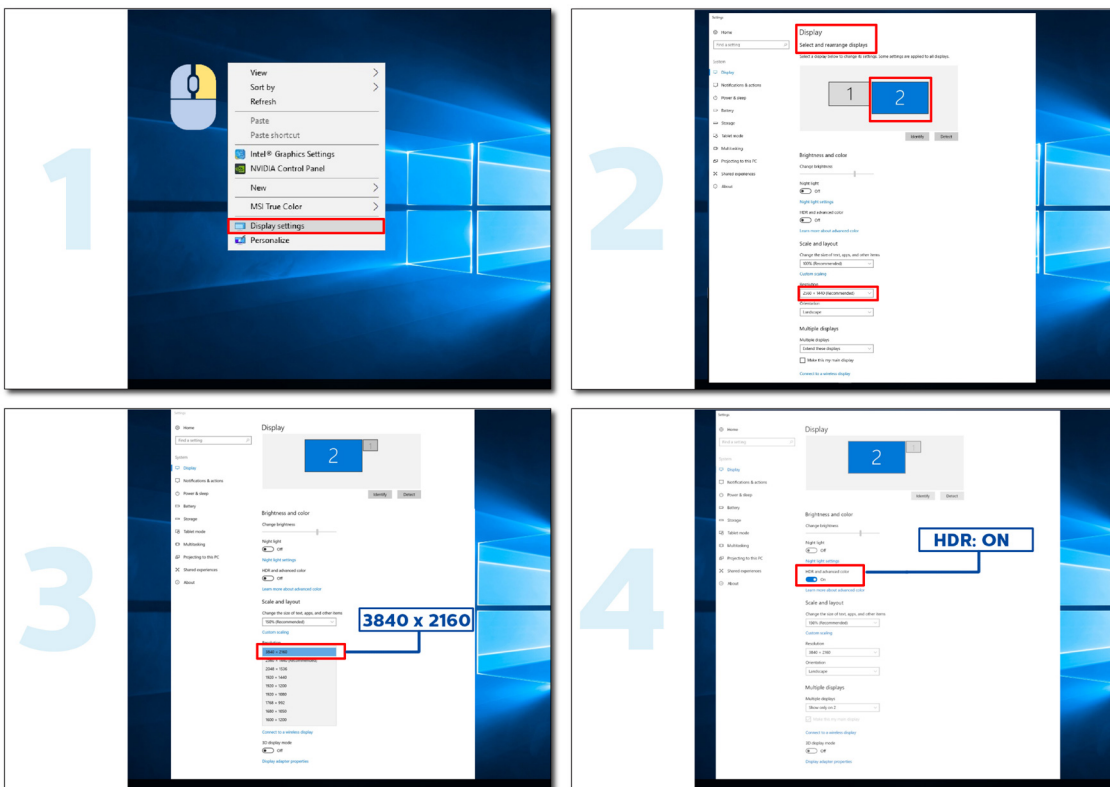

Calman ready



Calman Ready displays and devices are equipped with the ability to communicate directly with Portrait Displays' Calman® color calibration software. Devices that are Calman Ready can quickly connect with the software and leverage its precise and automated calibration capabilities (AutoCal™). Calman Ready allows for easy, precise and quick calibrations with your brand-new AOC display.

How to enable Calman Ready?

Calman Required Version:

Calman (Ultimate or Studio) Version 5.15.5.19 or later

Required Hardware

Calman Compatible Pattern Generator

*External HDR capable generator required for HDR calibration

Calman Compatible Meter

For information see : [Calman Compatible Meters](#)

Scan the following QR code to open the **AOC Monitor Calibration Workflow Guide** for instructions on calibrating compatible AOC Calman Ready monitors:



Note:

Once calibration is complete, the calibration will be stored in the monitor OSD under the Picture → CMR Color Space.

[NOTE: MOST CALMAN USERS ARE FAMILIAR WITH THE FOLLOWING INSTRUCTIONS SO WOULD SUGGEST THAT YOU CONSIDER THIS OPTIONAL FOR THE MANUAL]

Step 1:

Install your calman Tool.

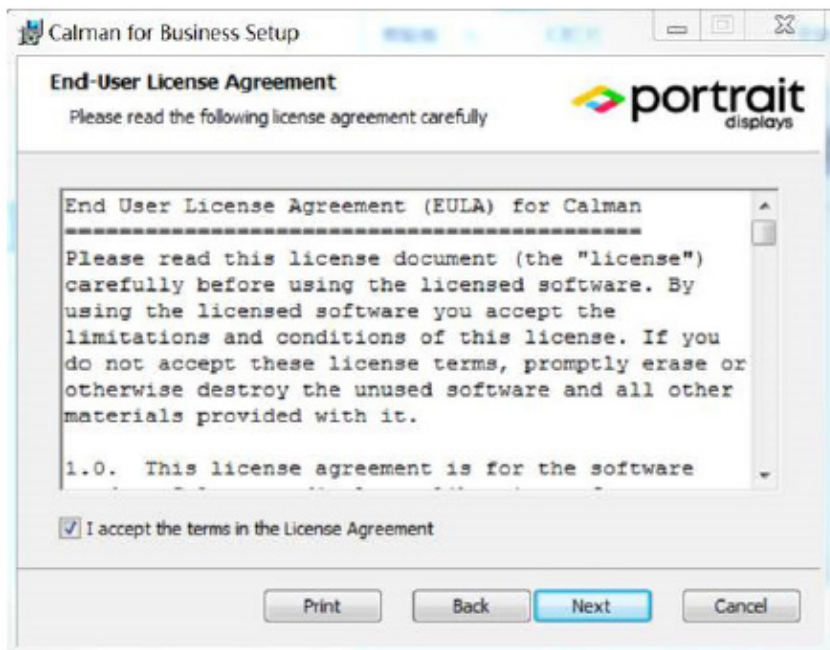
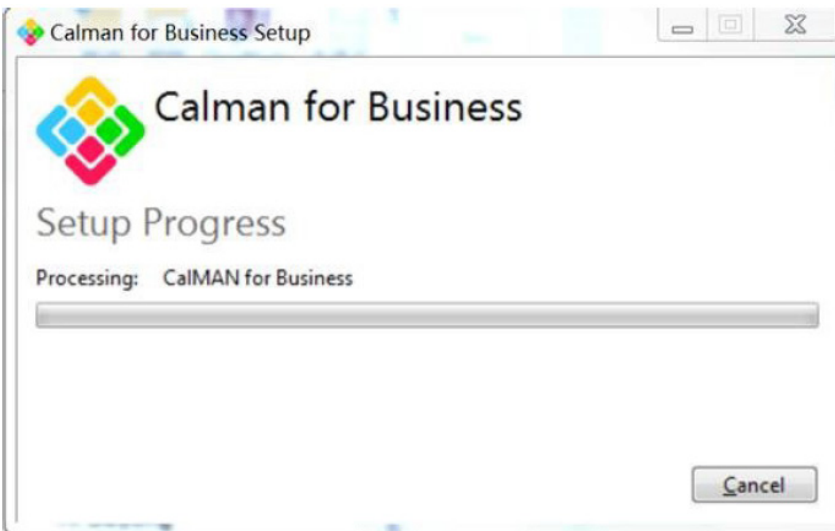
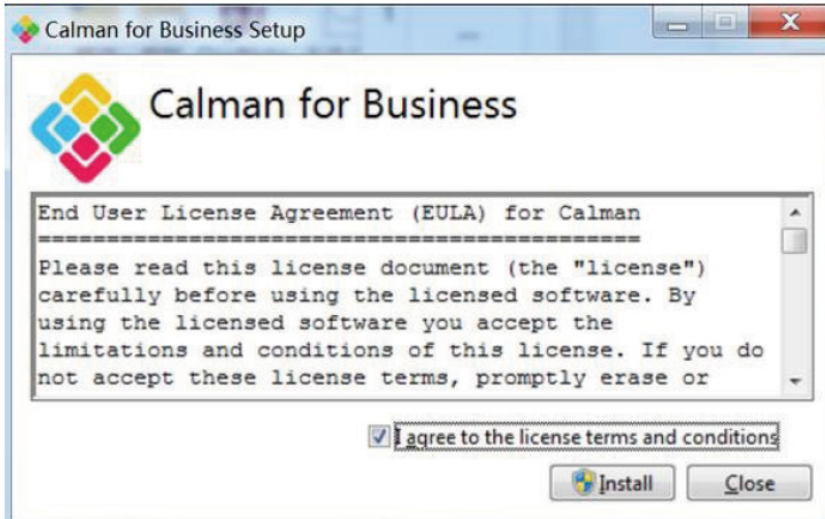

Step 2:

Enter your License ID and License Password, then click on the Activate Online button to activate your Calman license.

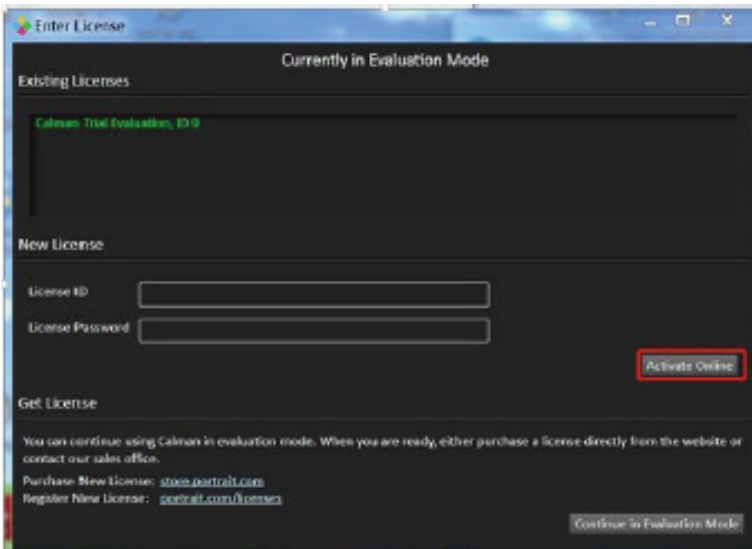

Step 3:

1. Connect the laptop to the monitor's USB C1 (bottom).
2. Connect a color meter to the laptop.
3. Open Calman and scan the following QR code to open the **AOC Monitor Calibration Walkthrough Guide** for instructions on calibrating compatible AOC Calman Ready monitors:



Note:

Once calibration is complete, the calibration will be stored in the monitor OSD under the Picture → CMR Color Space.

Adjusting

Hotkeys

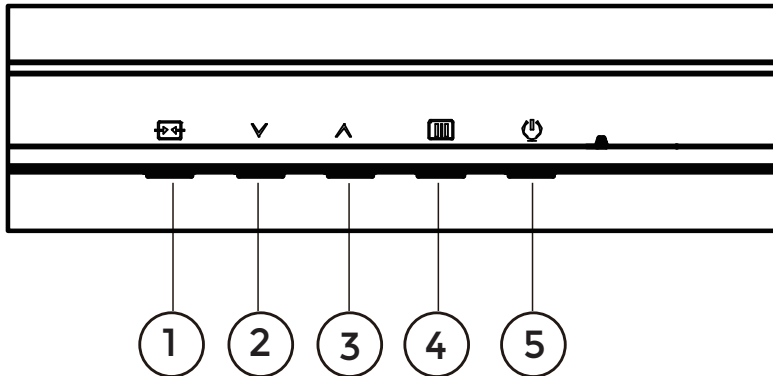

1	Source/Exit
2	Preset Mode/HDR
3	Brightness
4	Menu/Enter
5	Power

Menu/Enter

Press to display the OSD or confirm the selection.

Power

Press the Power button to turn on the monitor.

Brightness

When there is no OSD, press “ \wedge ” key to open brightness function, then press “ \vee ” or “ \wedge ” key to adjustment backlight.

Preset Mode / HDR

When there is no OSD, press “ \vee ” key to open preset mode function, then press “ \vee ” or “ \wedge ” key to choose different mode.

While receive HDR signal, Set the HDR profile according to your usage requirements.

Source/Exit

When the OSD is closed, press Source/Exit button will be Source hot key function.

When the OSD menu is active, this button acts as an exit key (to exit the OSD menu).

OSD Setting

Basic and simple instruction on the control keys.

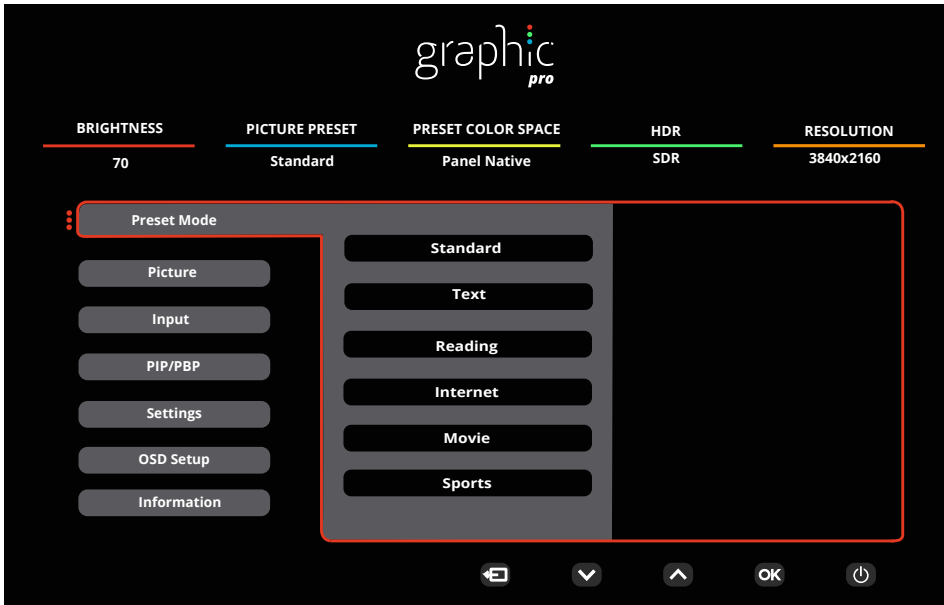

- 1). Press the **MENU-button** to activate the OSD window.
- 2). Press \downarrow or \uparrow to navigate through the functions. Once the desired function is highlighted, press the **MENU-button / OK** to activate it, press \downarrow or \uparrow to navigate through the sub-menu functions. Once the desired sub-menu function is highlighted, press **MENU-button / OK** to activate it.
- 3). Press \downarrow or \uparrow to change the settings of the selected function. Press \leftarrow / \rightarrow to exit. If you want to adjust any other function, repeat steps 2-3.
- 4). OSD Lock Function: To lock the OSD, press and hold the **MENU-button** while the monitor is off and then press power button to turn the monitor on. To unlock the OSD - press and hold the **MENU-button** while the monitor is off and then press power button to turn the monitor on.

Notes:

- 1). If the product has only one signal input, the item of "Input Select" is unable to be adjusted.
- 2). If the input signal resolution is the native resolution or Adaptive-Sync, then the item "Image Ratio" is invalid.

Preset Mode

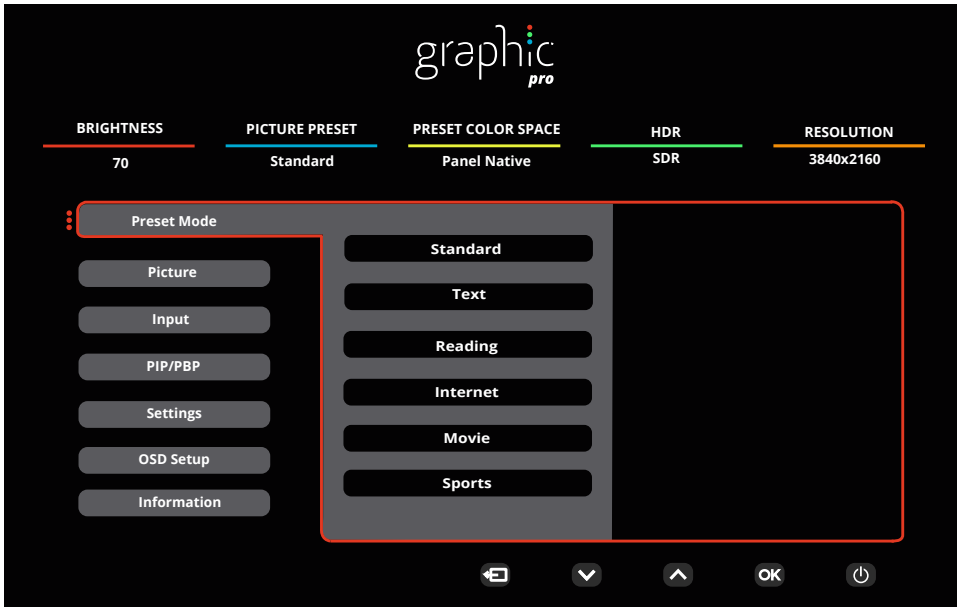

Preset Mode	Standard	Standard Mode
	Text	Text Mode
	Reading	Reading Mode
	Internet	Internet Mode
	Movie	Movie Mode
	Sports	Sports Mode
	Photographer	Photographer Mode
	HDR Picture	HDR simulation Picture Mode
	HDR Movie	HDR simulation Movie Mode
	HDR Game	HDR simulation Game Mode
	FPS	FPS Mode
	RTS	RTS Mode
	Racing	Racing Mode
	D-Mode	D-Mode Mode
	Uniformity	Uniformity Mode
Reset color	Yes / No Note: Resets the color settings to the factory defaults.	
HDR	Off	While receive HDR signal, Set the HDR profile according to your usage requirements. Note: When HDR is detected, the HDR option is displayed for adjustment.
	DisplayHDR	
	HDR Picture	
	HDR Movie	
	HDR Game	

Picture

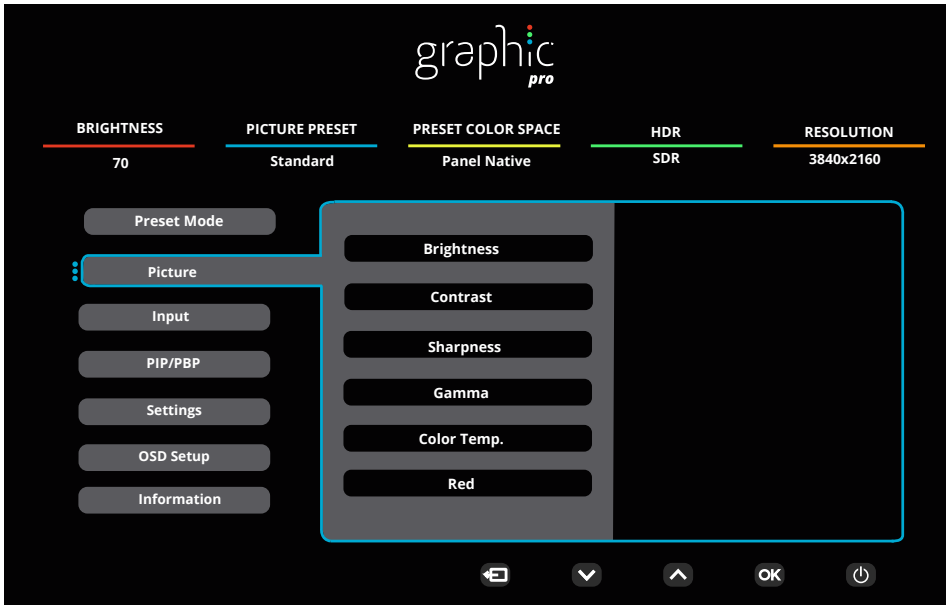

Brightness	0-100	Adjust brightness.
Contrast	0-100	Adjust contrast.
Sharpness	0-100	Adjust Sharpness.
Gamma	1.8 / 2.0 / 2.2 / 2.4 / 2.6	Adjust Gamma.
Color Temp.	Native / 5000K / 6500K 7500K / 8200K / 9300K 11500K / User define	Adjust Color Temp. Note: Select User define to adjust RGB colors.
Red	0-100	Red gain from Digital-register.
Green	0-100	Green gain from Digital-register.
Blue	0-100	Blue gain from Digital-register.
Saturation	R / G / B / C / M / Y	Adjustment 0-100.
Hue	R / G / B / C / M / Y	Adjustment 0-100.
Color Space	Panel Native	Adjust Color Space.
	sRGB	
	Display-P3	
	DCI-P3	
	DCI-P3 (D50)	
	Adobe RGB	
	Adobe RGB (D50)	
	Rec. 2020	
	Rec. 709	

CMR Color Space	sRGB	<p>Adjust CMR Color Space.</p> <p>Note: This feature is optional only after the color space of the machine is adjusted through the Calman tool (PC software) developed by Portrait.</p> <p>This product can be color-calibrated by using Calman color calibration software, and the hardware equipment needed for color calibration should be purchased separately according to Calman's suggestion.</p>
	Display-P3	
	DCI-P3	
	DCI-P3 (D50)	
	Adobe RGB	
	Adobe RGB (D50)	
	Rec. 2020	
	Rec. 709	
	Custom Mode	
HDR Color Space	DCI-P3	<p>Adjust HDR Color Space.</p> <p>Note: For CMR DCI-P3 & CMR Rec. 2020, this feature is optional only after the color space of the machine is adjusted through the Calman tool (PC software) developed by Portrait.</p> <p>This product can be color-calibrated by using Calman color calibration software, and the hardware equipment needed for color calibration should be purchased separately according to Calman's suggestion.</p>
	Rec. 2020	
	CMR DCI-P3	
	CMR Rec. 2020	
DCR	Off / On	Disable or Enable dynamic contrast ratio.
Local Dimming	Off / On	<p>Disable or Enable Local Dimming.</p> <p>Note:</p> <p>Local Dimming is disable under SDR signal and is in default On HDR signal.</p>
Clear Vision	Off	Adjust Clear Vision.
	Weak	
	Medium	
	Strong	
Lowblue Mode	Off	Decrease blue light wave by controlling color temperature.
	Multimedia	
	Internet	
	Office	
	Reading	
Image Ratio	Full / Aspect / 1:1	<p>Select image ratio for display.</p> <p>Note:</p> <p>1) The state is full screen by default, and any display mode can be selected;</p> <p>2) The screen ratio can be selected except the main frequency and the display mode with the same ratio as the panel screen;</p> <p>3) All display modes can be selected in the ratio of 1:1 except the main frequency.</p>

Over Scan	Off / On	Disable or Enable Over Scan.
Shadow Boost	Off / Level 10 / Level 20 / Level 30	Enhance the screen details in the dark or bright area to adjust the brightness in the bright area and ensure that it is not oversaturated.
Shadow Control	0 ~ 100	Shadow Control Default is 50, then end-user can adjust from 50 to 100 or 0 to 50 to increase/ decrease contrast for a clearer picture. 1. If picture is too dark to be saw the detail clearly, adjusting from 50 to 100 for a clearer picture. 2. If picture is too white to be saw the detail clearly, adjusting from 50 to 0 for a clearer picture.
Game Color	0 ~ 20	Game Color will provide 0-20 level for adjusting saturation to get a better picture.
Adaptive-Sync	Off / On	Disable or Enable Adaptive-Sync. Adaptive-Sync Run Reminder: When the Adaptive-Sync feature is enabled, there may be flashing in some game environments.
Overdrive	Off / Weak / Medium / Strong	Adjust the response time.

Note: When the Local Dimming function is activated, due to the light diffusion effect. The edges of windows or the edges of moving objects there will be a slight halo phenomenon. This is the physical characteristics of the LED panel is not a panel failure phenomenon, please rest assured to continue using.

Input

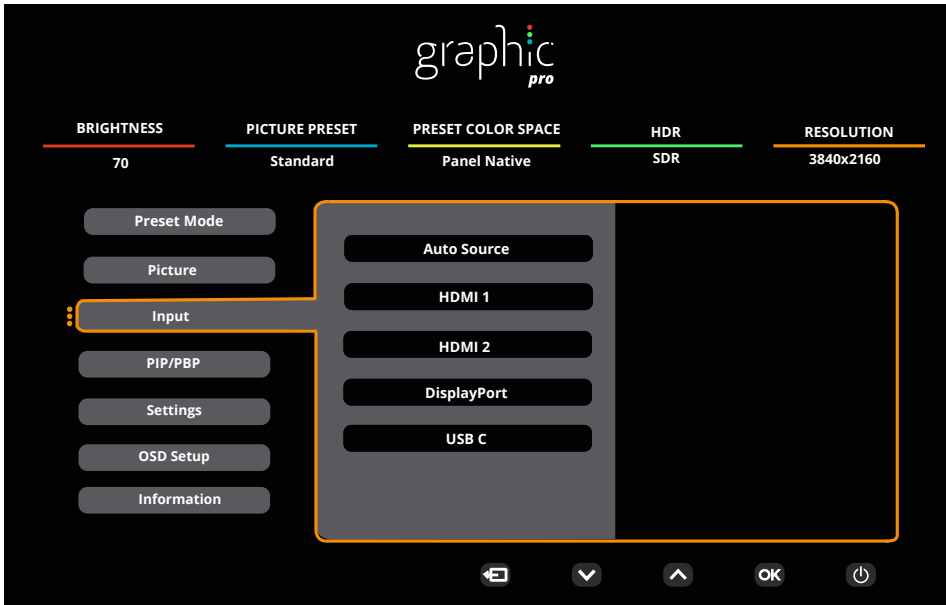

Auto Source	Off / On	Disable / Enable Auto Source.
HDMI 1		Select Input Signal Source.
HDMI 2		
DisplayPort		
USB C		

Note:

It is recommended to keep Auto Source enabled.

PIP/PBP

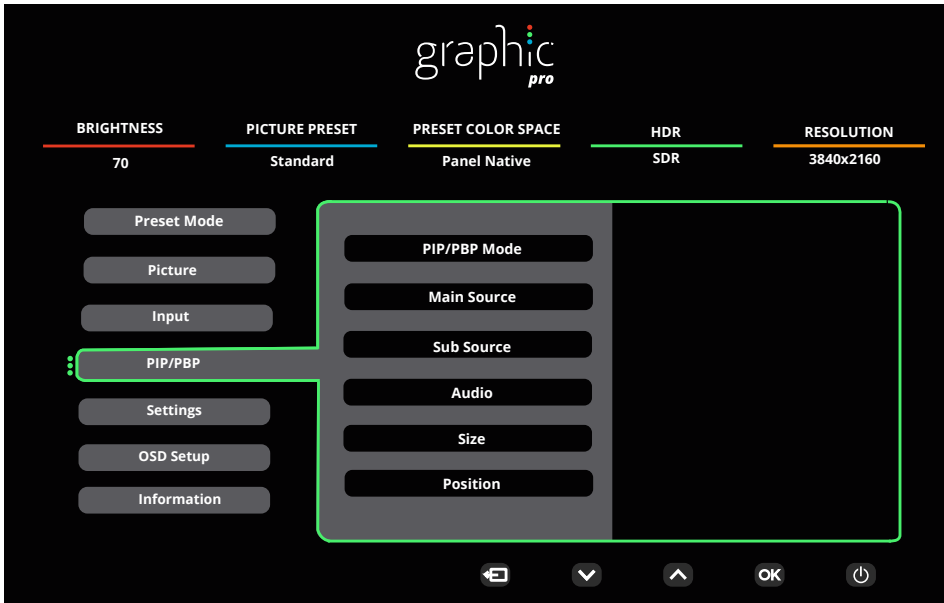

PIP / PBP Mode	Off / PIP / PBP	Disable or Enable PIP or PBP.
Main Source	HDMI1 / HDMI2 / DisplayPort / USB C	Select main screen source.
Sub Source	HDMI1 / HDMI2 / DisplayPort / USB C	Select sub screen source.
Audio	Main Source/Sub Source	Select the audio output under different sources.
Size	Small / Middle / Large	Select screen size.
Position	Right-up	Set the screen location.
	Right-down	
	Left-up	
	Left-down	
Swap	Off / On	Select Off/On to Disable/Enable Swap.

Notes:

- 1). When "HDR" is set to a non-off state, all items under "PIP/PBP" can not be adjusted.
- 2) When PIP/PBP is enabled, some color-related adjustments in the OSD menu are valid only for the main screen, while the sub-screen is not supported. Hence, the main screen and the sub-screen may have different colors.
- 3). When PBP/PIP is On, the Main source / Sub-source input source compatibility is as follow:

PIP		Sub source			
		HDMI1	HDMI2	DisplayPort	USB C
Main source	HDMI1	V	V	V	V
	HDMI2	V	V	V	V
	DisplayPort	V	V	V	V
	USB C	V	V	V	V

PBP		Sub source			
		HDMI1	HDMI2	DisplayPort	USB C
Main source	HDMI1	V	V	V	V
	HDMI2	V	V	V	V
	DisplayPort	V	V	V	V
	USB C	V	V	V	V

Settings

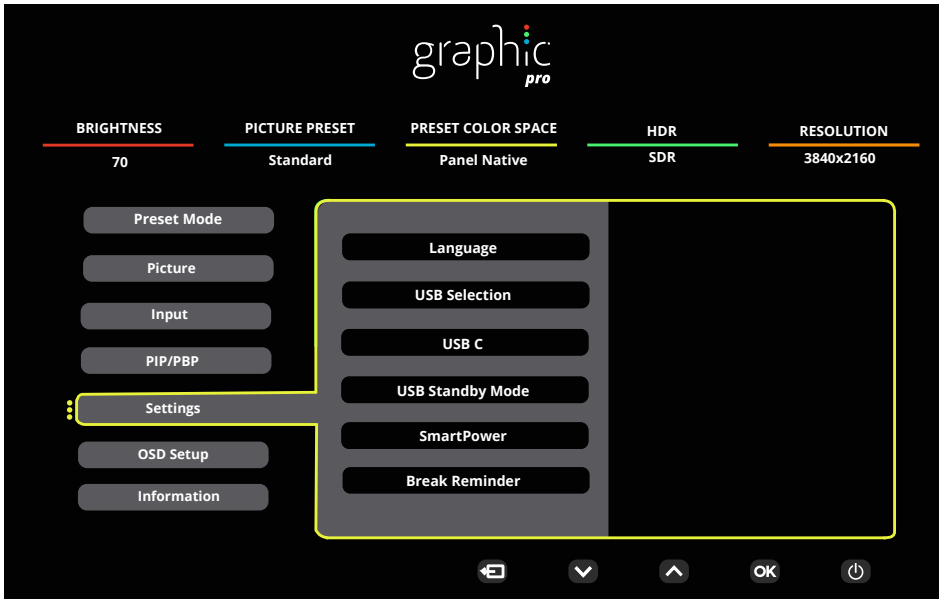

Language	English/Français/Español/ Português/Deutsch/Italiano/ Nederlands/Svenska/Suomi/ Polski/Čeština/Русский/ 한국어 /Türkçe/Українська/ 繁 體中文 / 简体中文 / 日本語	Select the OSD language.
USB Selection	Auto / USB C1 / USB C2	Select the USB upstream data path.
USB C	High Data Speed / High Resolution	Set the USB connector data transmission priority or resolution priority.
USB Standby Mode	Off / On	Turn On/Off USB Standby Mode.
SmartPower	Off / On	Turn On/Off SmartPower.
Break Reminder	Off / On	Break reminder if the user continuously work for more than 1hrs
Off Timer (hr)	00-24	Select DC Off time.
DDC/CI	No / Yes	Turn On/Off DDC/CI Support.
Volume	0~100	Volume Adjustment.
Mute	Off / On	Mute the volume.
Resolution Notice	Off / On	Turn On/Off Resolution Notice.
Reset	No / ENERGY STAR [®]	Reset the menu to default.

Notes:

USB C1 Different profile table:

Smart Power	OSD Setting	USB C1 PD profile	USB-Hub	Brightness
On (HDR On / SDR On)	No OSD Smart power Auto	65W	FULL function	0~100
On (SDR On)	No OSD Smart power Auto	96W	USB<10W	0~100
Off (HDR Off)	Smart Power Off	65W	USB<10W	0~100

OSD Setup

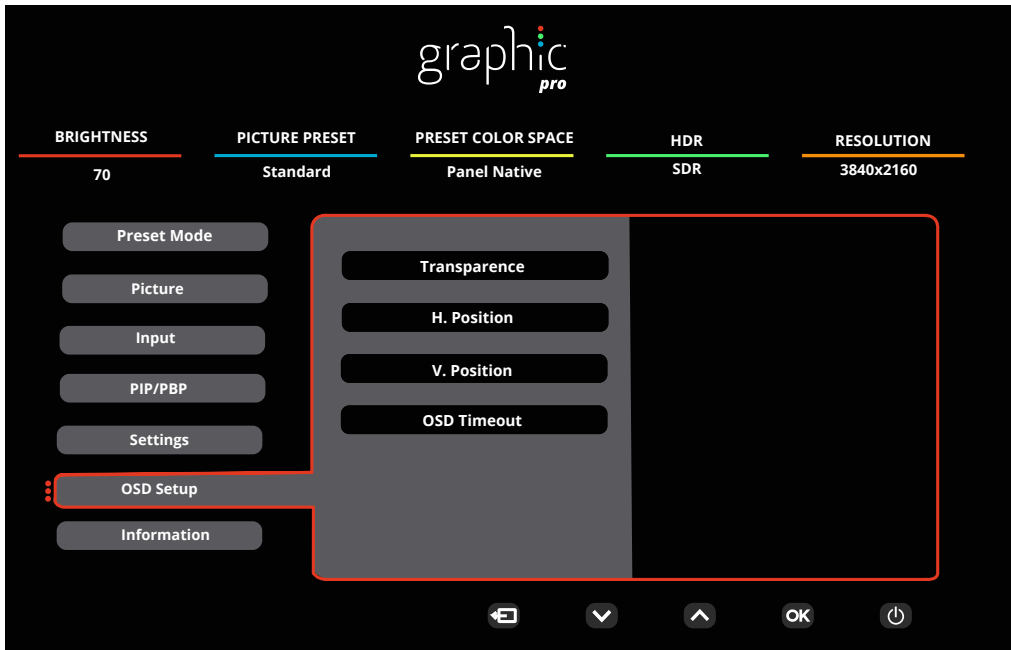

Transparence	0-100	Adjust the transparence of OSD.
H. Position	0-100	Adjust the horizontal position of OSD.
V. Position	0-100	Adjust the vertical position of OSD.
OSD Timeout	5-120	Adjust the OSD Timeout.

Information

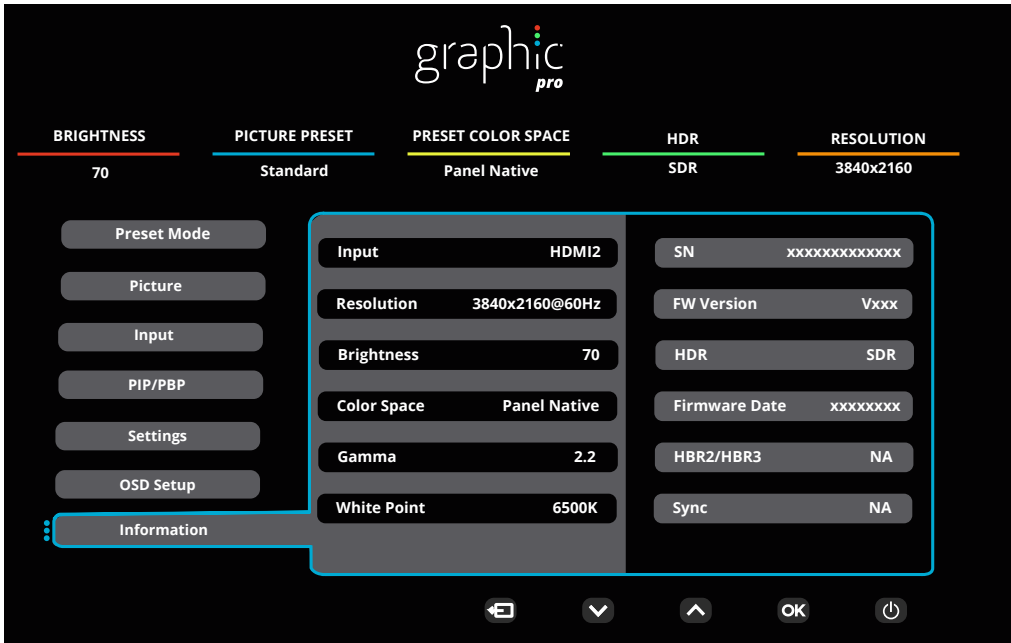

LED Indicator

Status	LED Color
Full Power Mode	White
Active-off Mode	Orange

Troubleshoot

Problem & Question	Possible Solutions
Power LED Is Not ON	Make sure the power button is ON and the Power Cord is properly connected to a grounded power outlet and to the monitor.
No image on the screen	<ul style="list-style-type: none"> • Is the power cord connected properly? Check the power cord connection and power supply. • Is the video cable connected correctly? (Connected using the HDMI cable) Check the HDMI cable connection. (Connected using the DisplayPort cable) Check the DisplayPort cable connection. * HDMI/DisplayPort input is not available on every model. • If the power is on, reboot the computer to see the initial screen (the login screen.) If the initial screen (the login screen) appears, boot the computer in the applicable mode (the safe mode for Windows 7/8/10) and then change the frequency of the video card. (Refer to the Setting the Optimal Resolution) If the initial screen (the login screen) does not appear, contact the Service Center or your dealer. • Can you see "Input Not Supported" on the screen? You can see this message when the signal from the video card exceeds the maximum resolution and frequency that the monitor can handle properly. Adjust the maximum resolution and frequency that the monitor can handle properly. • Make sure the AOC Monitor Drivers are installed.
Picture Is Fuzzy & Has Ghosting Shadowing Problem	Adjust the Contrast and Brightness Controls. Press hot-key (AUTO) to auto-adjust. Make sure you are not using an extension cable or switch box. We recommend plugging the monitor directly to the video card output connector on the back.
Picture Bounces, Flickers Or Wave Pattern Appears In The Picture	Move electrical devices that may cause electrical interference as far away from the monitor as possible. Use the maximum refresh rate your monitor is capable of at the resolution you are using.
Monitor Is Stuck In Active Off-Mode"	The Computer Power Switch should be in the ON position. The Computer Video Card should be snugly fitted in its slot. Make sure the monitor's video cable is properly connected to the computer. Inspect the monitor's video cable and make sure no pin is bent. Make sure your computer is operational by hitting the CAPS LOCK key on the keyboard while observing the CAPS LOCK LED. The LED should either turn ON or OFF after hitting the CAPS LOCK key.
Missing one of the primary colors (RED, GREEN, or BLUE)	Inspect the monitor's video cable and make sure that no pin is damaged. Make sure the monitor's video cable is properly connected to the computer.
Screen image is not centered or sized properly	Adjust H-Position and V-Position or press hot-key (AUTO).
Picture has color defects (white does not look white)	Adjust RGB color or select desired color temperature.
Horizontal or vertical disturbances on the screen	Use Windows 7/8/10/11 shut-down mode to adjust CLOCK and FOCUS. Press hot-key (AUTO) to auto-adjust.
Regulation & Service	Please refer to Regulation & Service Information which is in the CD manual or www.aoc.com (to find the model you purchase in your country and to find Regulation & Service Information in Support page).

Specification

General Specification

Panel	Model name	U32U3CV	
	Driving system	TFT Color LCD	
	Viewable Image Size	80.0 cm diagonal(31.5" Wide Screen)	
	Pixel pitch	0.18159mm(H) x 0.18159mm(V)	
	Display Color	1.07B Colors ^[1]	
Others	Horizontal scan range	30k~140kHz	
	Horizontal scan Size(Maximum)	697.3mm	
	Vertical scan range	23~75Hz	
	Vertical Scan Size(Maximum)	392.2mm	
	Optimal preset resolution	3840x2160@60Hz	
	Max resolution	3840x2160@60Hz ^[2]	
	Plug & Play	VESA DDC2B/CI	
	Power Source	100-240V~ 50/60Hz 3.0A	
	Power Consumption	Typical(default brightness and contrast)	46W
Max. (brightness = 100, contrast =100)		≤215W	
Standby mode		≤0.3W	
Physical Characteristics	Connector Type	HDMIx2, DisplayPort, RJ-45, Earphone, USB C1: Video,PD 96W USB C2: Upstream USB C(Side): Power supply up to 15W USB-Ax4 (side for fast-charge)	
	Signal Cable Type	Detachable	
	Built-In Speaker	3Wx2	
Environmental	Temperature	Operating	0°C~40°C
		Non-Operating	-25°C~55°C
	Humidity	Operating	10%~85% (Non-Condensing)
		Non-Operating	5%~93% (Non-Condensing)
	Altitude	Operating	0m~5000m (0ft~16404ft)
		Non-Operating	0m~12192m (0ft~40000ft)



[1] Color Bit table: ("V":support, "\":nonsupport)

Signal Version Color Format State Color Bit	HDMI2.0		DP1.4		USB C / USB High Data Speed		USB C / USB High-res	
	YCbCr420	YCbCr444	YCbCr420	YCbCr444	YCbCr420	YCbCr444	YCbCr420	YCbCr444
	YCbCr422	RGB	YCbCr422	RGB	YCbCr422	RGB	YCbCr422	RGB
UHD 60Hz 10 bpc	V	\	V	V	V	\	V	V
UHD 60Hz 8 bpc	V	V	V	V	V	V	V	V
QHD 60Hz 10 bpc	V	V	V	V	V	V	V	V
QHD 60Hz 8 bpc	V	V	V	V	V	V	\	V

Note: Windows operating systems with 8bit+YCbCr422 and later do not support HDR .

[2] In High Data Speed mode, 3840x2160@60Hz+10bit+YCbCr444 is not supported.

Preset Display Modes

STANDARD	RESOLUTION(±1Hz)	HORIZONTAL FREQUENCY(KHz)	VERTICAL FREQUENCY(Hz)
DOS MODE	720x400@70Hz	31.469	70.087
VGA	640x480@60Hz	31.469	59.94
	640x480@67Hz	35	66.667
	640x480@72Hz	37.861	72.809
	640x480@75Hz	37.5	75
SVGA	800x600@56Hz	35.156	56.25
	800x600@60Hz	37.879	60.317
	800x600@72Hz	48.077	72.188
	800x600@75Hz	46.875	75
MAC MODES	832X624@75Hz	49.725	74.551
XGA	1024x768@60Hz	48.363	60.004
	1024x768@70Hz	56.476	70.069
	1024x768@75Hz	60.023	75.029
SXGA	1280x1024@60Hz	63.981	60.02
	1280x1024@75Hz	79.976	75.025
WXGA+	1440x900@60Hz	55.935	59.887
	1440x900@60Hz	55.469	59.901
WSXGA	1680x1050@60Hz	65.29	59.954
	1680x1050@60Hz	64.674	59.883
FHD	1920x1080@60Hz	67.5	60
QHD	2560x1440@60Hz	88.787	59.951
PBP Mode	1920x2160@60Hz	133.293	59.988
UHD	3840x2160@30Hz	67.5	30
	3840x2160@60Hz	135	60

Note: According to the VESA standard, there may be a certain error (+/-1Hz) when calculating the refresh rate (field frequency) of different operating systems and graphics cards. In order to improve compatibility, the nominal refresh rate of this product has been rounded off. Please refer to the actual product.

Pin Assignments



19-Pin Color Display Signal Cable

Pin No.	Signal Name	Pin No.	Signal Name	Pin No.	Signal Name
1.	TMDS Data 2+	9.	TMDS Data 0-	17.	DDC/CEC Ground
2.	TMDS Data 2 Shield	10.	TMDS Clock +	18.	+5V Power
3.	TMDS Data 2-	11.	TMDS Clock Shield	19.	Hot Plug Detect
4.	TMDS Data 1+	12.	TMDS Clock-		
5.	TMDS Data 1Shield	13.	CEC		
6.	TMDS Data 1-	14.	Reserved (N.C. on device)		
7.	TMDS Data 0+	15.	SCL		
8.	TMDS Data 0 Shield	16.	SDA		

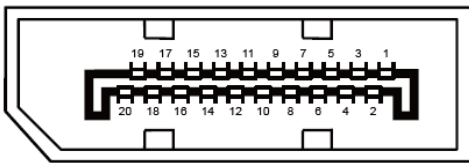

20-Pin Color Display Signal Cable

Pin No.	Signal Name	Pin No.	Signal Name
1	ML_Lane 3 (n)	11	GND
2	GND	12	ML_Lane 0 (p)
3	ML_Lane 3 (p)	13	CONFIG1
4	ML_Lane 2 (n)	14	CONFIG2
5	GND	15	AUX_CH(p)
6	ML_Lane 2 (p)	16	GND
7	ML_Lane 1 (n)	17	AUX_CH(n)
8	GND	18	Hot Plug Detect
9	ML_Lane 1 (p)	19	Return DP_PWR
10	ML_Lane 0 (n)	20	DP_PWR

Plug and Play

Plug & Play DDC2B Feature

This monitor is equipped with VESA DDC2B capabilities according to the VESA DDC STANDARD. It allows the monitor to inform the host system of its identity and, depending on the level of DDC used, communicate additional information about its display capabilities.

The DDC2B is a bi-directional data channel based on the I2C protocol. The host can request EDID information over the DDC2B channel.

