

RU16DT

1600mm Straight Reception Desk

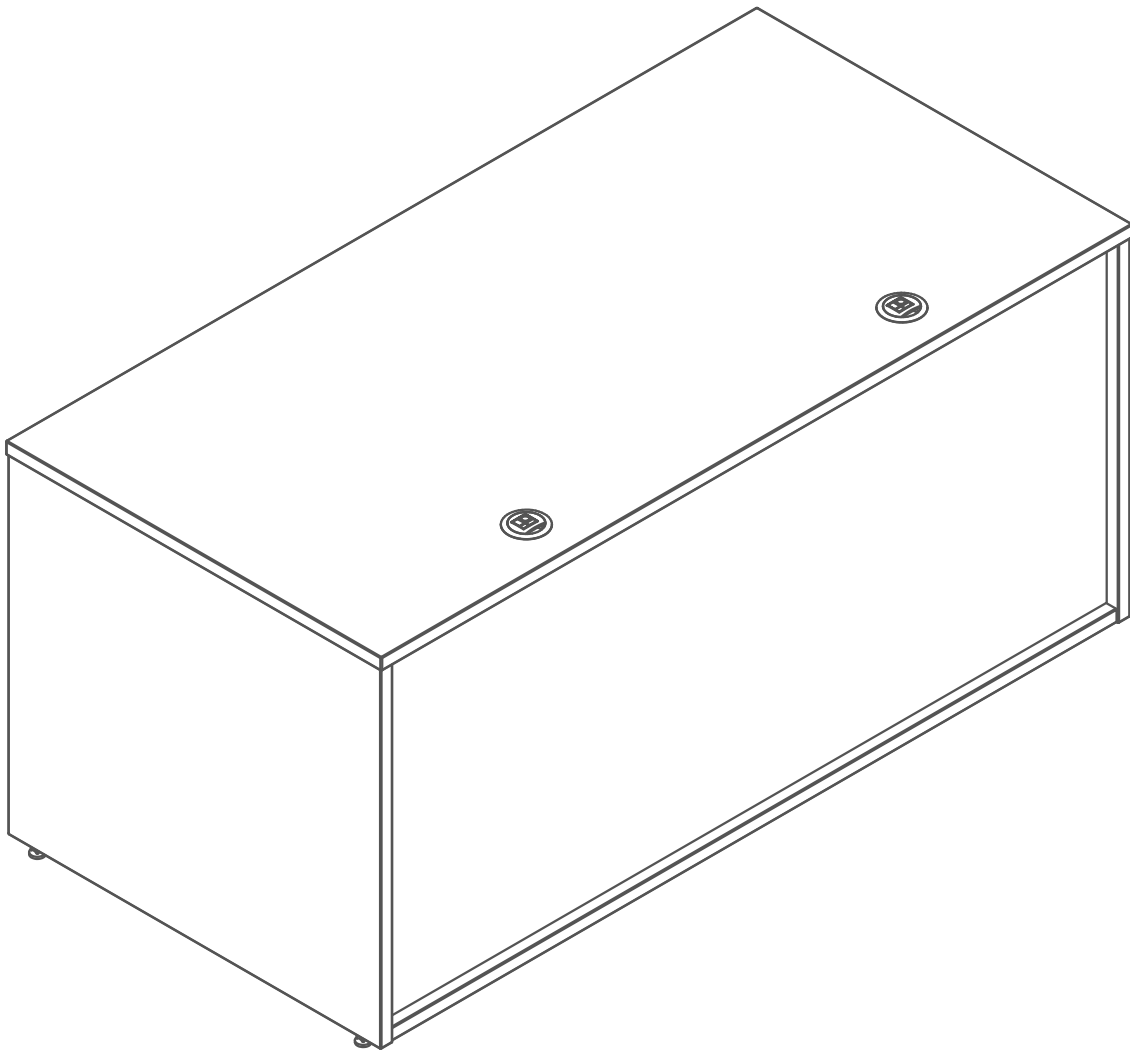

**TOOLS REQUIRED
FOR ASSEMBLY**

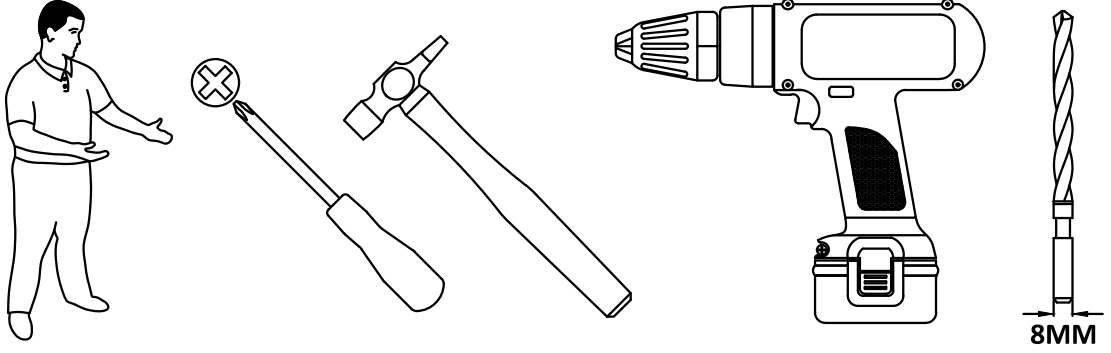

**DONT STRUGGLE
2 MAN LIFT**

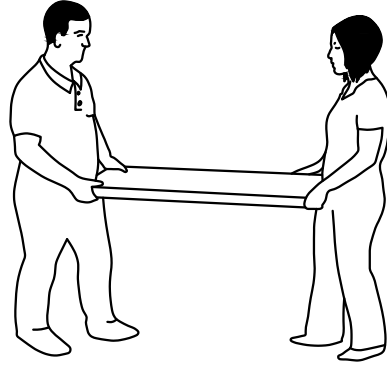
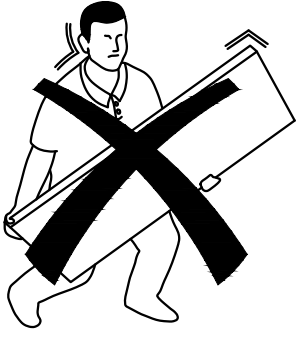

**ALWAYS HANDLE
ITEMS WITH CARE**

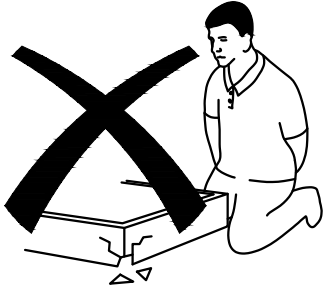

**IF UNSURE CALL
FOR ASSISTANCE**

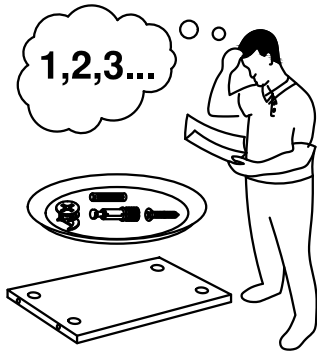

**KEEP FITTINGS AWAY
FROM CHILDREN**

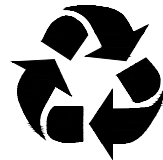
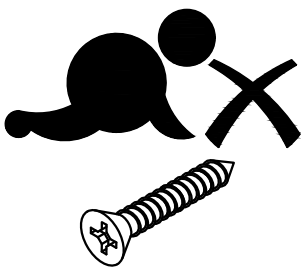



Please check that you have all the panels!

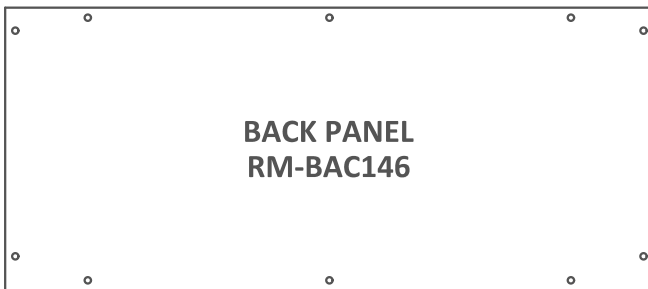
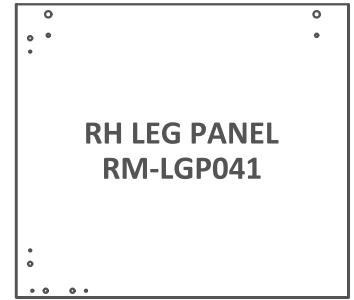
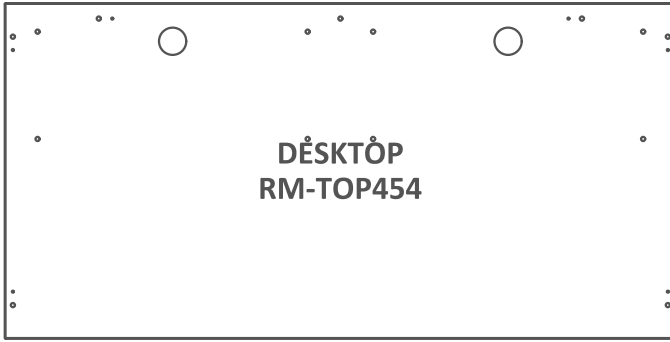

Please check that you have all the fittings!

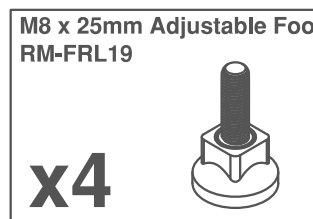
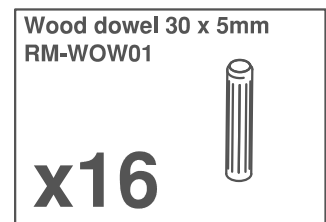
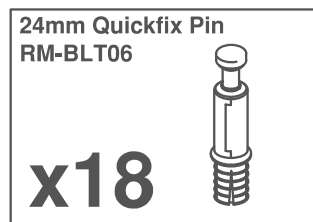
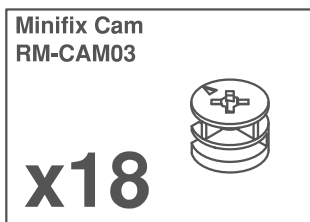

1

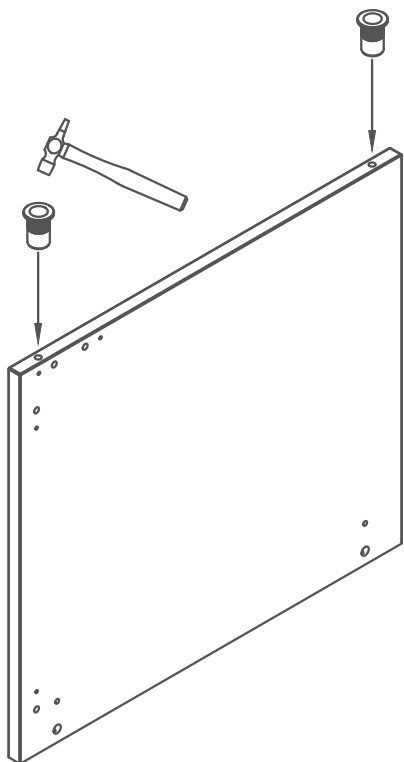

M8 Gesipa Insert
RM-NUT04

x4



2

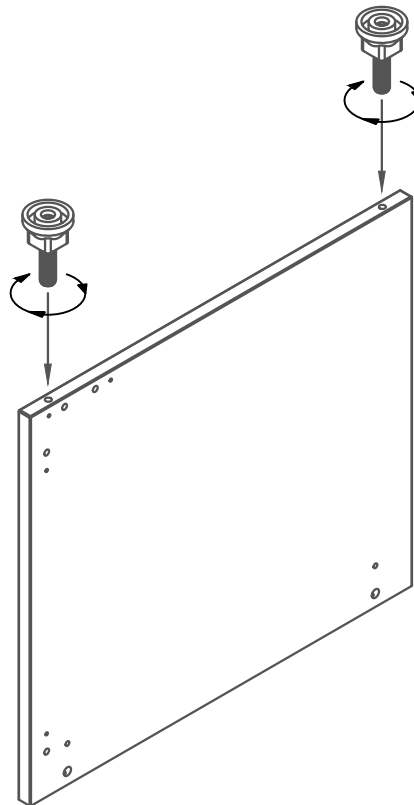

M8 x 25mm Adj Foot
RM-FRL19

x4



3

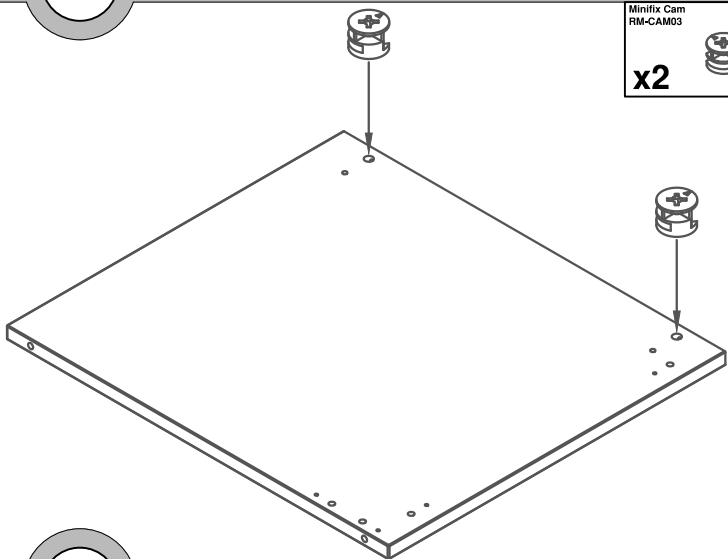

Minifix Cam
RM-CAM03

x2



4

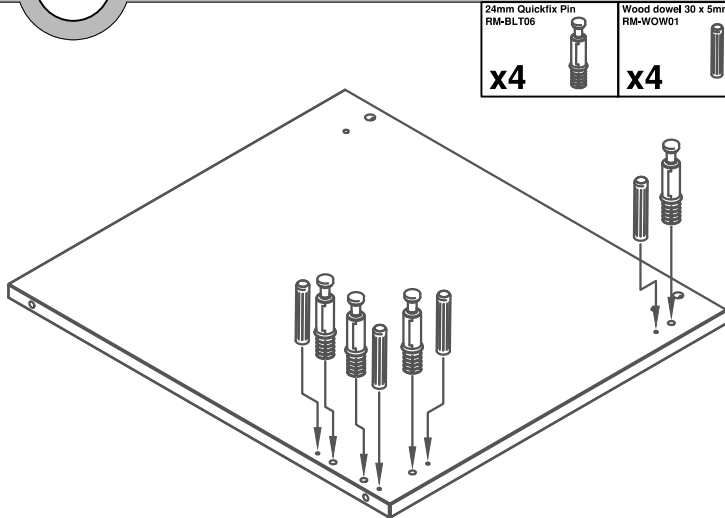

24mm Quickfix Pin
RM-BLT06

x4



Wood dowel 30 x 5mm
RM-WOW01

x4



5

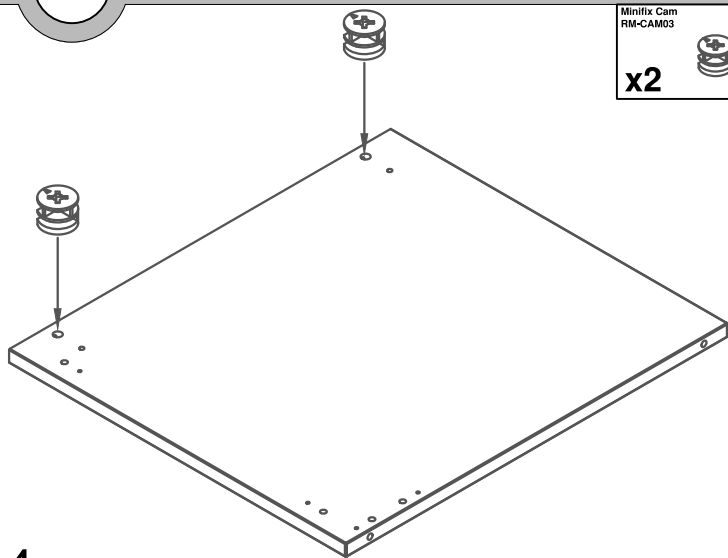

Minifix Cam
RM-CAM03

x2



6

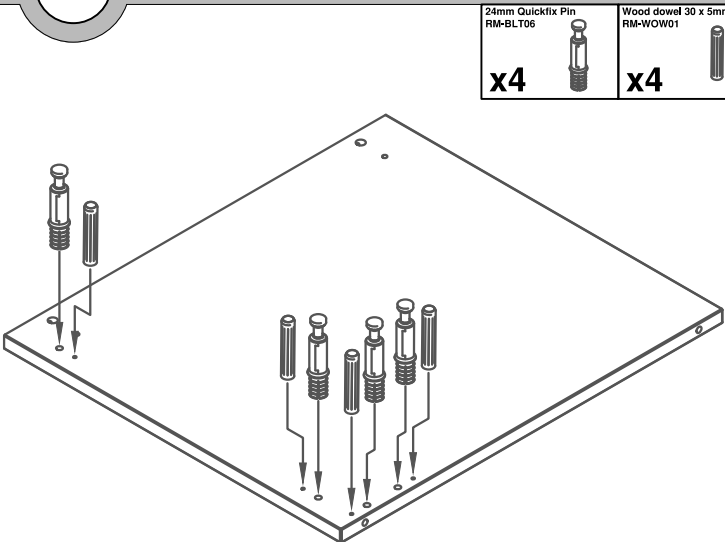

24mm Quickfix Pin
RM-BLT06

x4



Wood dowel 30 x 5mm
RM-WOW01

x4



7

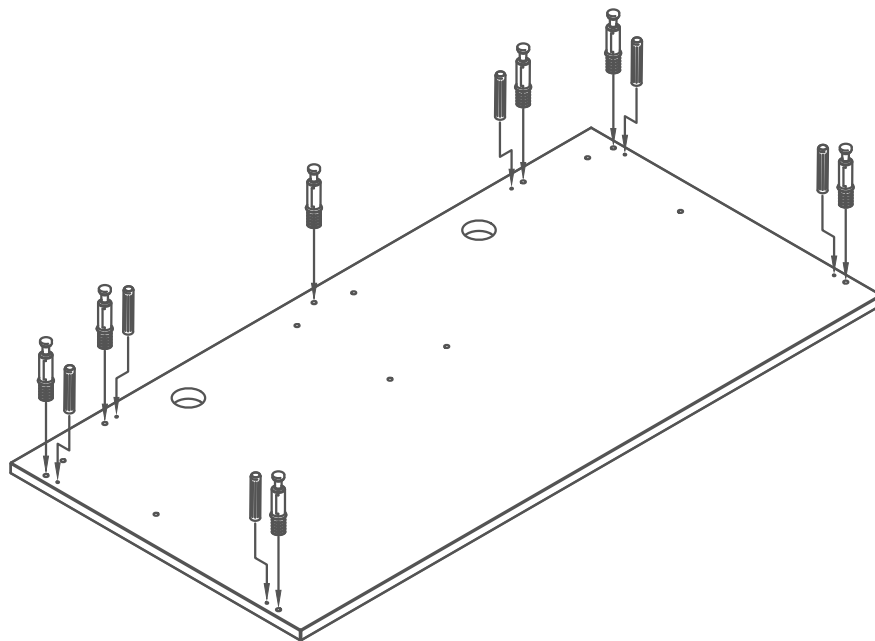

24mm Quickfix Pin RM-BLT05	Wood dowel 30 x 5mm RM-WOW01
x7	x6

8

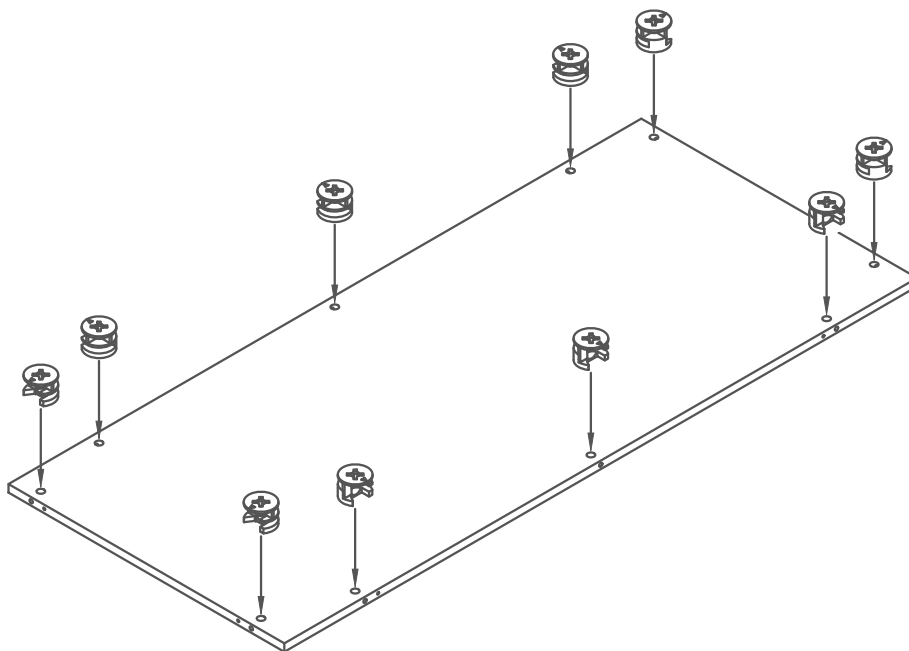

Minifix Cam RM-CAM03
x10

9

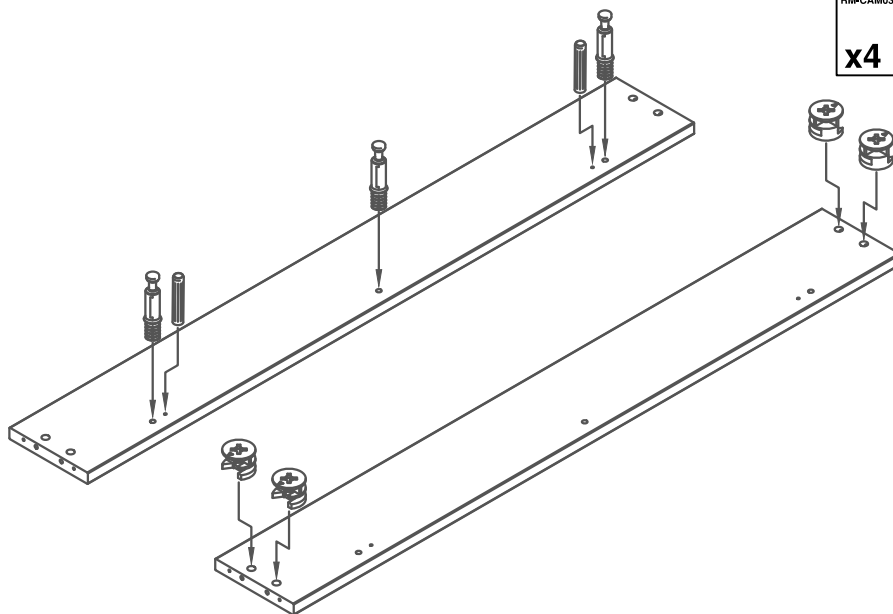

Minifix Cam RM-CAM03	24mm Quickfix Pin RM-BLT05	Wood dowel 30 x 5mm RM-WOW01
x4	x3	x2

10

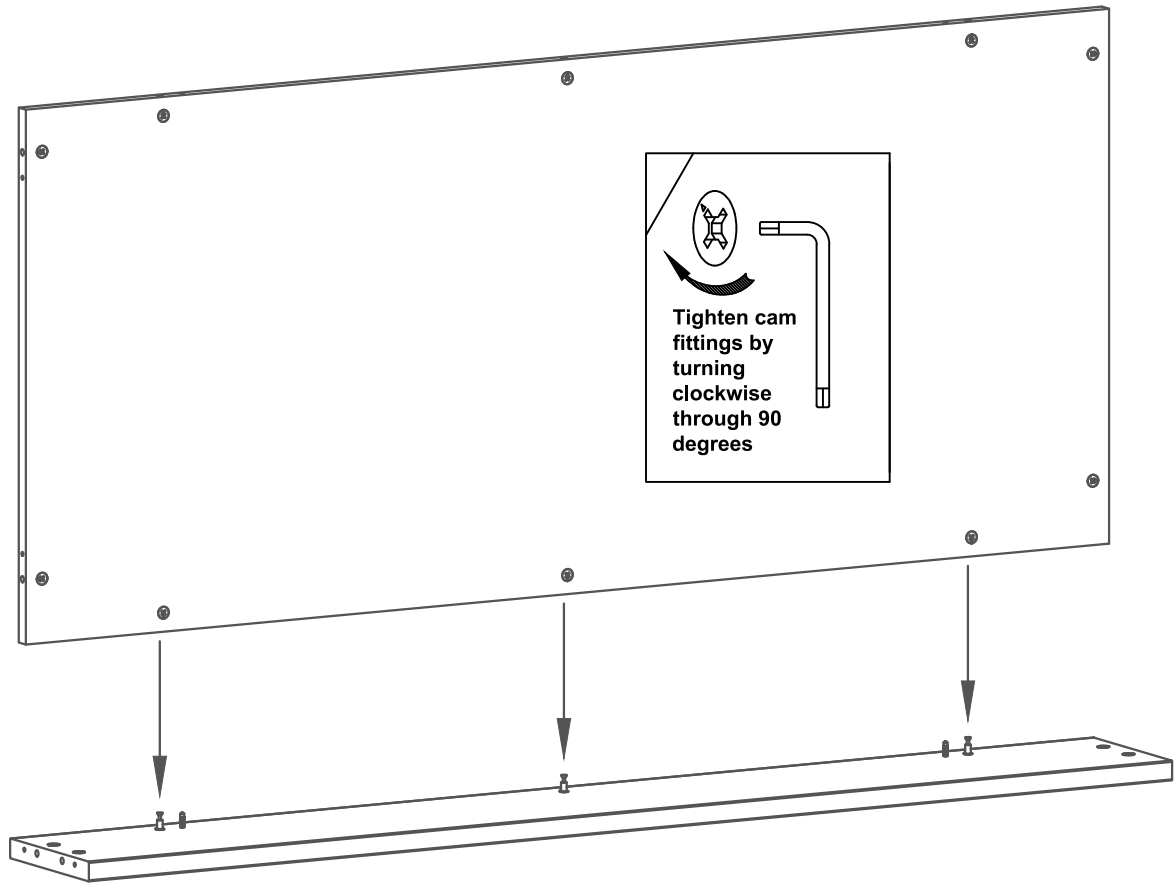

11

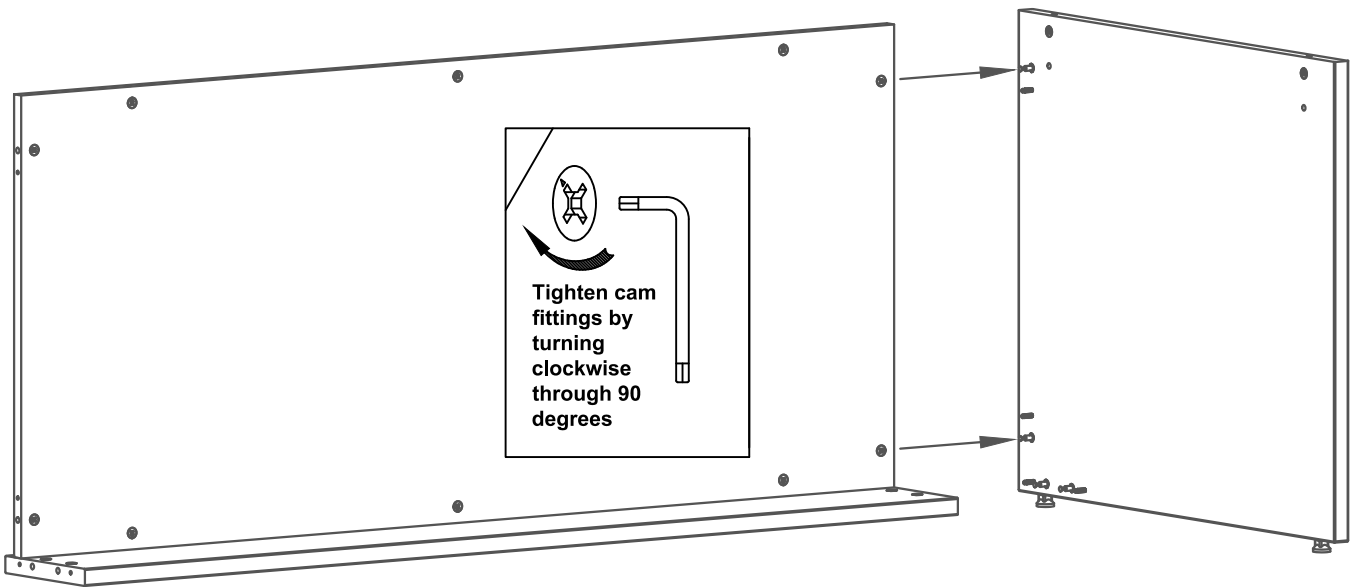

12

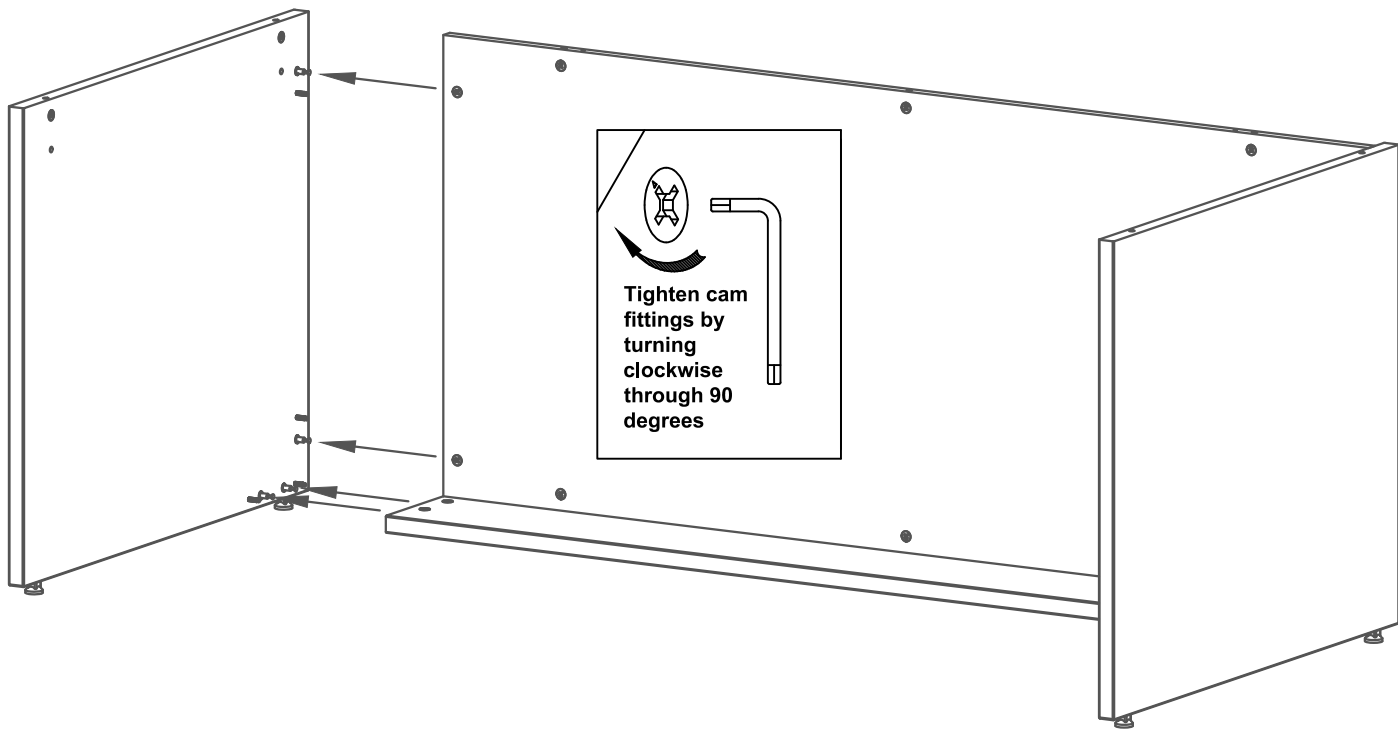

13

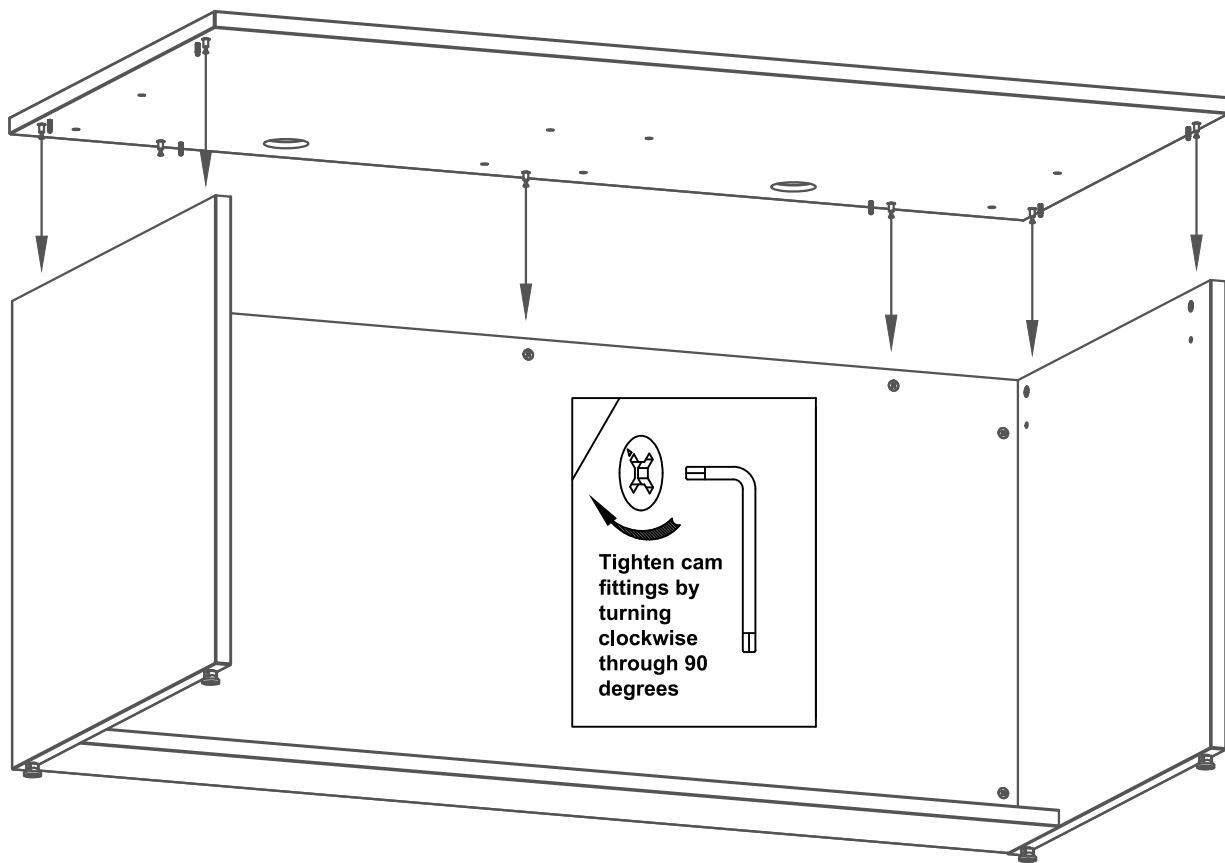



Linking units together

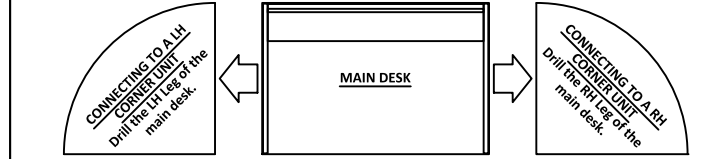
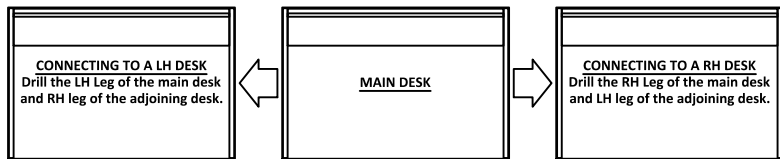
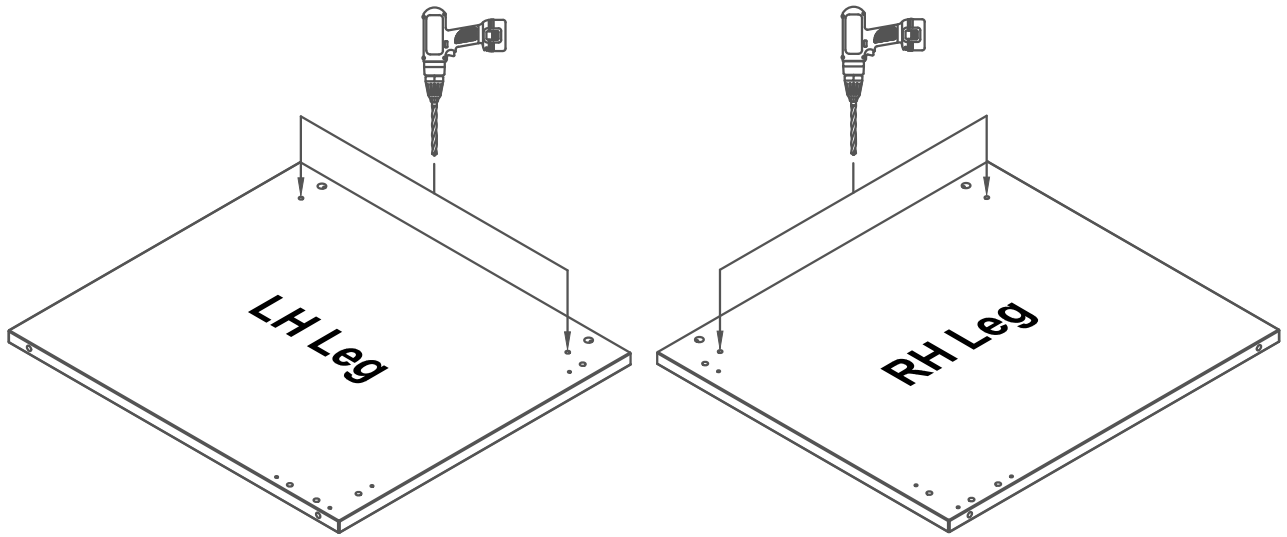

Linking desk to desk

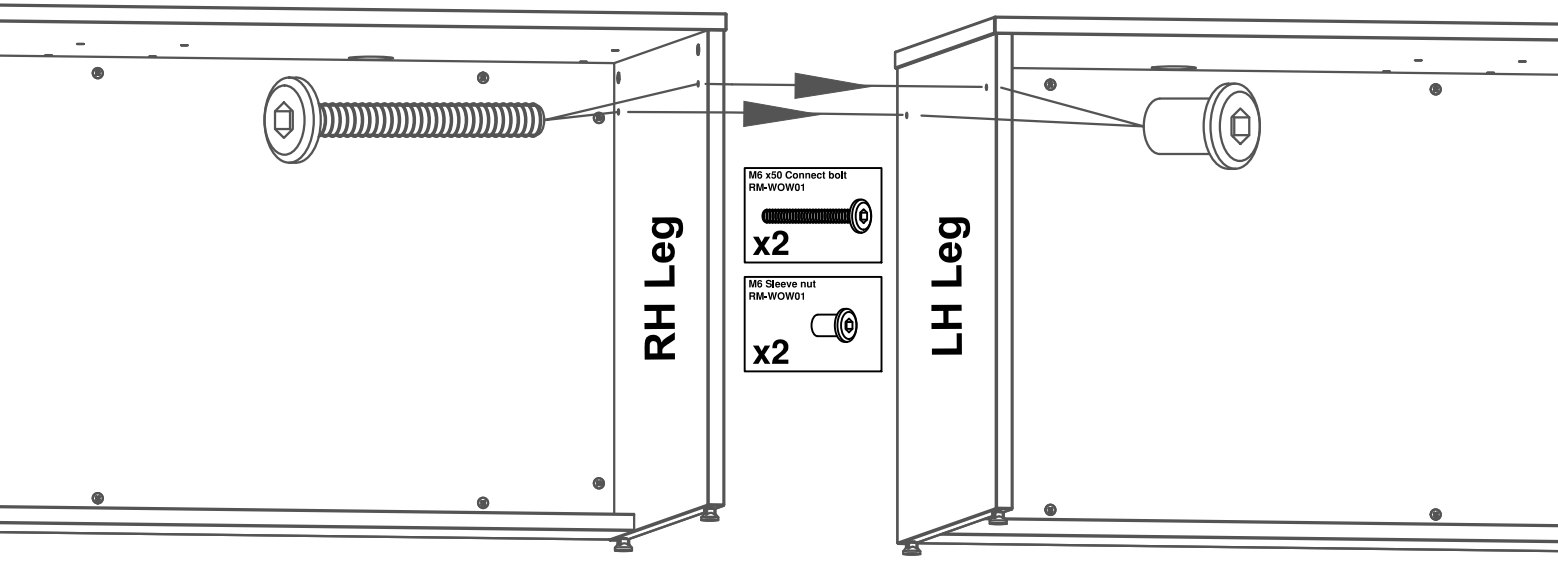

Linking desk to corner base unit

