

Otto - Poseur Tables & Benches

PTAOT1200 - PTAOT1800 - HB1050 - HB1650



ASSEMBLY INSTRUCTIONS

Otto
Poseur Tables & Benches

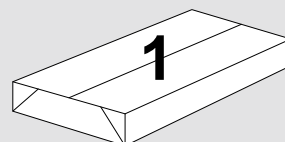

Pack 1:
1x Top

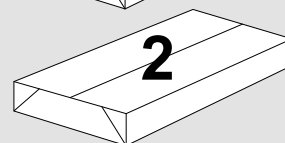

Pack 2:
1x Leg Pack & Fitting
Kit

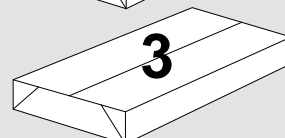

Pack 3:
2x Rail Pack

TOOLS REQUIRED
FOR ASSEMBLY

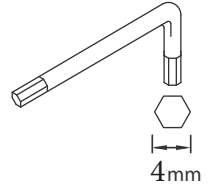
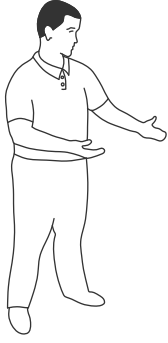

DONT STRUGGLE
2 MAN LIFT

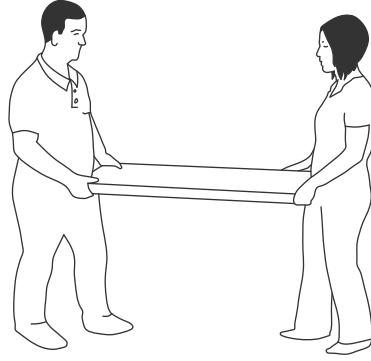
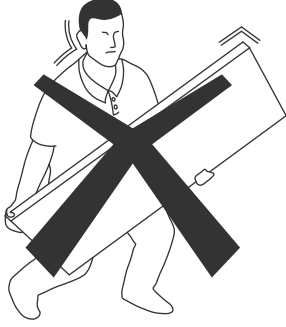

ALWAYS HANDLE
ITEMS WITH CARE

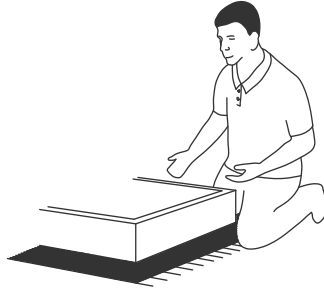
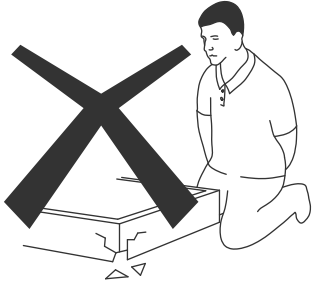

IF UNSURE CALL
FOR ASSISTANCE

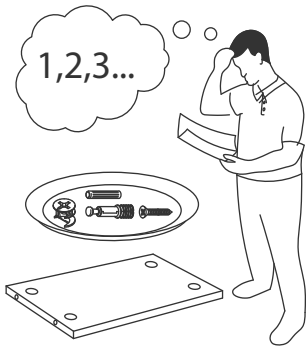

KEEP FITTINGS AWAY
FROM CHILDREN

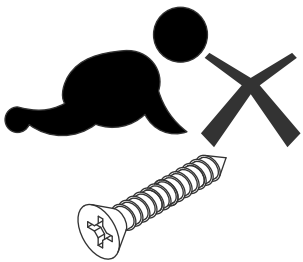



Please check that you have all the panels

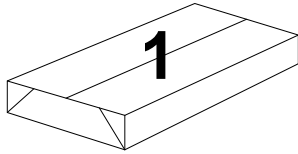

PACK 1:
1 x Top Panel

1200 x 700mm = PTAOT1200
1800 x 700mm = PTAOT1200
1050 x 350mm = HB1050
1650 x 350mm = HB1650

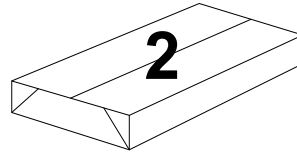
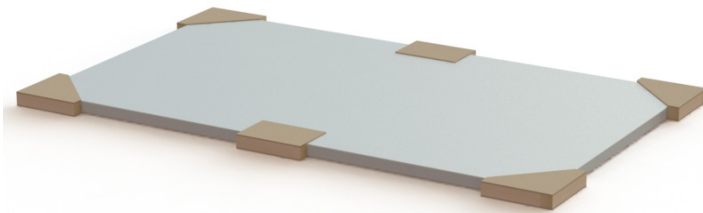

PACK 2:
1 x Leg Pack

350 x 745mm = OT-BLP
700 x 1180mm = OT-ELP

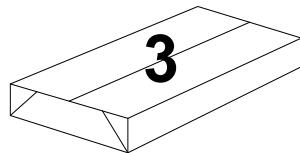

PACK 3:
2 x Rail Pack

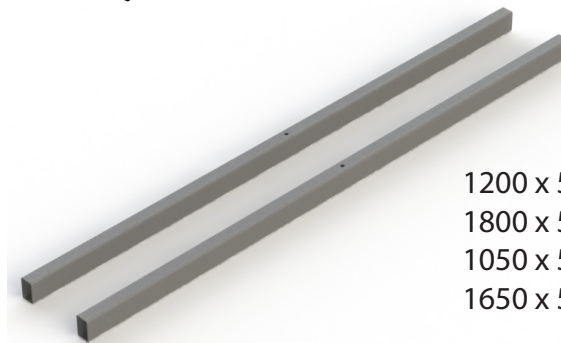

1200 x 50mm = RM-OT-CR12
1800 x 50mm = RM-OT-CR18
1050 x 50mm = RM-OT-CR10
1650 x 50mm = RM-OT-CR16



Please check that you have all the fittings

FITTINGS SUPPLIED



Connector Bolt - M6

Size 50mm PCS 6



Connector Bolt - M6

Size 20mm PCS 16



Screw-in Foot - M8

Size 48 Dia. x 10mm PCS 4

OTTO POSEUR TABLE & BENCH ASSEMBLY

1

Step 1

Unpack your new Otto poseur table / bench seating unit and please recycle all packaging.

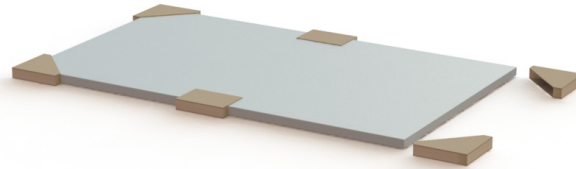

2

Step 2

Screw in the M8 adjustable foot into the leg frames as shown and turn clockwise to tighten.

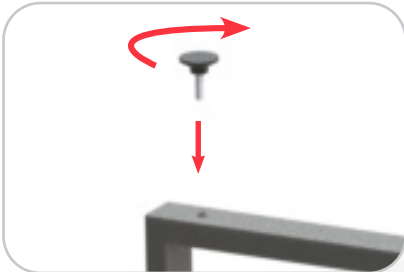

3

Step 3

Slide the cross rails into the spigots on the end leg and attach the M6 x 20mm bolt as shown.

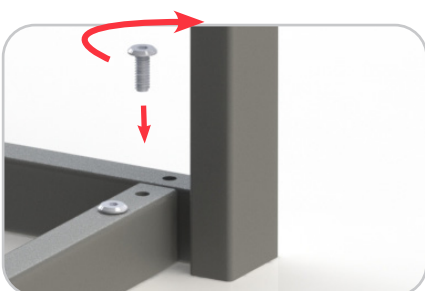

4

Step 4

Repeat by attaching the remaining end leg to the cross rails and attach the M6 x 20mm bolt as shown.

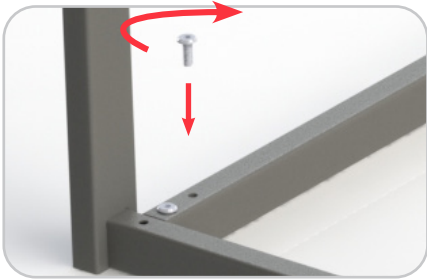

5

Step 5

Place the top panel face down and align the holes in the frame with the inserts in the top panel.

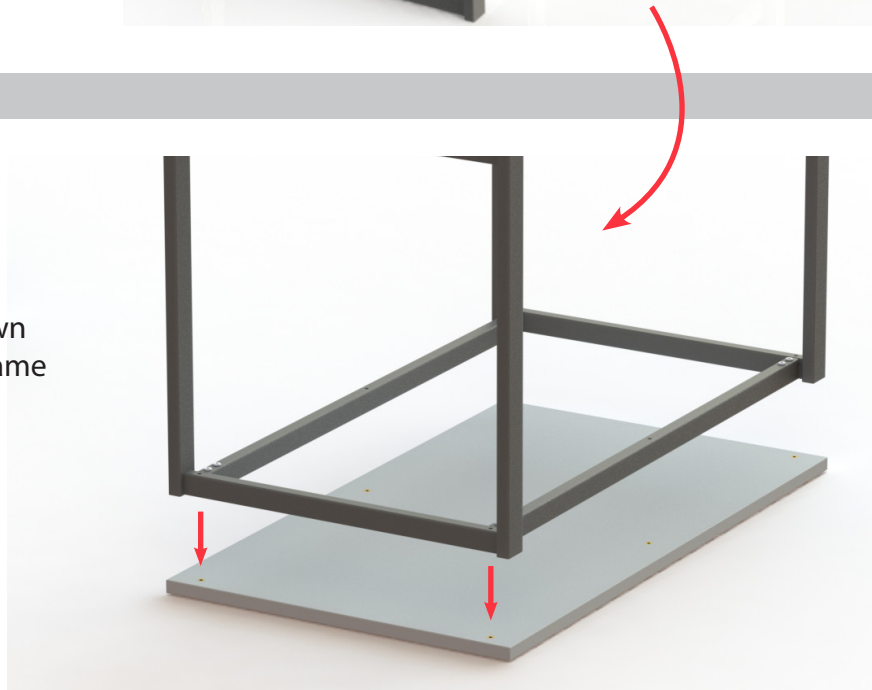

6

Step 6

Attach the M6 x 50mm bolts as shown to secure the frame to the top.

