

# Nera - Coffee Table

NERA-Q-TABLE - NERA-S-TABLE



## ASSEMBLY INSTRUCTIONS

Nera  
Coffee Table

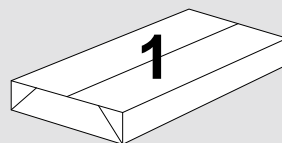

Pack 1:  
1x Top

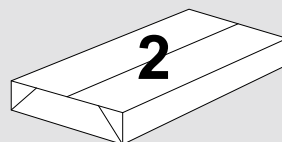

Pack 2:  
1x Frame

TOOLS REQUIRED  
FOR ASSEMBLY

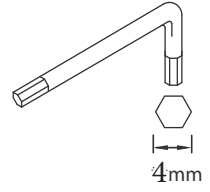
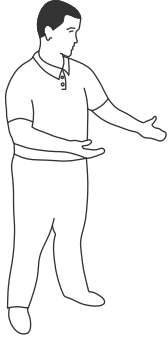

DONT STRUGGLE  
2 MAN LIFT

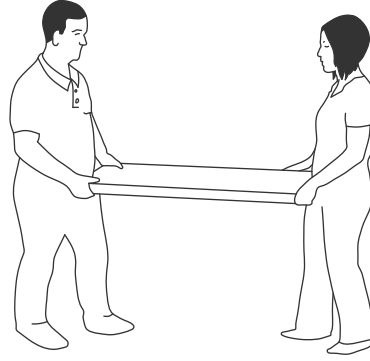
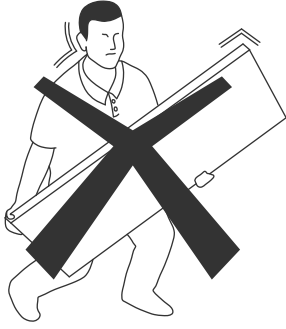

ALWAYS HANDLE  
ITEMS WITH CARE

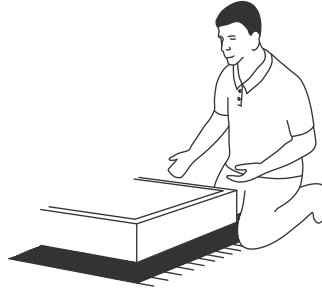
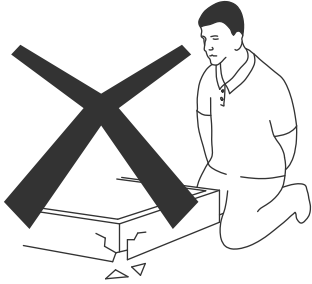

IF UNSURE CALL  
FOR ASSISTANCE

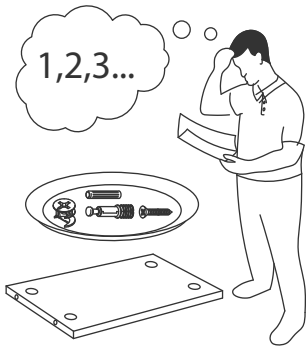

KEEP FITTINGS AWAY  
FROM CHILDREN

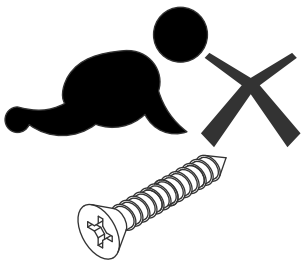



Please check that you have all the panels

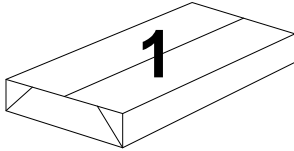

**PACK 1:**  
1 x Top

700 x 700mm = **NER-CT7Q-TOP383**  
700 x 700mm = **NER-CT7S-TOP429**

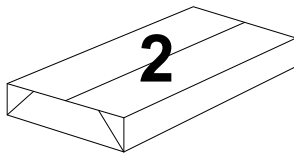
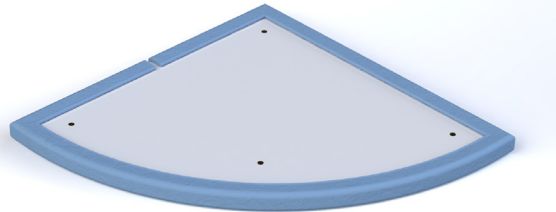

**PACK 2:**  
1 x Frame

700 x 700mm = **NE-M02Q-MLF**  
700 x 700mm = **NE-M02S-MLF**

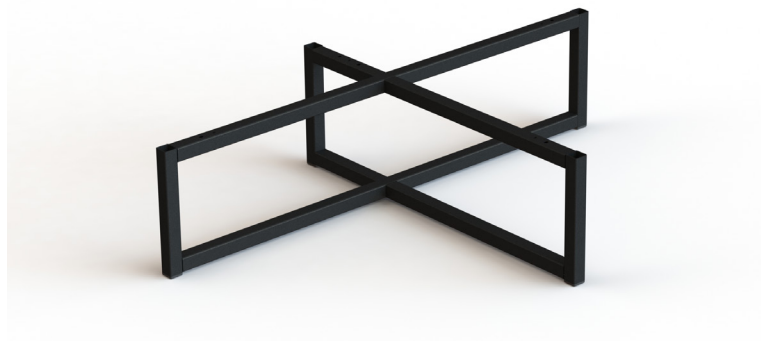

Please check that you have all the fittings

**FITTINGS SUPPLIED**



Connector Bolt

Size  
40mm

**PCS**  
**4**

# NERA COFFEE TABLE ASSEMBLY

1

## Step 1

Unpack your new Nera coffee table and please recycle all packaging.

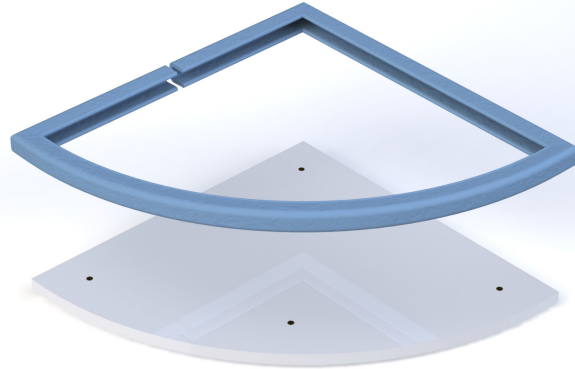

2

## Step 2

Align the frame with the fixing holes located on the underside of the top panel.

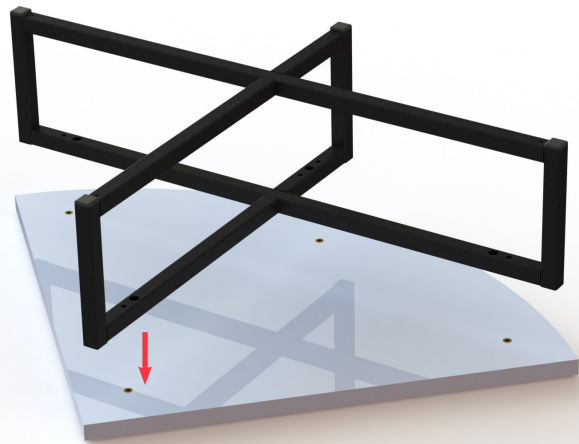
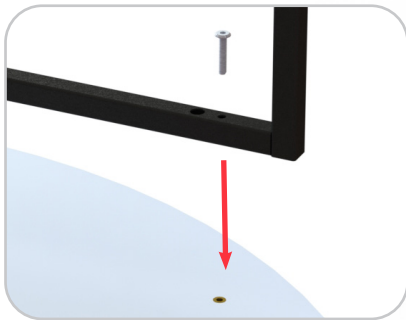

3

## Step 3

Using the M6 connector bolts fix the frame to the top turning clockwise

