

# Anson - Executive Desk

## AN-ED



### ASSEMBLY INSTRUCTIONS

Anson  
Executive Desk

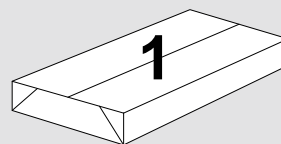

**Pack 1:**  
1x Top Pack

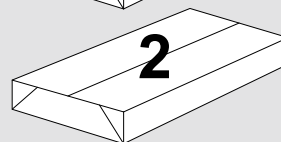

**Pack 2:**  
1x 1000d Leg  
Pack

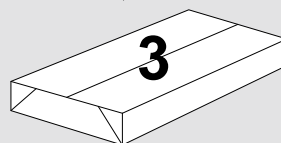

**Pack 3:**  
1x 800d Leg  
Pack

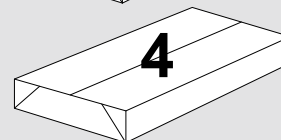

**Pack 4:**  
1x Modesty  
Panel Pack

TOOLS REQUIRED  
FOR ASSEMBLY

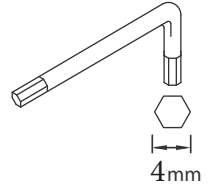
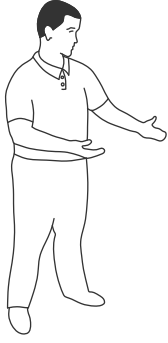

DONT STRUGGLE  
2 MAN LIFT

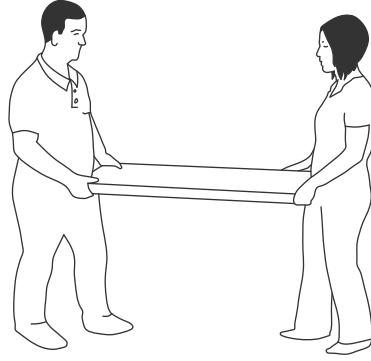
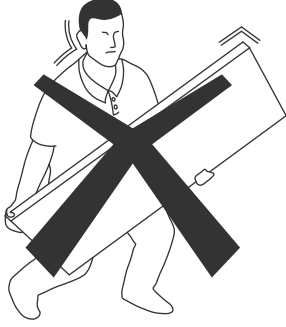

ALWAYS HANDLE  
ITEMS WITH CARE

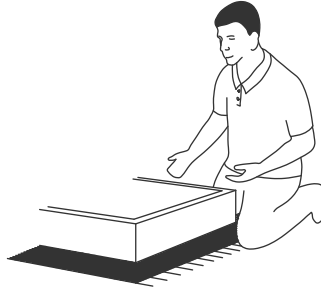
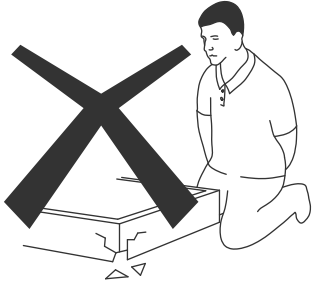

IF UNSURE CALL  
FOR ASSISTANCE

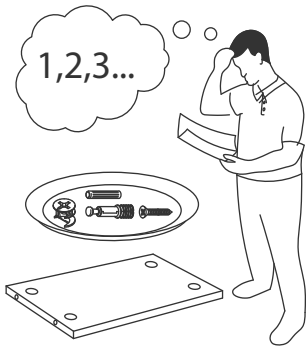

KEEP FITTINGS AWAY  
FROM CHILDREN

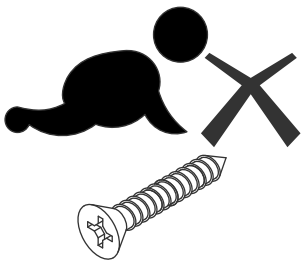



Please check that you have all the parts

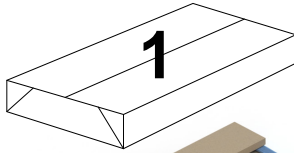

**PACK 1:**  
2 x Top Pack

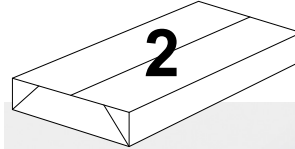
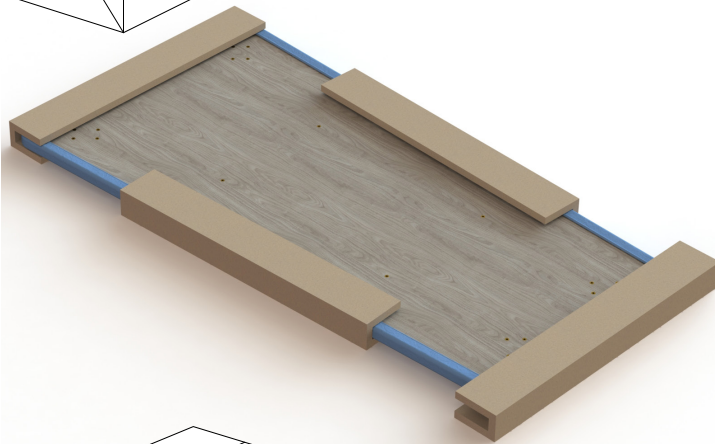

**PACK 2:**  
1 x 1000 Leg Pack

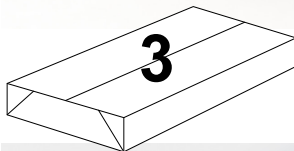
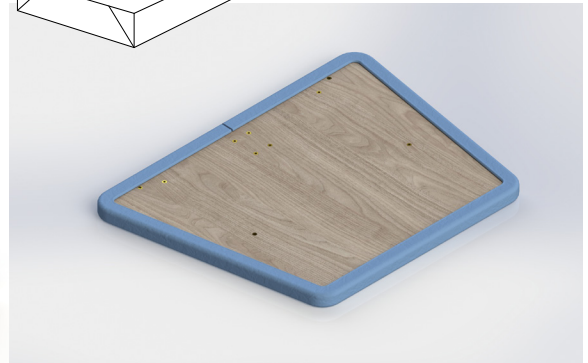

**PACK 3:**  
1 x 800 Leg Pack

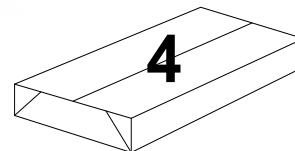
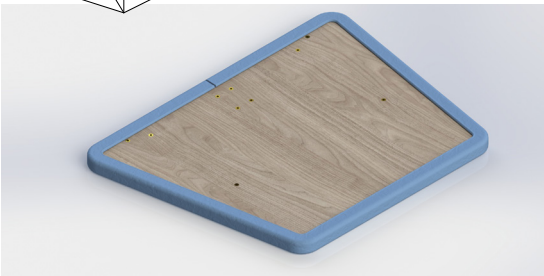

**PACK 4:**  
1 x Modesty Panel

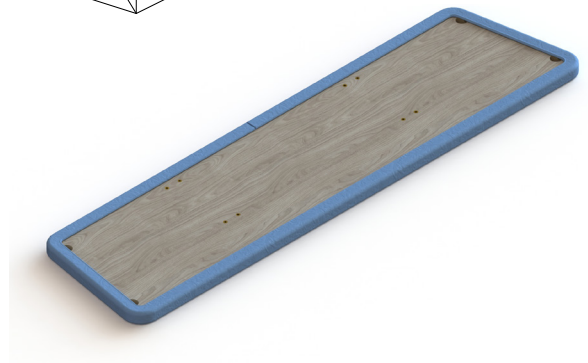

Please check that you have all the fittings

**FITTINGS SUPPLIED**



Connector Bolt - M6

Size 20mm **PCS 26**



CAM Fixture

Size 40mm **PCS 4**



Leg Fixing Bracket

Size 25 x 80mm **PCS 4**



Pin Fixture - M6

Size 8mm x 30mm **PCS 4**



Top Fixing Bracket

Size 200 x 200mm **PCS 2**

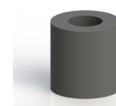

Spacer

Size 20 x 20mm **PCS 4**

# ANSON EXEC DESK ASSEMBLY

## 1

### Step 1

Unpack your new Anson executive desk and please recycle all packaging.

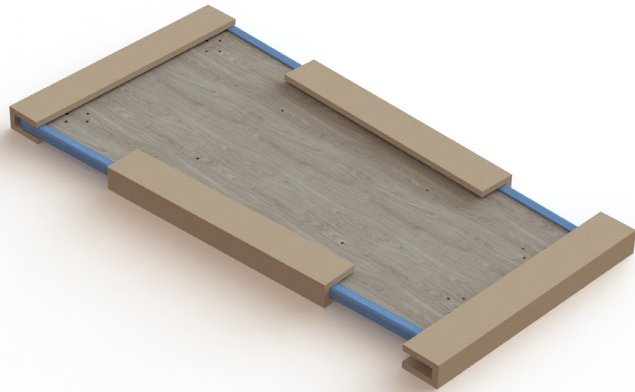

## 2

### Step 2

Locate and attach the pins as shown and tighten turning clockwise.



## 3

### Step 3

Locate the brackets to the fixing holes and attach using the M6 x 20mm bolts as shown.





# ANSON EXEC DESK ASSEMBLY

## 4

### Step 4

Locate the adjustable feet as shown turning clockwise to tighten (anti-clockwise to adjust).

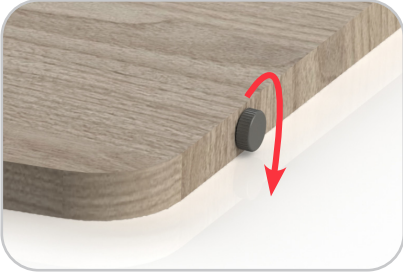

## 5

### Step 5

Insert the large cams into the modesty panel as shown.

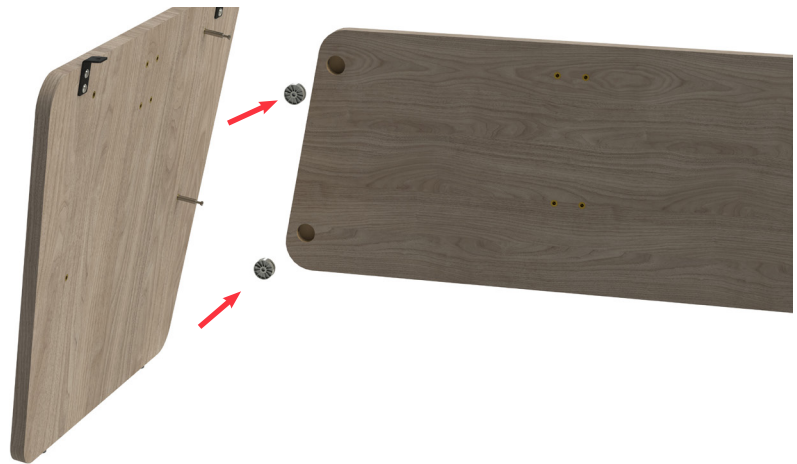

## 6

### Step 6

Slide the spacers over the pins on the leg panel as shown.

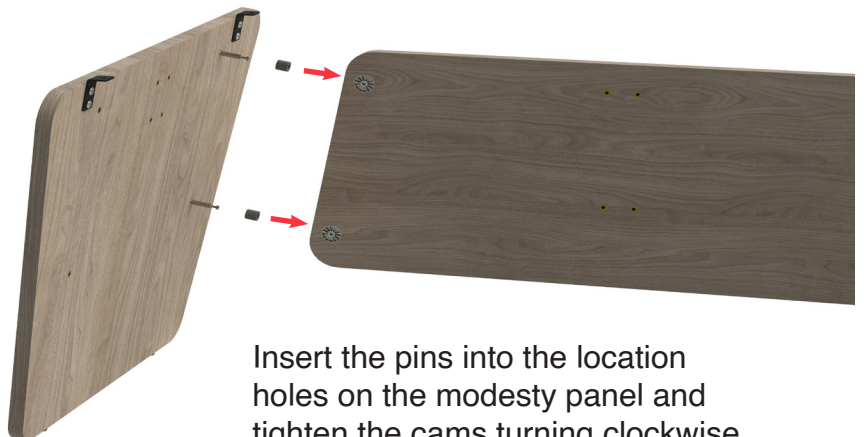

Insert the pins into the location holes on the modesty panel and tighten the cams turning clockwise.

# ANSON EXEC DESK ASSEMBLY

## 7

### Step 7

Repeat steps 2-6 for the opposite leg panel.



## 8

### Step 8

Locate and attach the leg rail aligning the holes located as shown using the M6 x 20mm bolts and tighten.



## 9

### Step 9

Locate the modesty panel support brackets to the fixing holes located on the rail and the modesty panel.

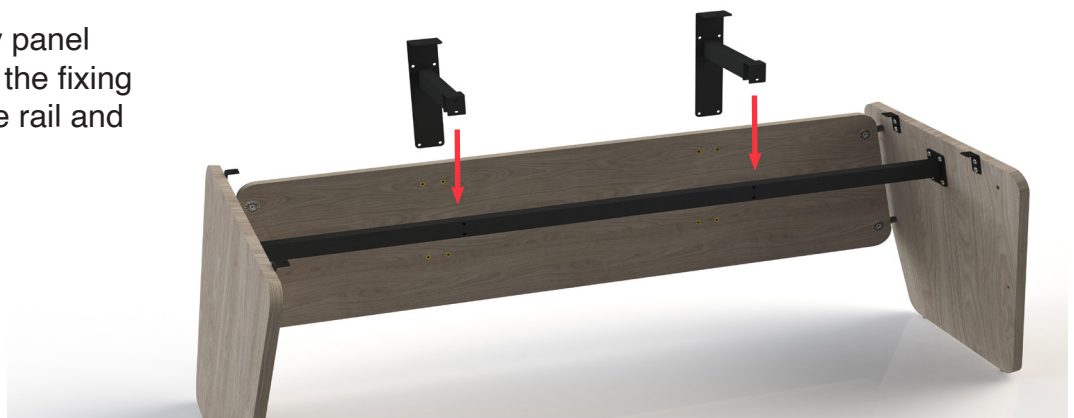

# ANSON EXEC DESK ASSEMBLY

## 10

### Step 10

Affix the brackets as shown using the M6 x 20mm bolts.

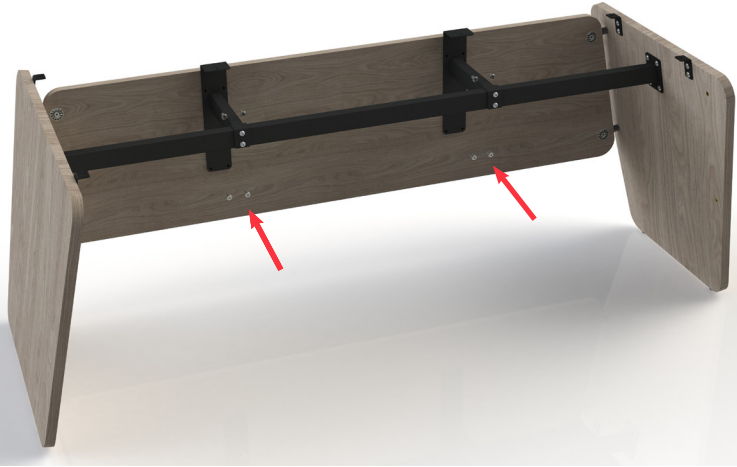

## 11

### Step 11

Locate and attach the top panel aligning the holes on the underside of the top to the fixing brackets on the legs and modesty panel.



## 12

### Step 12

Affix the brackets to the top panel using the M6 x 20mm bolts as shown.

