

Flux - Box Locker

FL-BLD1



ASSEMBLY INSTRUCTIONS

Flux
Box Locker

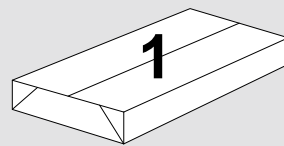

Pack 1:
1x Box Locker
FL-BLD1

TOOLS REQUIRED
FOR ASSEMBLY

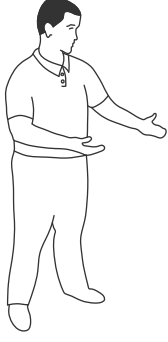

DONT STRUGGLE
2 MAN LIFT

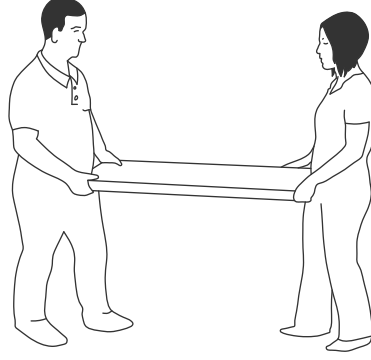
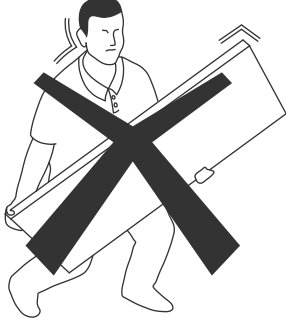

ALWAYS HANDLE
ITEMS WITH CARE

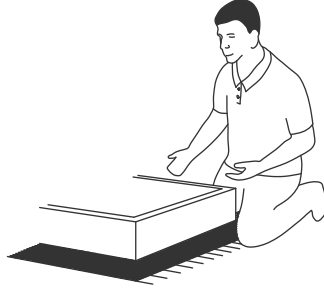
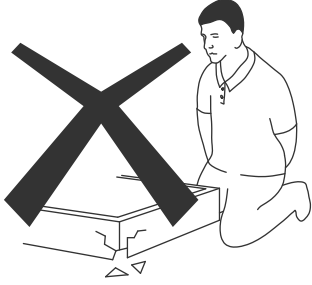

IF UNSURE CALL
FOR ASSISTANCE

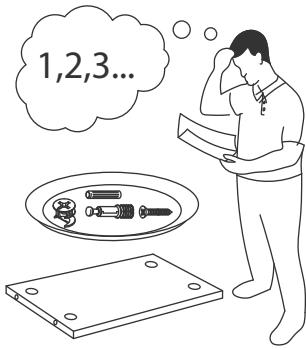

KEEP FITTINGS AWAY
FROM CHILDREN

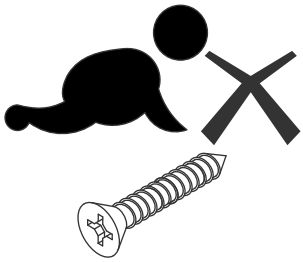



Please check that you have all the panels

FL-BLD1

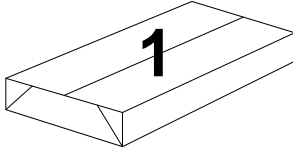

PACK 1:
1 x Box Locker

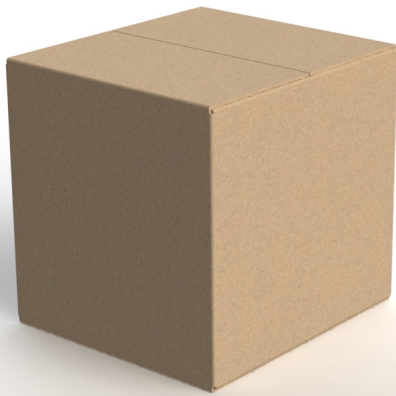

Please check that you have all the fittings

FITTINGS SUPPLIED



Screw-in Pin

Size
13mm

PCS
4

FLUX BOX LOCKER ASSEMBLY

1

Step 1

Unpack your new box locker unit and please recycle all packaging.

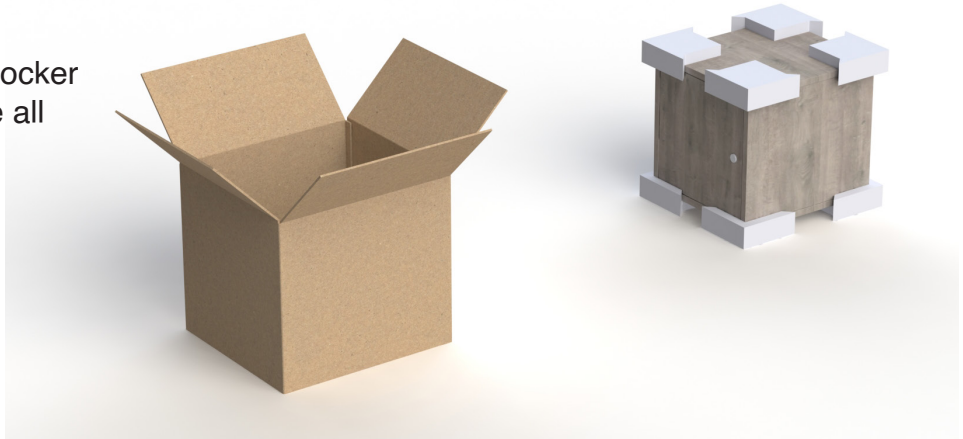

2

Step 2

Place the box locker in the desired location as shown.



3

Step 3

Once in place secure from the underside by screwing in the 4x M4 steel pins as shown.

