

How to set-up your Freedom wireless rechargeable keyboard

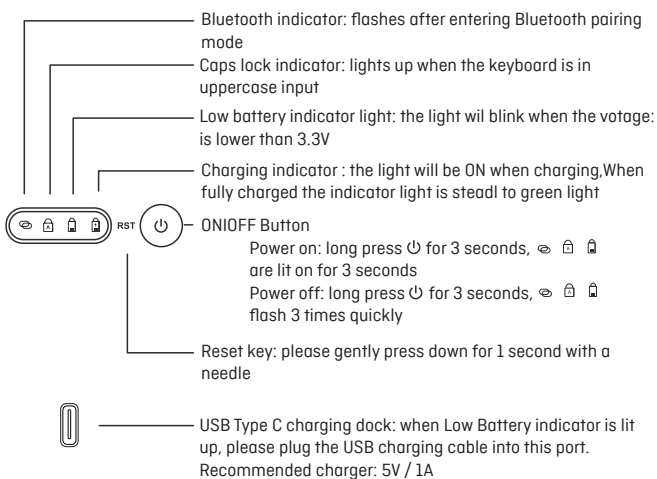

Getting Started Guide



Product Specifications

1. Standard bluetooth interface
2. Operating distance: 10 meters
3. Modulation system: GFSK
4. Working current: < 8mA (when the touchpad is working)
5. Standby current: < 0.3mA
6. Sleeping current: < 40uA
7. Charging current: 100mA
8. Standby time: > 100 days
9. Charging time: 2-3hours
10. Working time: > 30/100 hours (turn off the backlight)
11. Lithium battery Life: 3 years
12. Key strength: 80 10g
13. Key life: 5 million stroke
14. Operating temperature: -10°C - +55°C

How to Connect your Bluetooth keyboard

1. Press and hold the power button for 3 seconds, the Bluetooth indicator, CapsLock indicators, and weak current indicator will stay on for 3 seconds and then off. (Some models automatically enter pairing when they are turned on, if the current model does not enter, manually press **FN +** to enter the pairing)



2. Open and unlock your device and click on the "Settings" icon

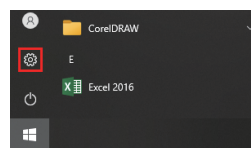

3. In the settings menu, click on the "devices" menu

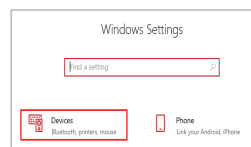

4. Select Bluetooth in the system, turn on Bluetooth on the right and click "Add Bluetooth or other device". Click the Bluetooth function to search for nearby Bluetooth devices

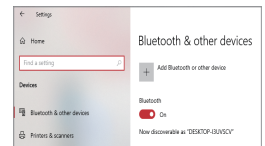

5. Discover the Bluetooth keyboard device: Bluetooth Keyboard, and click on it the device is automatically connected, and the Bluetooth indicator is off

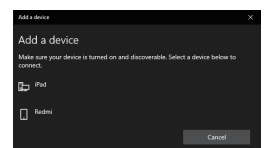

6. It can be used normally after closing the connecting page

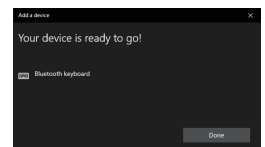

Attention

1. When not in use for a longer time, please turn off keyboard in order to prolong battery life.
2. In order to obtain a long battery life, always charge keyboard before low power indicator flashes. Always charge at least for 2 hours.

Energy saving sleep mode

When keyboard not use will be enter sleep mode after 15 minutes keyboard indicator will off, press any key 5s to wake it up when need use again then keyboard indicator will turn on.

Troubleshooting

1. Make sure the power is turned on
2. Ensure keyboard within operating distance
3. Make sure the battery has power
4. Ensure the device's Bluetooth was turned on
5. Ensure the wireless keyboard has connected with the Bluetooth
6. If the keyboard does not work after turning on the power switch, charge the keyboard's battery first and then reset the keyboard.

Cleaning



















Wipe the keys using alcohol or a similar decontaminating solution

Charging

When the power indicator is blinking, the battery is low and needs to be recharged.

1. Insert charging lead into the keyboard's USB port
2. Connect the other end of the cable to a power adapter or the tablet's USB port
3. The light indicating charging will light up and will stay so as long as the keyboard's battery is recharging. It will turn green when battery fully charged.

Keyboard Shortcut Function Description







	Mute		Volume -		Volume +
	Play/Pause		Previous track		Next track
	Search		Sharing		Wireless
	Set Up		Function Key		Touch Pad Switch
	Backlight Switch		Colors Conversion		Bluetooth pairing
	Select all		Input method switch		Screen capture

Note: This key is only available on the backlit version of the keyboard













 Color adjustment: direct click, a total of 7 color cycles

 Brightness adjustment: Fn combination button, a total of 3 brightness cycle

Touchpad Operation instructions

Touchpad Function	Mouse Function	Finger Schematic	Finger Movement
Move	Move the cursor		Swipe your finger
Quick click with one finger	Left mouse button		Click with one finger
Two-finger click	Right mouse button		Two-finger click
Quick double tap with one finger	Double-tap with one finger		Quick double tap with one finger
Quick double-click and drag with one finger	Left click to select the target and drag		Quick double-click and drag with one finger
Two fingers move vertically	Middle button vertical scroll		Two fingers move vertically
Two fingers move horizontally	Middle button horizontal scroll		Two fingers move horizontally

Touchpad Gestures

Gesture	Finger Schematic	Function Description
Enlarge		Enlarge goal similar to holding down Ctrl key and scroll mouse wheel
Narrow		Narrow target, similar to holding down Ctrl key and scroll mouse wheel
Three-fingers click		Win+S key combination (open Cortana)
Four-fingers click		Win+A key combination (open Action + Center)
Three-fingers left draw		Alt+ Shift + Tab key combination (active window switch)
Three-fingers right-zoned		Alt+Tab key combination (active window switch)
Three-fingers up plan		Win + Tab key combination (Open Task browser window)
Three-fingers draw down		Win + D key combination (show desktop)
From left edge to right plan		Win + Tab key combination (Open Task browser window)
From right to left draw edge		Win+A key combination (open Action + Center)
Draw down from top edge		Win+ J combination (narrow open window)
Draw upward from lower edge		Win+B key combination (show hide the taskbar)