

MANUAL

ENGLISH | NEDERLANDS | DEUTSCH | FRANÇAIS | ESPAÑOL | ITALIANO | PORTUGUÉS

50 / 70 UV COUNTERFEIT DETECTOR



PACKAGE CONTENTS

1. Safescan 50 or 70 counterfeit detector
2. Manual

THE DEVICE

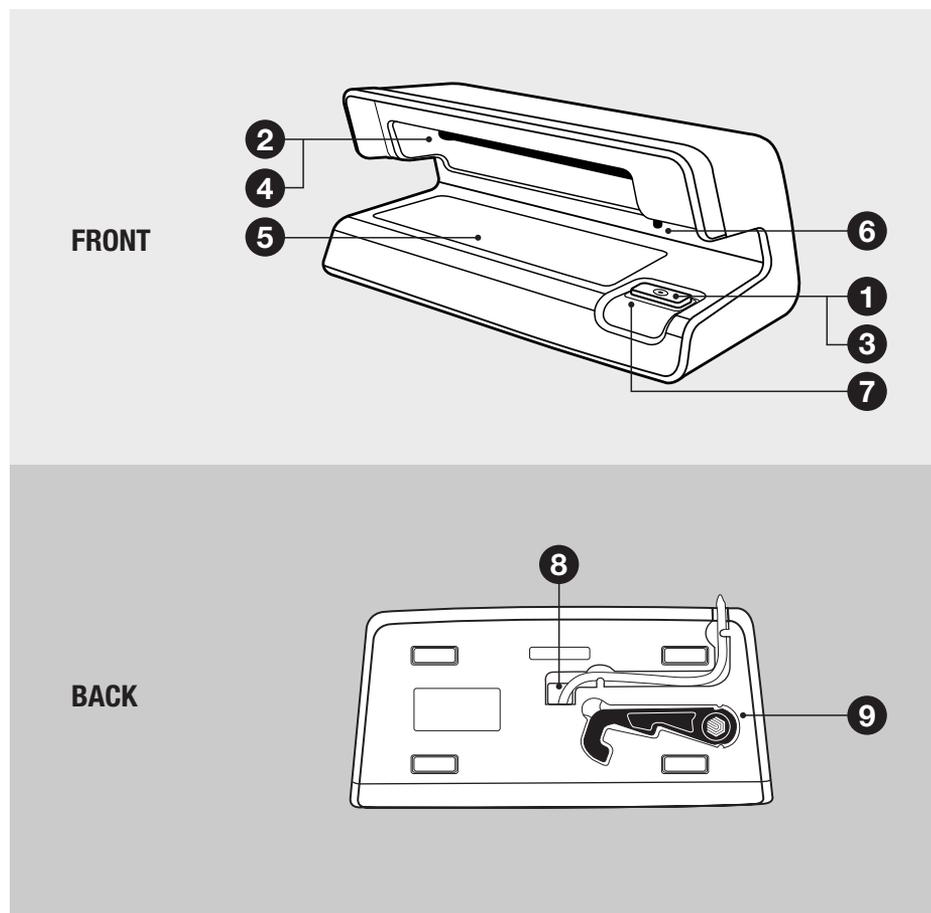

Safescan 50

1. On/Off button
2. Ultraviolet lamp (UV)

Safescan 70

3. Light switch (UV/WL) button
4. Ultraviolet lamp (UV)
5. White light (WL)
6. Motion sensor
7. Light guide

Safescan 50 & 70

8. Power cord outlet
9. UV-lamp removal tool

GETTING STARTED

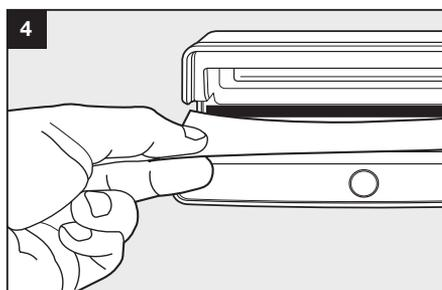
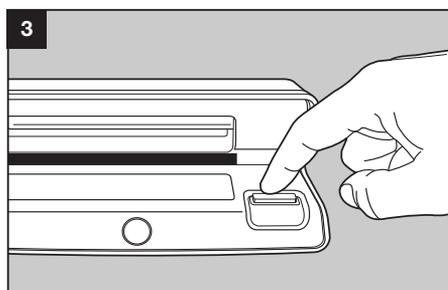
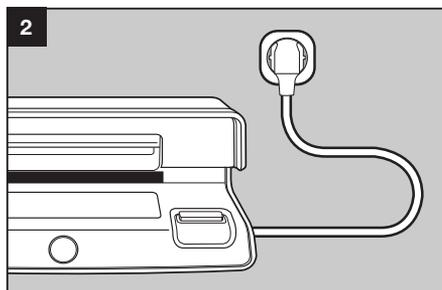
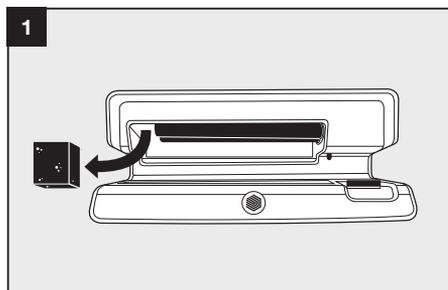

OPERATING INSTRUCTIONS

Safescan 50

Plug in and push the on/off switch for checking UV features on banknotes and ID's. Switch off after use.

Safescan 70

Plug in and push the light switch button once for UV light to check UV features on banknotes and ID's. Push the light switch button again for white light to check watermark, metal thread and micro print. After not using the Safescan 70 for 20 seconds in white light mode and 5 minutes in UV light mode, it will automatically go to standby.

To turn off the automatic standby function, press and hold the light switch button for 5 seconds, until the light guide goes out. After releasing the button it blinks twice. Repeat to reactivate the automatic standby function. To learn about safety features of banknotes and what to look for, please visit www.euro.ecb.int (euro), or your local national bank website (other currencies).

REPLACING THE UV-LAMP

1. Unplug the device from the power socket.
2. Hold it in your hand with the socket of the lamp facing upwards.
3. Take the UV lamp removal tool from the bottom of the device.
4. Place the hook between the 2 tubes and gently, but firmly pull the lamp from the socket.
5. Carefully remove the lamp from the device.
6. Turn the device with the lamp socket facing downwards.
7. Gently position the new lamp into the socket and press until it locks into place with a click.

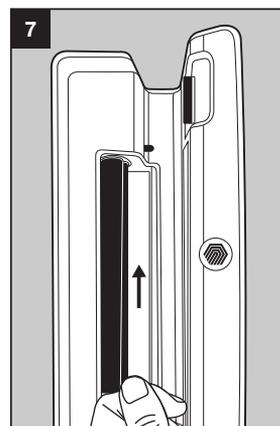
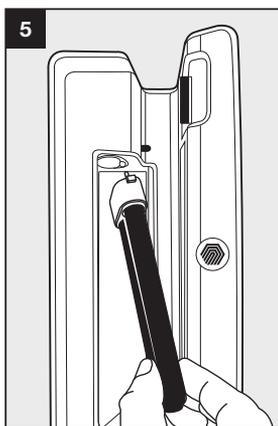
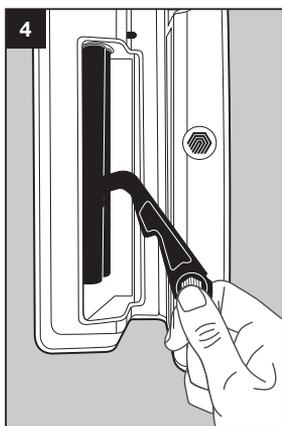

MAINTENANCE

- Clean with soft dry cloth only
- Do not use in a damp environment
- Remove plug from socket when cleaning or when not in use
- Do not use under strong light for optimal performance

SPECIFICATIONS

Dimensions (w x d x h)	: 206 x 102 x 88 mm, 8.1 x 4.0 x 3.5 inch
Ambient temperature	: 0° C - 40° C (32° F - 104° F)
Ambient humidity	: < 85%
Power source	: 220-240V / 50Hz 110V, 60Hz
Power consumption	: 11W max. (Safescan 50) / 16W max. (Safescan 70)

WARRANTY



This product is in compliance with the essential requirements and other relevant provisions of the applicable European directives. The Declaration of Conformity (DoC) is available via www.safescan.com.



If you want to dispose of the device, take it to a recycling centre. Never throw away electrical products with the household trash.

IN DE VERPAKKING

1. Safescan 50 of 70 valsgelddetector
2. Handleiding

HET APPARAAT

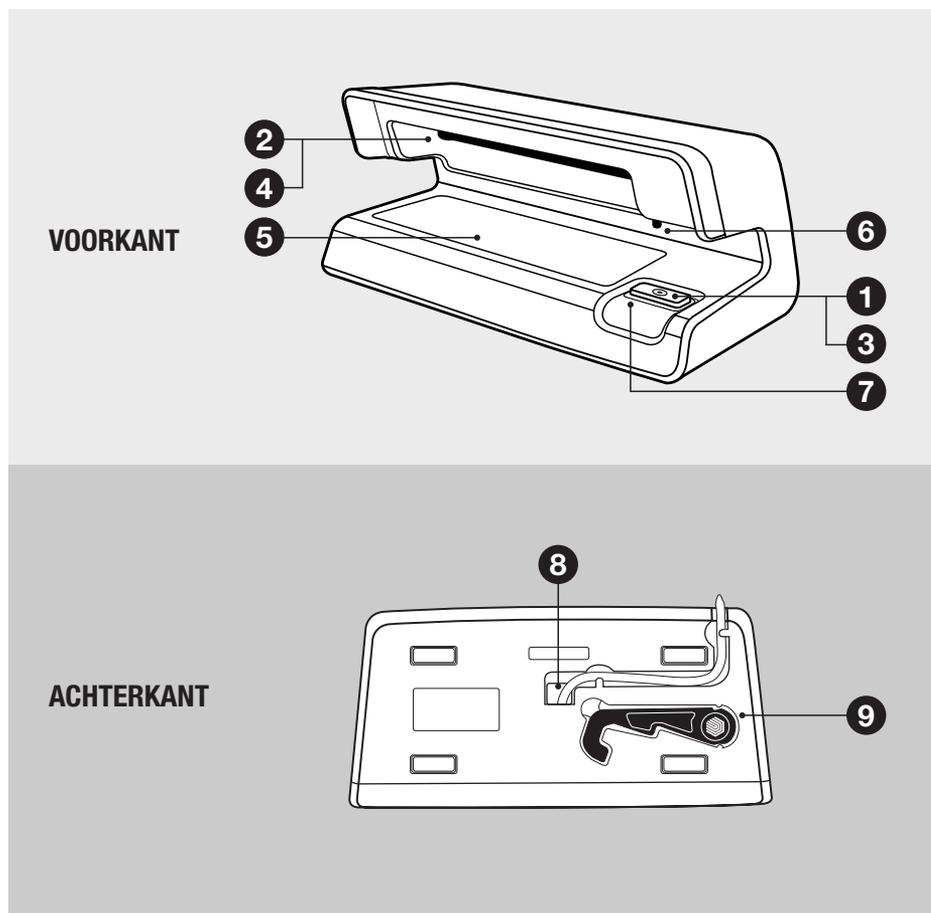

Safescan 50

1. Aan-uitknop
2. Ultraviolette lamp (UV)

Safescan 70

3. Lichtkeuzeknop (UV/WL)
4. Ultraviolette lamp (UV)
5. Wit licht (WL)
6. Bewegingsensor
7. Signaallampje

Safescan 50 & 70

8. Aansluiting stroomkabel
9. Haakje om de UV-lamp te verwijderen

AAN DE SLAG

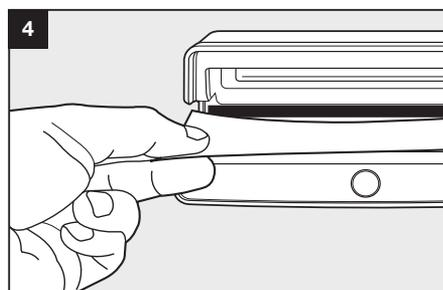
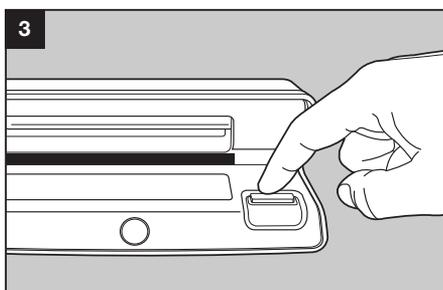
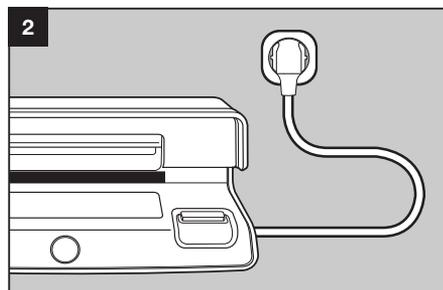
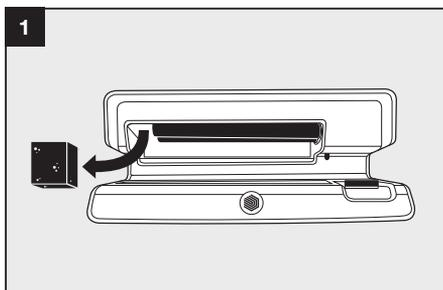

BEDIENING

Safescan 50

Steek de stekker in een stopcontact en druk op de aan-uitknop om bankbiljetten, identiteitsbewijzen of kredietkaarten op UV-kenmerken te controleren. Schakel uit na gebruik.

Safescan 70

Steek de stekker in een stopcontact en druk één maal op de lichtkeuzeknop om bankbiljetten, identiteitsbewijzen of kredietkaarten op UV-kenmerken te controleren. Druk nogmaals op de lichtkeuzeknop voor wit licht om het watermerk, de metaaldraad en de microprint te controleren. In wit licht modus schakelt de Safescan 70 na 20 seconden automatisch over naar stand-by. In UV licht modus duurt dit 5 minuten.

Om de automatische stand-by functie uit te schakelen, druk de lichtkeuzeknop 5 seconde in tot het signaallampje uitgaat. Na het loslaten van de knop knippert het signaallampje 2 maal. Herhaal om de automatische stand-by functie weer in te schakelen. Om de veiligheidskenmerken van euro bankbiljetten te leren herkennen, bezoek de ECB website: www.euro.ecb.int. Voor overige valuta controleert u de website van de betreffende lokale nationale bank.

DE UV-LAMP VERVANGEN

1. Haal de stekker van het toestel uit het stopcontact.
2. Neem het haakje om de lamp te verwijderen uit de onderkant van het toestel.
3. Hou het toestel in een hand omhoog met de fitting van de UV lamp aan de bovenzijde.
4. Plaats de haakje tussen de 2 lichtbuizen en trek stevig, maar voorzichtig de lamp uit de fitting.
5. Verwijder de UV-lamp uit het toestel.
6. Draai het toestel om met de fitting van de UV lamp aan de onderzijde.
7. Plaats de nieuwe UV-lamp voorzichtig in de fitting en druk aan tot de lamp in de fitting klikt.

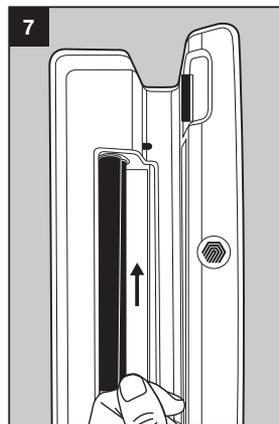
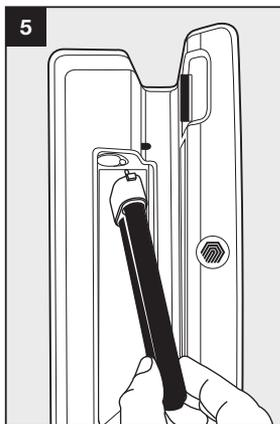
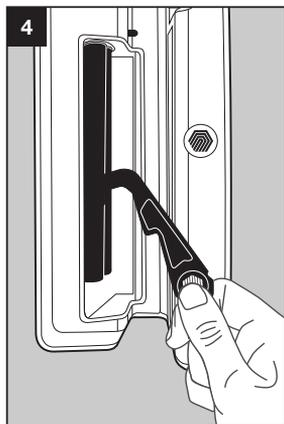

ONDERHOUD

- Alleen met een zachte droge doek schoonmaken
- Gebruik het toestel niet in een vochtige omgeving
- Haal de stekker uit het stopcontact als u het toestel reinigt of voor langere tijd niet gebruikt
- Gebruik het toestel bij voorkeur niet onder sterk licht voor optimale UV detectie

SPECIFICATIES

Afmetingen (lengte x breedte x hoogte)	: 206 x 102 x 88 mm
Omgevingstemperatuur	: 0° C - 40° C (32° F - 104° F)
Omgevingsvochtigheid	: < 85%
Voeding	: 220-240V / 50Hz
Energieverbruik	: max. 11 W (Safescan 50) / max. 16 W (Safescan 70)

GARANTIE



Dit product voldoet aan de essentiële eisen en andere relevante bepalingen van de Europese richtlijnen die op dit product van toepassing zijn. De Conformiteitsverklaring is beschikbaar op www.safescan.com.



Breng het toestel, indien mogelijk, na gebruik naar een recyclingepark. Dit product mag niet bij het normale huisvuil worden weggegooid.

IM KARTON

1. Safescan-Geldscheinprüfer der Serie 50 oder 70
2. Bedienungsanleitung

DAS GERÄT

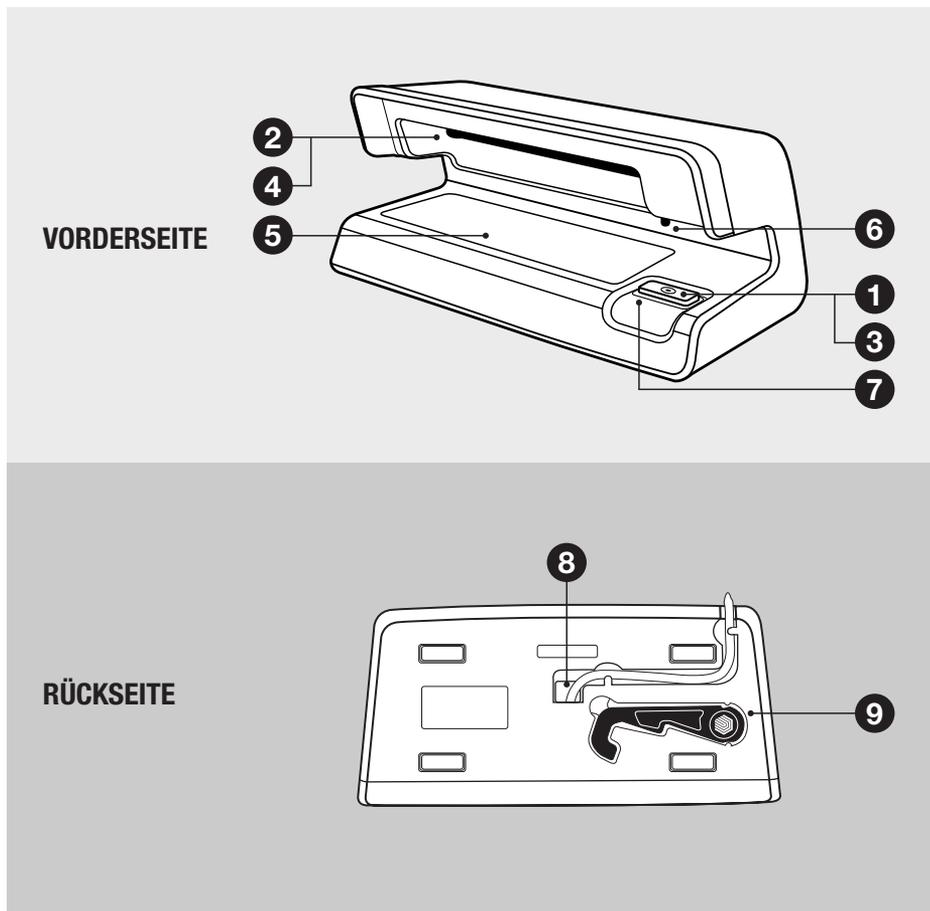

Safescan 50

1. Ein/Aus-Schalter
2. UV-Lampe (UV)

Safescan 70

3. Wechselschaltern (UV / WL)
4. UV-Lampe (UV)
5. Weisslicht (WL)
6. Bewegungssensor
7. Standby-Anzeige

Safescan 50 & 70

8. Netzkabelanschluss
9. Werkzeug zum Entfernen der UV-Lampe

ERSTE SCHRITTE

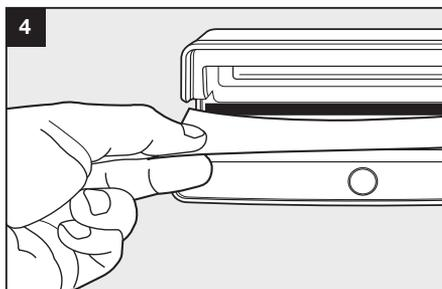
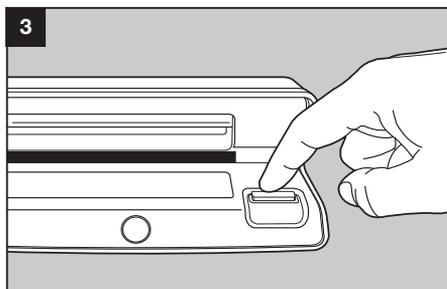
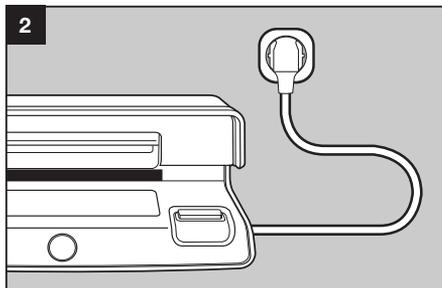
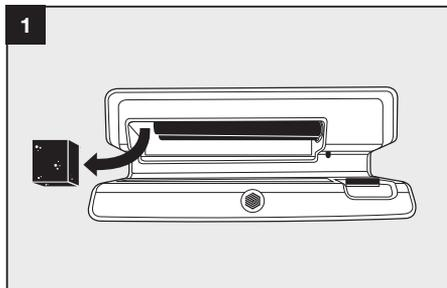

GEBRAUCHSANWEISUNG

Safescan 50

Schliessen Sie den Netzstecker an. Drücken Sie die Ein/Aus-Schalter für die Überprüfung der UV-Merkmale auf Banknoten, Ausweispapieren oder Kreditkarten. Schalten Sie das Gerät nach Gebrauch aus.

Safescan 70

Schliessen Sie den Netzstecker an. Und drücken Sie den Wechselschalter einmal für das Überprüfen der UV-Merkmale auf Banknoten, Ausweispapieren oder Kreditkarten. Drücken Sie den Wechselschalter zweimal für die Weisslichtüberprüfung. Prüfen Sie hiermit Wasserzeichen, Metalldraht und Mikrodruck.

Safescan 70 schalten bei nicht Gebrauch nach 20 Sekunden im Weisslicht-Modus und 5 Minuten im UV-Modus automatisch auf Standby. Um die automatische Standby-Funktion zu deaktivieren, drücken und halten Sie den Wechselschalter während 5 Sekunden bis die Standby-Anzeige ausschaltet. Nach dem loslassen des Schalters blinkt die Standby-Anzeige zweimal. Wiederholen Sie diesen Vorgang um die automatische Standby-Funktion zu aktivieren. Informationen zu Sicherheitsmerkmalen von Banknoten und worauf zu achten ist erhalten Sie auf der Webseite der Europäischen Zentralbank www.ecb.europa.eu (für Euro) oder der Webseite ihrer lokalen Nationalbank (andere Währungen).

AUSTAUSCHEN DER UV-LAMPE

1. Ziehen Sie den Stecker des Gerätes aus der Steckdose.
2. Halten Sie das Gerät mit dem Lampensockel nach oben in der Hand.
3. Entnehmen Sie das Werkzeug zum Entfernen der UV-Lampe an der Unterseite des Gerätes.
4. Platzieren Sie den Haken zwischen den zwei Röhren der UV-Lampe und ziehen Sie die Lampe behutsam und doch kräftig aus dem Lampensockel.
5. Entfernen Sie die Lampe vorsichtig.
6. Drehen Sie das Gerät und halten Sie es mit dem Lampensockel nach unten in der Hand.
7. Positionieren Sie die neue Lampe in den Lampensockel und drücken Sie vorsichtig bis die Lampe mit einem Klicken einrastet.

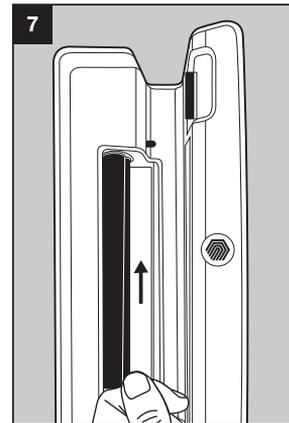
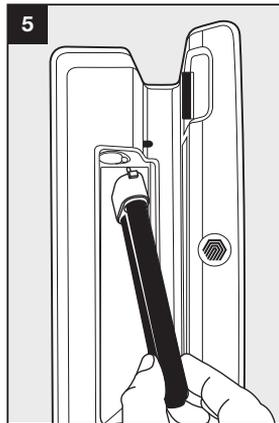
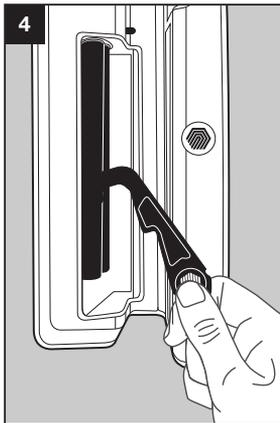

WARTUNG

- Reinigen Sie das Gerät mit einem weichen und trockenen Tuch
- Verwenden Sie das Gerät nicht in einer feuchten Umgebung
- Ziehen Sie den Stecker aus der Steckdose bevor Sie das Gerät reinigen oder wenn Sie das Gerät über einen längeren Zeitraum nicht benutzen
- Für eine optimale Leistung des Gerätes verwenden Sie es nicht in der Nähe von starken Lichtquellen

DEUTSCH

PRODUKTEIGENSCHAFTEN

Abmessungen (B x T x H)	: 206 x 102 x 88 mm
Umgebungstemperatur	: 0 °C - 40 °C (32 °F - 104 °F)
Umgebungsfeuchtigkeit	: < 85%
Stromquelle	: 220-240V / 50Hz
Stromverbrauch	: 11W max. (Safescan 50) / 16W max. (Safescan 70)

GARANTIE



Dieses Produkt entspricht den grundlegenden Anforderungen und weiteren einschlägigen Bestimmungen der anwendbaren europäischen Richtlinien. Die Konformitätserklärung (DoC) finden Sie auf: www.safescan.com.



Bringen Sie das Gerät zur Entsorgung nach Möglichkeit in ein Recyclingzentrum. Entsorgen Sie es nicht im normalen Hausmüll.

LA BOÎTE CONTIENT

1. Détecteur de faux-billets Safescan 50 ou 70
2. Manuel

PRODUIT

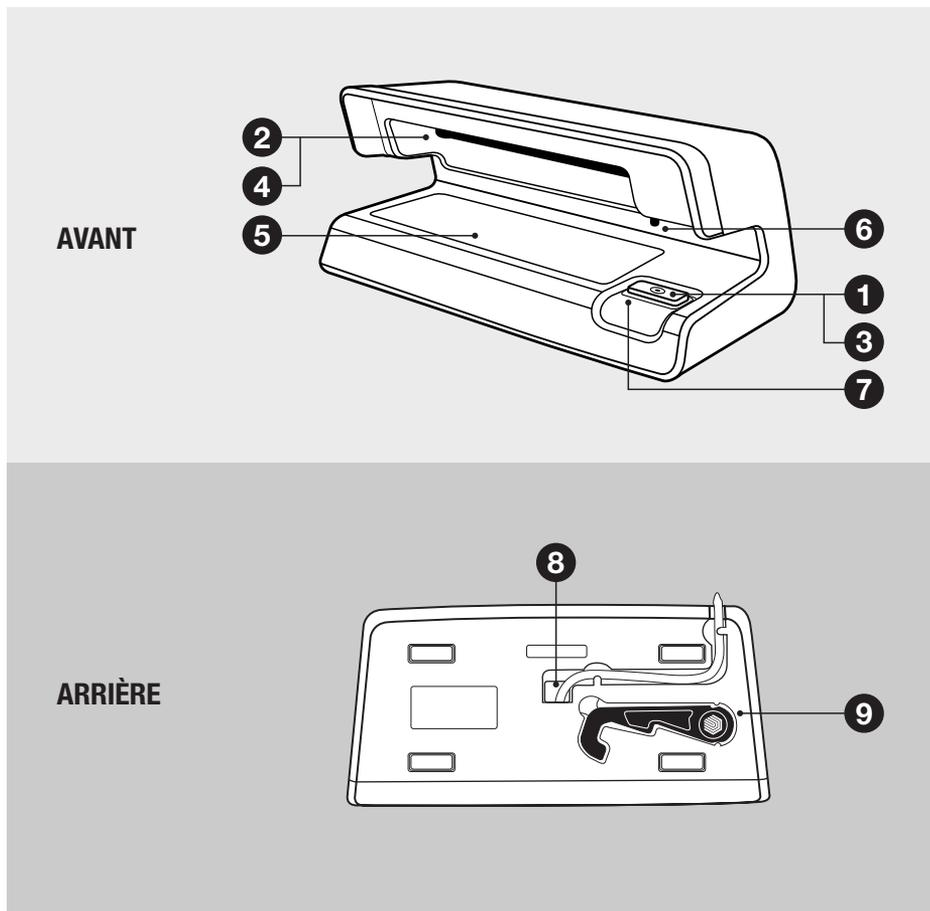

Safescan 50

1. Bouton marche/arrêt
2. Lampe à rayons UV

Safescan 70

3. Interrupteur de lumière (UV/WL)
4. Lampe à rayons UV
5. Lumière blanche (WL)
6. Capteur de mouvement
7. Témoin lumineux

Safescan 50 & 70

8. Prise d'alimentation
9. Outil de retrait de la lampe UV

GUIDE DE DÉMARRAGE

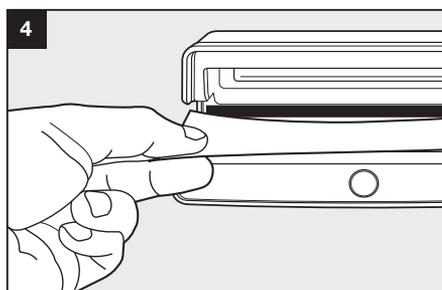
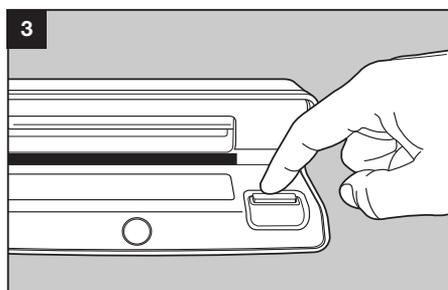
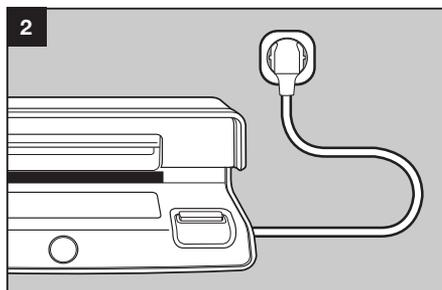
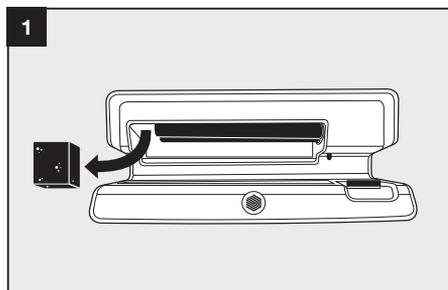

CONDITIONS D'UTILISATION

Safescan 50

Branchez l'appareil et appuyez sur le bouton marche/arrêt pour vérifier les caractéristiques UV des billets de banque et des cartes d'identité. Veuillez à éteindre l'appareil après utilisation.

Safescan 70

Branchez l'appareil et appuyez une fois sur le bouton d'allumage de la lampe pour vérifier les caractéristiques UV des billets de banque et des cartes d'identité. Appuyez à nouveau sur le bouton d'allumage de la lampe pour que la lumière blanche vérifie les filigranes, les bandes métalliques et les micro impressions. Le Safescan 70 qui reste inactif pendant au moins 20 secondes en mode lumière blanche et 5 minutes en mode lampe UV se mettra automatiquement en veille.

Pour désactiver la fonction de veille automatique, appuyez sur le bouton d'allumage de la lampe pendant 5 secondes jusqu'à ce que le guide de lumière sorte. Après avoir relâché le bouton, il clignote deux fois. Veuillez recommencer pour réactiver la fonction de veille automatique. Pour en savoir plus sur les conditions de sécurité des billets de banque et connaître les paramètres à vérifier, veuillez visiter le site Internet www.euro.ecb.int (concernant l'Euro) ou celui de votre banque nationale (pour les autres devises).

REEMPLACER LA LAMPE UV

1. Débranchez l'appareil de la prise de courant.
2. Tenez-le dans votre main avec la douille de la lampe tournée vers le haut.
3. Munissez-vous de l'outil de retrait de la lampe UV qui se trouve sous l'appareil.
4. Placez le crochet entre les 2 tubes et tirez doucement, mais fermement l'ampoule de la douille.
5. Retirez soigneusement l'ampoule de l'appareil.
6. Tournez l'appareil en tournant la douille vers le bas.
7. Mettez en place la nouvelle ampoule dans la douille et appuyez jusqu'au clic de mise en place.

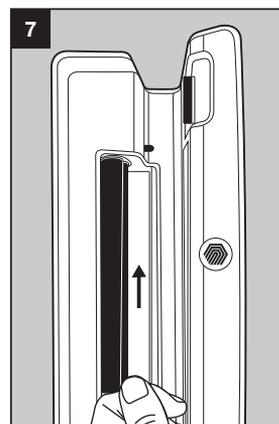
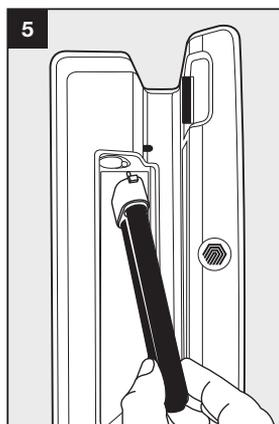
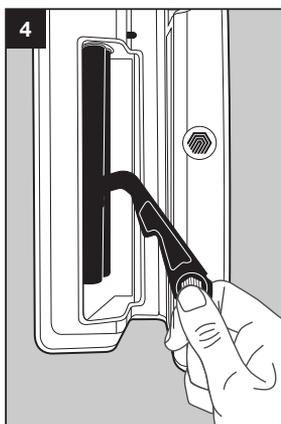

MAINTENANCE

- Nettoyer à l'aide d'un chiffon doux et sec uniquement
- Ne pas utiliser dans un environnement humide
- Retirer la fiche de la prise pour le nettoyage et chaque fois que l'appareil n'est pas utilisé
- Ne pas exposer à une lumière forte pour des résultats optimaux

CARACTÉRISTIQUES

Dimensions (L x P x H)	: 206 x 102 x 88 mm
Température ambiante	: 0° C - 40° C (32° F - 104° F)
Humidité ambiante	: < 85%
Alimentation	: 220-240V / 50Hz
Consommation	: 11W max. (Safescan 50) / 16W max. (Safescan 70)

GARANTIE



Ce produit est conforme aux exigences essentielles et aux dispositions importantes des directives européennes applicables. La déclaration de conformité (DoC) est disponible sur www.safescan.com.



Dans la mesure du possible, il faut rapporter l'appareil au centre de recyclage après utilisation. Ne pas jeter le produit avec les déchets courants.

CONTENIDO DE LA CAJA

1. Detector de falsificaciones Safescan 50 o 70
2. Manual

PRODUCTO

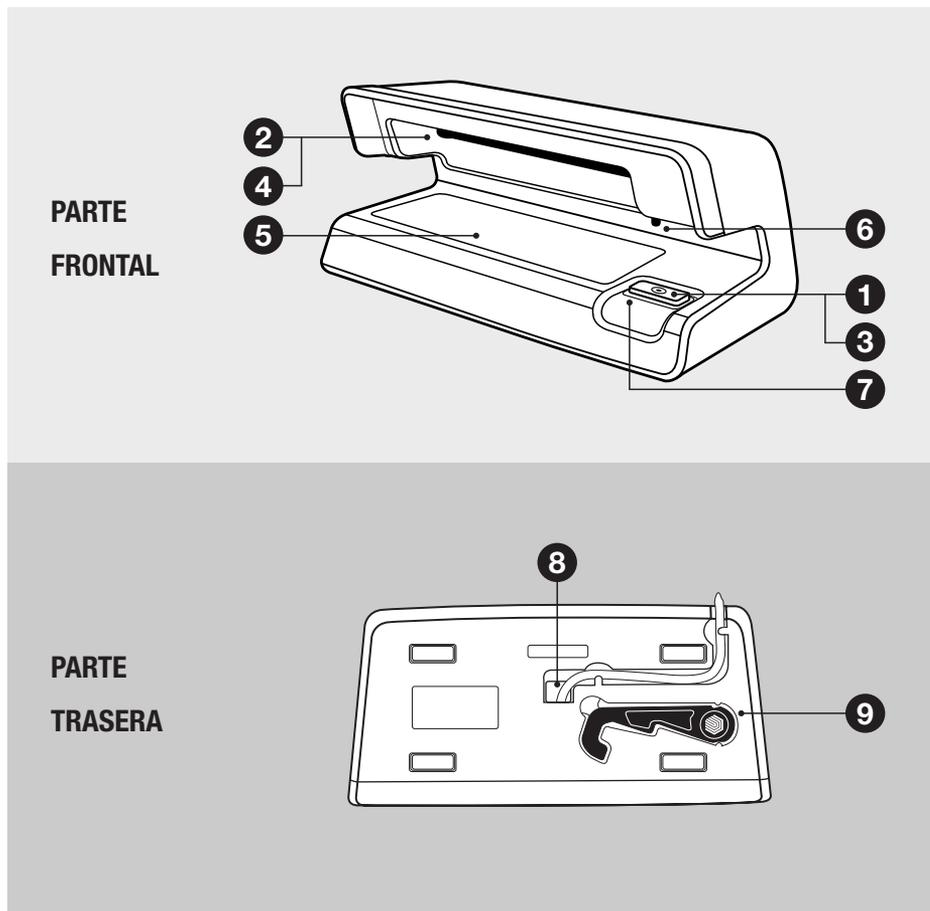

Safescan 50

1. Botón on/off
2. Lámpara ultravioleta (UV)

Safescan 70

3. Botón de conmutación de la luz (UV/WL)
4. Lámpara ultravioleta (UV)
5. Luz blanca (WL)
6. Sensor de movimiento
7. Guía de luz

Safescan 50 & 70

8. Toma de cable de corriente
9. Herramienta para retirar la lámpara UV

INTRODUCCIÓN

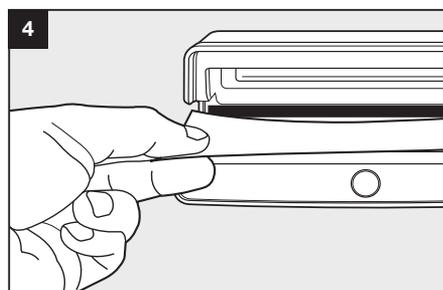
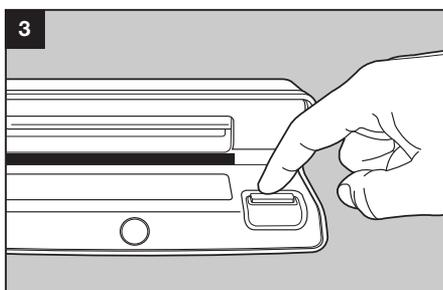
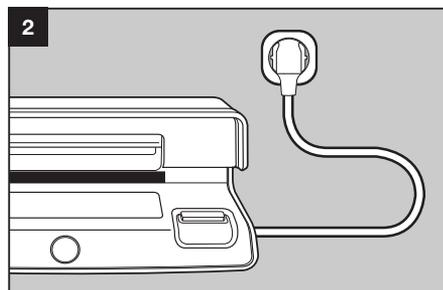
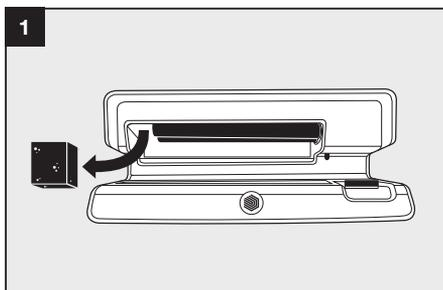

DIRECCIONES DE USO

Safescan 50

Enchufe y pulse el interruptor on/off para comprobar las características de UV en billetes y documentos de identidad. Apague después del uso.

Safescan 70

Enchufe y pulse el interruptor on/off una vez para que la luz UV compruebe las características UV en billetes y documentos de identidad. Pulse el botón de conmutación de luz otra vez para que la luz blanca compruebe la marca de agua, hilo metálico y microimpresión. Si el Safescan 70 está 20 segundos sin ser utilizado en modo de luz blanca y 5 minutos en el modo de luz UV, pasará inmediatamente a standby.

Para apagar la función standby automática, presione y mantenga pulsado el botón de conmutación de luz durante 5 segundos hasta que la guía de luz se apague. Tras soltar el botón, parpadeará dos veces. Repita para reactivar la función automática de standby. Para más información sobre las características de seguridad de los billetes y a qué prestar atención, visite www.euro.ecb.int (euros) o el sitio web de su banco nacional local (otras divisas).

SUSTITUIR LA LÁMPARA UV

1. Desenchufe el dispositivo de la toma de corriente.
2. Sosténgalo en la mano con el enchufe de la lámpara mirando hacia arriba.
3. Retire la herramienta de retirada de la lámpara UV de la parte inferior del dispositivo.
4. Coloque el gancho entre los 2 tubos y, suave pero firmemente, suelte la lámpara del enchufe.
5. Retire cuidadosamente la lámpara del dispositivo.
6. Gire el dispositivo con el enchufe de la lámpara mirando hacia arriba.
7. Posicione con cuidado la nueva lámpara en el enchufe y presione hasta que se ajuste en su sitio con un clic.

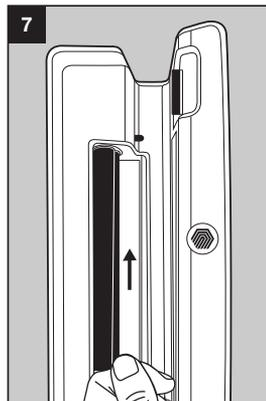
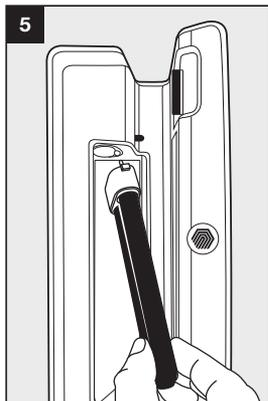
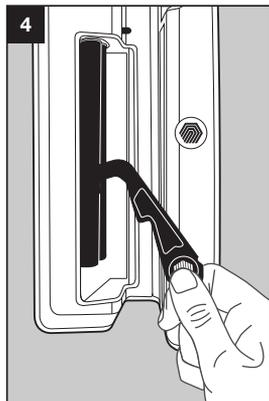

MANTENIMIENTO

- Limpiar solo con un pañuelo seco y suave
- No utilizar en ambientes húmedos
- Retire el enchufe de la toma al limpiarlo o cuando no esté en uso
- No utilizar bajo luz fuerte para un rendimiento óptimo

ESPECIFICACIONES

Dimensiones (w x d x h)	: 206 x 102 x 88 mm
Temperatura ambiente	: 0° C - 40° C (32° F - 104° F)
Humedad ambiente	: < 85%
Fuente de corriente	: 220-240V / 50Hz
Consumo de energía	: 11W max. (Safescan 50) / 16W max. (Safescan 70)

GARANTÍA



Este producto cumple los requisitos esenciales y otras disposiciones relevantes de las directivas europeas pertinentes. La Declaración de Conformidad (DoC) se puede consultar en www.safescan.com.



Si es posible, lleve la máquina a un centro de reciclaje tras su uso. No tire el producto a la basura doméstica.

NELLA CONFEZIONE

1. Rilevatore di contraffazioni Safescan 50 o 70
2. Manuale

PRODOTTO

PARTE
ANTERIORE

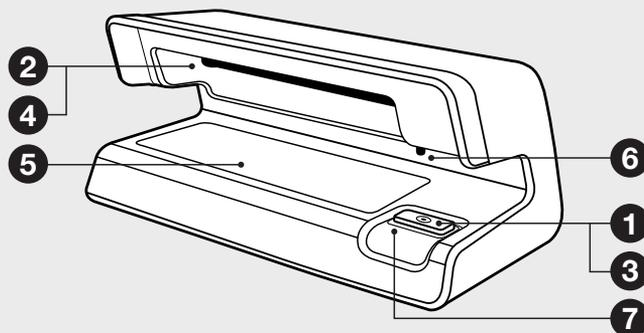

PARTE
POSTERIORE

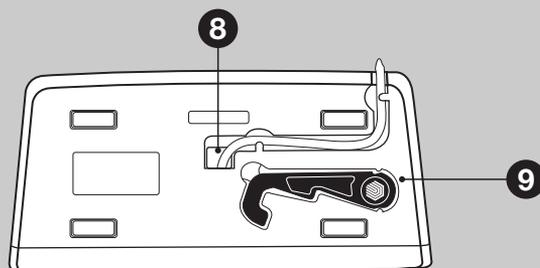

Safescan 50

1. Pulsante ON/OFF
2. Lampada a ultravioletti (UV)

Safescan 70

3. Pulsante di commutazione luce (UV/WL)
4. Lampada a ultravioletti (UV)
5. Luce bianca (WL)
6. Sensore di movimento
7. Indicatore luminoso

Safescan 50 e 70

8. Presa del cavo di alimentazione
9. Strumento per la rimozione della lampada UV

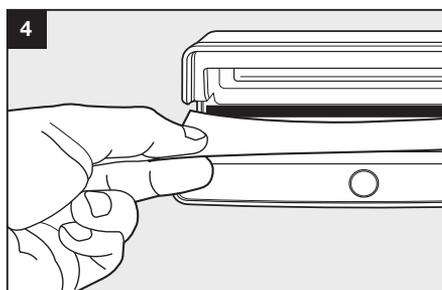
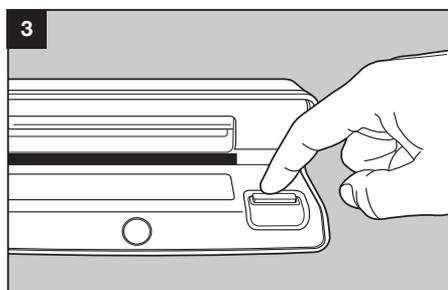
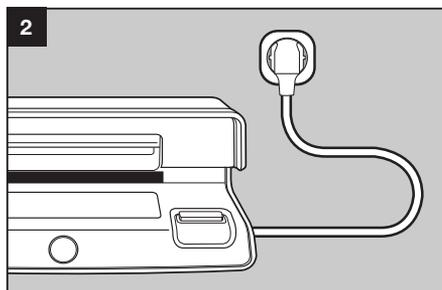
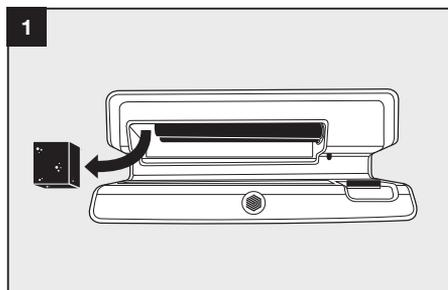
PER INIZIARE**ISTRUZIONI PER L'USO****Safescan 50**

Collegare la spina e premere il pulsante ON/OFF per verificare le caratteristiche UV su banconote e ID. Spegnerlo dopo l'uso.

Safescan 70

Collegare la spina e premere una volta il pulsante di commutazione luce per verificare con la luce UV le caratteristiche UV su banconote e ID. Premere nuovamente il pulsante di commutazione luce per verificare con la luce bianca la filigrana, il filo metallico e i micro caratteri. Se Safescan 70 non viene utilizzato per 20 secondi in modalità luce bianca o per 5 minuti in modalità luce UV, il dispositivo entra automaticamente in modalità standby.

Per uscire dalla modalità standby, tenere premuto per 5 secondi il pulsante di commutazione luce, fin quando si spegne l'indicatore luminoso. Dopo aver rilasciato il pulsante, l'indicatore lampeggia due volte. Ripetere per riattivare la modalità automatica standby. Per informazioni in merito alle caratteristiche di sicurezza delle banconote da osservare attentamente, visitate il sito www.euro.ecb.int (euro) o il sito web della banca nazionale locale (altre divise).

SOSTITUZIONE DELLA LAMPADA UV

1. Scollegare il dispositivo dalla presa di alimentazione.
2. Tenerlo in mano con il vano della lampada rivolto verso l'alto.
3. Estrarre lo strumento per la rimozione della lampada UV dal fondo del dispositivo.
4. Posizionare il gancio tra i 2 tubi ed estrarre delicatamente ma con decisione la lampada dal vano.
5. Rimuovere con attenzione la lampada dal dispositivo.
6. Voltare il dispositivo con il vano della lampada disposto verso il basso.
7. Posizionare delicatamente la nuova lampada nel vano e premerla finché non scatta in sede con un clic.

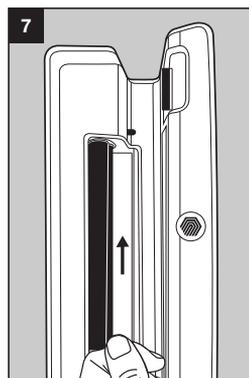
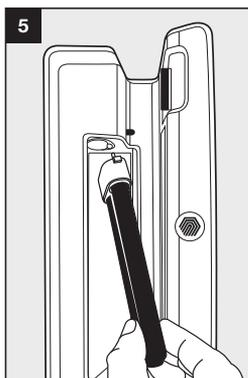
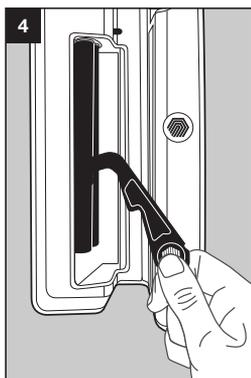

MANUTENZIONE

- Pulire esclusivamente con un panno morbido e asciutto
- Non utilizzare in ambienti umidi
- Rimuovere la spina dalla presa durante la pulizia o quando il dispositivo non è in uso
- Per un funzionamento ottimale, non utilizzare sotto luci forti

SPECIFICHE

Dimensioni (l x p x a)	: 206 x 102 x 88 mm
Temperatura ambiente	: 0° C - 40° C (32° F - 104° F)
Umidità ambiente	: < 85%
Alimentazione	: 220-240V / 50Hz
Consumo di energia	: 11W max. (Safescan 50) / 16W max. (Safescan 70)

GARANZIA



Il presente prodotto è conforme ai requisiti essenziali e alle altre disposizioni pertinenti delle direttive europee applicabili. La Dichiarazione di Conformità (DdC) è disponibile all'indirizzo www.safescan.com.



Se possibile, portare il dispositivo a un centro di riciclaggio dopo l'uso. Non smaltire il prodotto tra i rifiuti domestici.





Safescan® is a registered trademark of Solid Control Holding B.V. No part of this manual may be reproduced in any form, by print, copy or in any other way without prior written permission of Solid Control Holding B.V. Solid Control Holding B.V. reserves all intellectual and industrial property rights such as any and all of their patent, trademark, design, manufacturing, reproduction, use and sales rights. All information in this manual is subject to change without prior notice. Solid Control Holding B.V. is not liable and/or responsible in any way for the information provided in this manual. **1803**

Safescan®

www.safescan.com
info@safescan.com