

# ASSEMBLY INSTRUCTION 6929

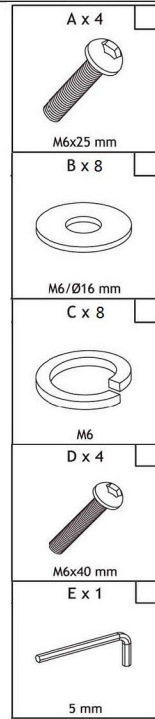

1

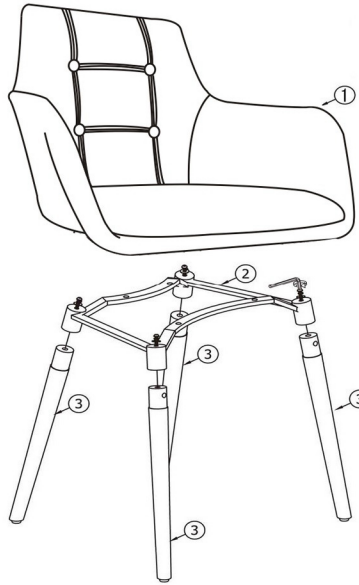
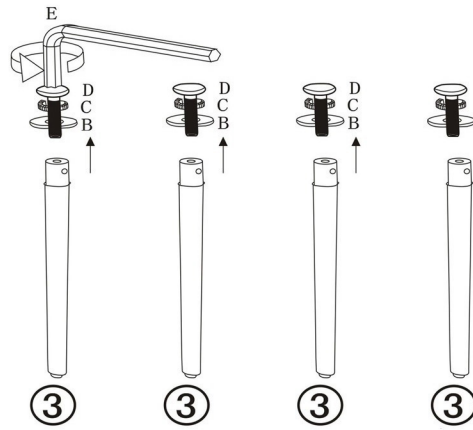
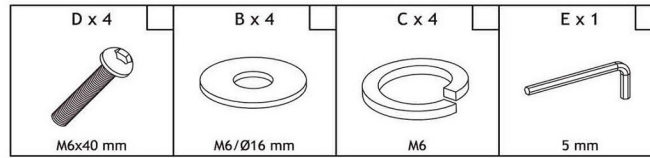

2

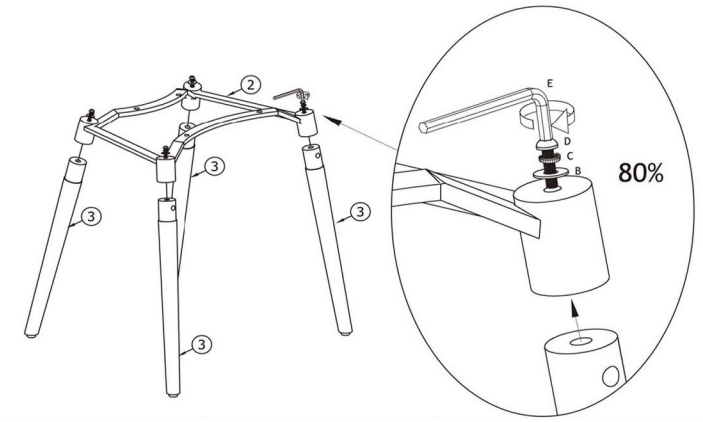
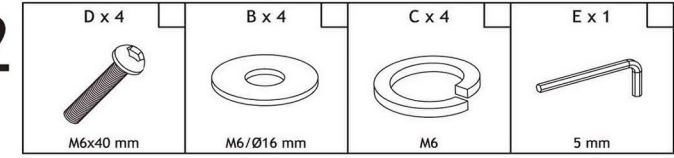

3

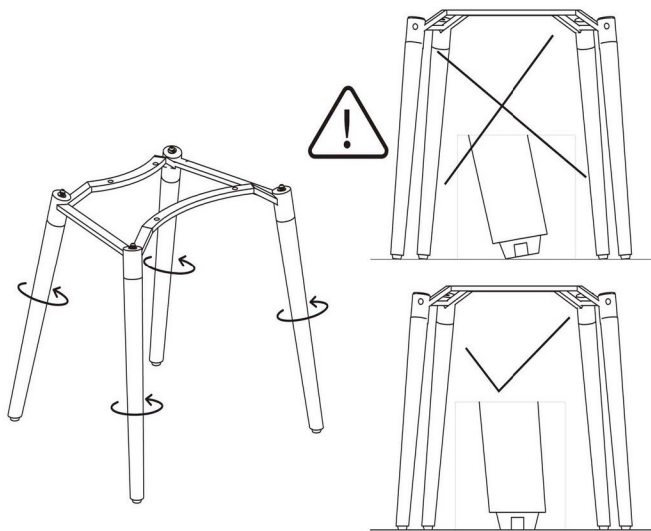

4

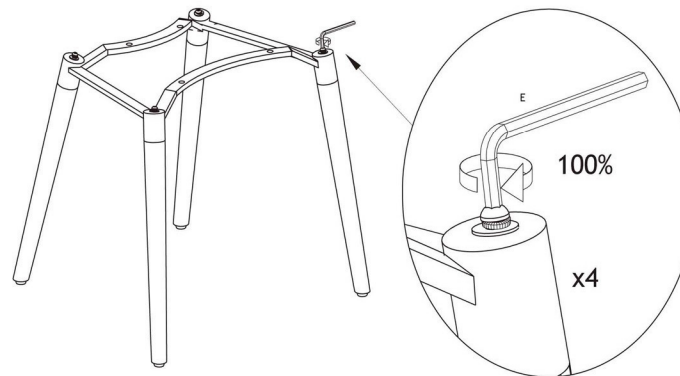
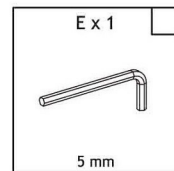

5

