

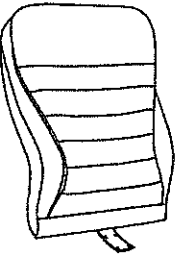





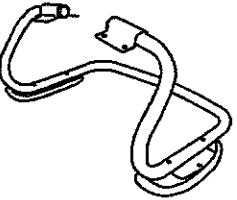
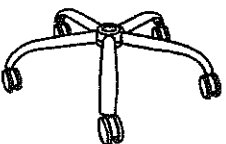

**IMPORTANT NOTICE:**  
**HARDWARE PACKAGE IS ATTACHED ON THE**  
**BOTTOM OF SEAT CUSHION.**

|   |   |   |
|---|---|---|
| (1)   | (2)   | (3)   |
|  |    |  |
| Back  | Seat & Mechanism  | Arm Frame   |
| (4)   | (5)   |   |
|  |    |   |
| L370 W/Casters  | Knee Tilt Gas Lift  |   |
| (A)-4pcs  |  | M6*30 BACK BAR SCREW  |
| (B)-1pcs  |  | M6*55 BACK SCREW  |
| (C)-1pcs  |  | CAP   |
| (D)-8pcs  |  | M6*25 ARM SCREW   |
| (E)-1pcs  |  | ALLEN KEY   |



**Max User Weight 350lbs/159Kilos**

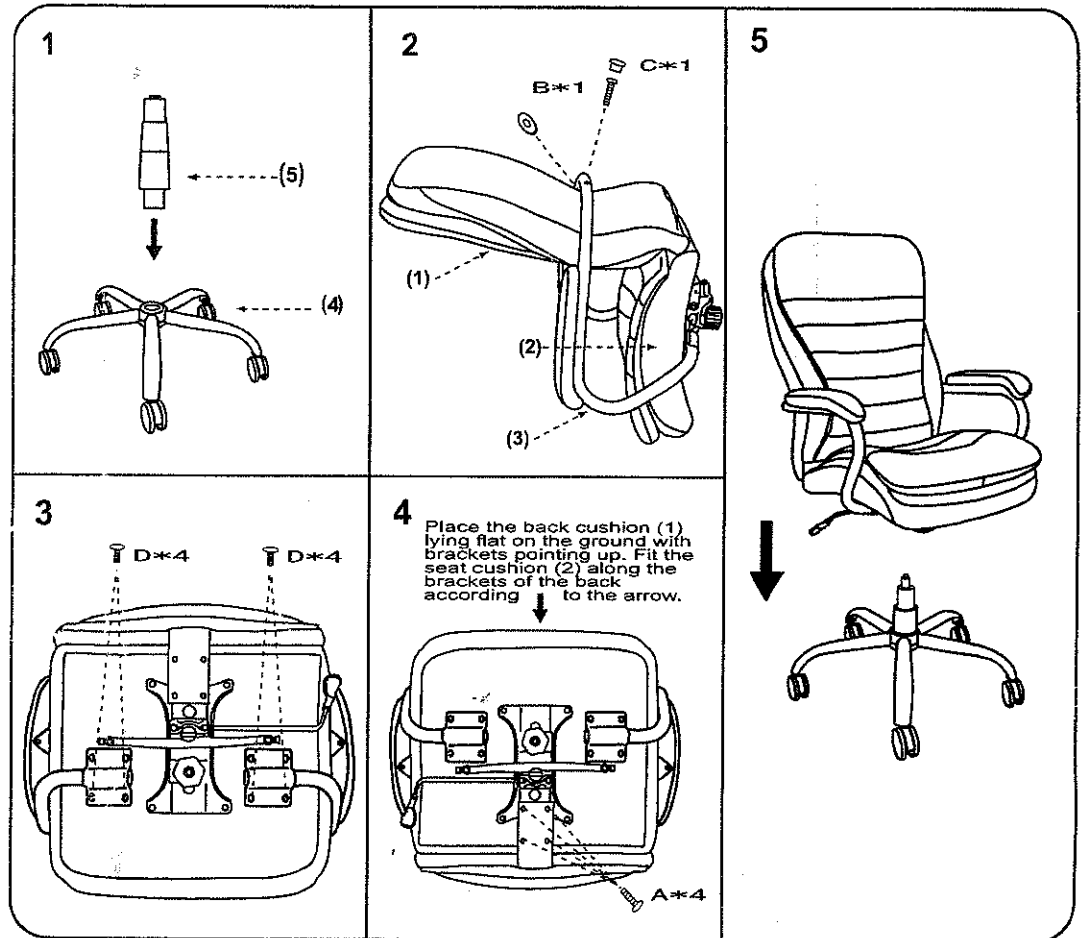
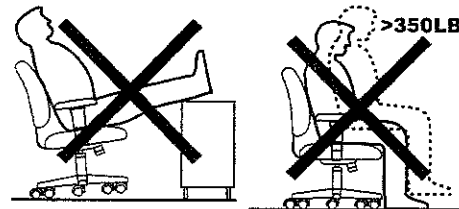

Teknik Office Ltd, West One 63-67 Bromham Road, Bedford, MK40 2FG TEL:01234 328804 FAX:01234 342446

If you encounter any problems with the operation of your chair, please refer to the downloads section of our web site - [www.teknikoffice.co.uk](http://www.teknikoffice.co.uk)