

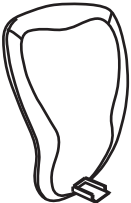







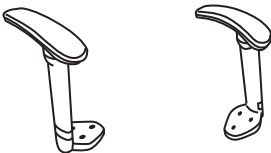
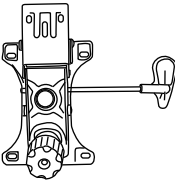

**VICTOR**

A		x1
B		x1
C		x5
D		x1
E		x1
F		x1
G		x1
H		x6
I		x7
J		x1

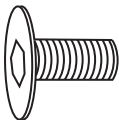
- (GB) Please note bolts are located in their fixing positions  
 (F) Veuillez noter que les boulons sont situés dans leur position de fixation  
 (I) Verificare che i bulloni siano posizionati nelle relative posizioni di fissaggio  
 (D) Hinweis: Die Bolzen befinden sich in ihren Befestigungspositionen  
 (ES) Por favor, observe que los pernos se sitan en sus posiciones de ajuste  
 (PT) Note que os parafusos esto posicionados nas suas posi es de fiza o  
 (NL) Let op: bouten zijn op de bevestigingspunten aangebracht

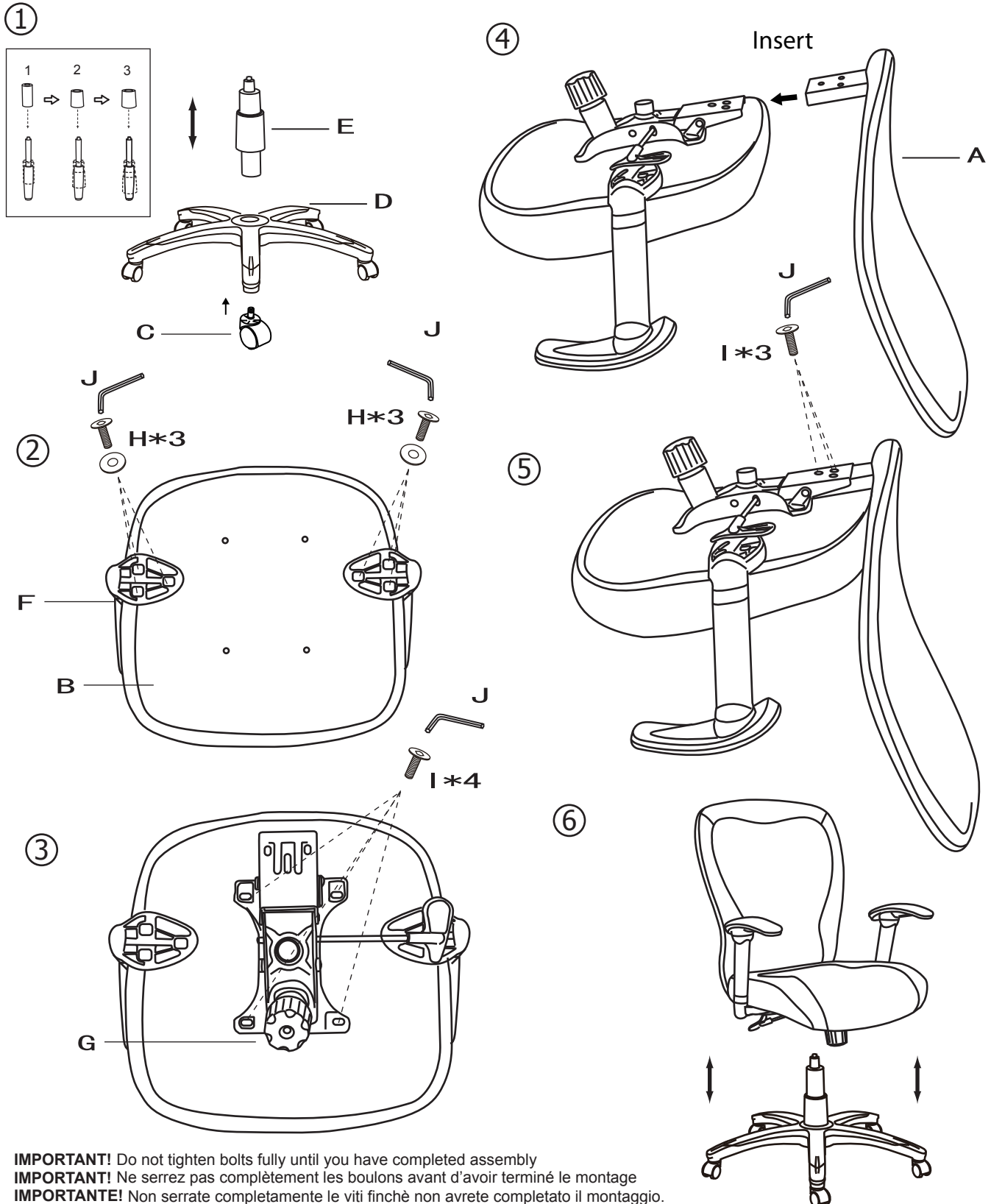

**IMPORTANT!** Do not tighten bolts fully until you have completed assembly  
**IMPORTANT!** Ne serrez pas complètement les boulons avant d'avoir terminé le montage  
**IMPORTANTE!** Non serrate completamente le viti finché non avrete completato il montaggio.  
**WICHTIG!** Schrauben erst nach vollständiger Montage fest anziehen.  
**IMPORTANTE!** No apriete en su totalidad los pernos hasta no haber completado el montaje.  
**BELANGRIJK!** Draai de bouten niet helemaal vast voordat u de stoel volledig in elkaar hebt gezet.

