

CORNER DESK-PANEL END

Assembly instruction

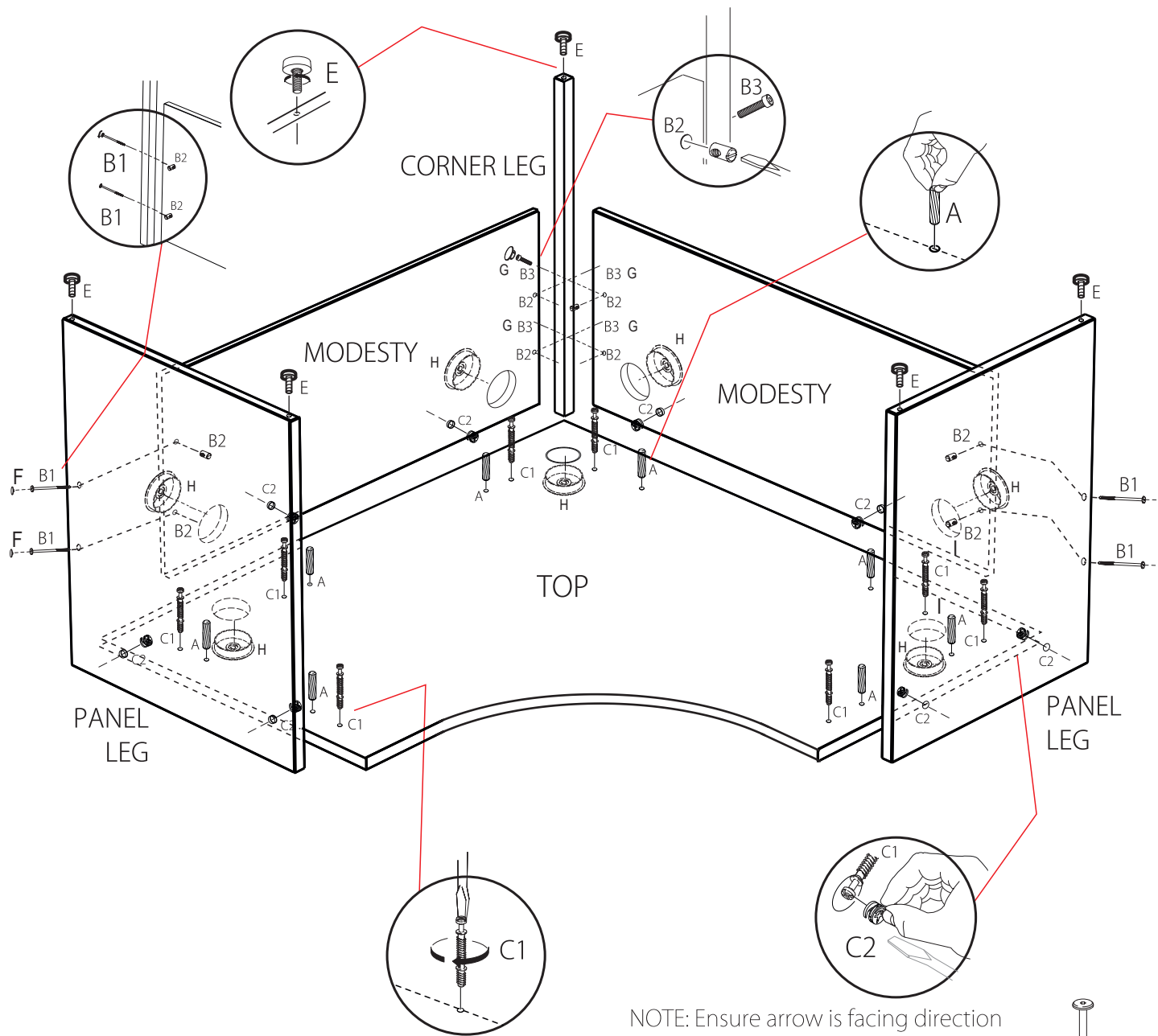





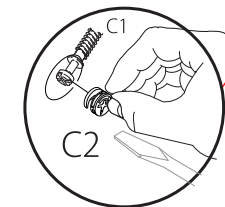
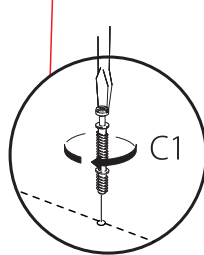



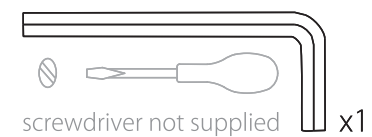

- 1) Separate all parts and fittings.
- 2) Check all parts you have received are correct.
- 3) Place the desk top upside down. This will require two people.
- 4) Attach all wooden dowels (A) to the desk top.
- 5) Attach all screws (C1) to the desk top.
- 6) Insert the cable ports into the modesty panel
- 7) Position the modesty panels on the desk. Ensure the dowels and screws are inserted into the correct holes.
- 8) Place the cam locks (C2) into position in the modesty panel and turn them to lock the modesty panel into place.
- 9) Insert the relevant cross dowels (B2) into the positions in the modesty panels.
- 10) Position the corner leg so the small holes are facing the modesty panels and insert the Screws (B3). The screws will need to be inserted all the way through the corner leg. Tighten to secure the leg to the desk.
- 11) Position the panel end legs on the desk. Ensure the dowels and screws are inserted into the correct holes.
- 12) Place the cam locks (C2) into position in the panel end leg and turn them to lock the panel end leg into place.
- 13) Insert the relevant cross dowels (B2) into position on the modesty panel.
- 14) Insert the screws (B1) into the panel end leg and tighten the screw (B1) into the cross dowel (B2) to secure the panel end leg to the modesty panel.
- 15) Screw the height adjusting feet (E) into the legs. Do not tighten too much as you may need to adjust the height when the desk is in position.
- 16) Go around all fittings a final time and ensure they are secure.
- 17) When turning the desk over it is important to remember that a two-person lift will mean you do not damage the assembly.
- 18) Insert the cable ports into the desk top.

If your desk requires moving after assembly, please lift with 2 people to prevent any damage to the assembly.



NOTE: Ensure arrow is facing direction of the screw head before tightening



-  Ax8
-  B1x4
-  B2x8
-  B3x4
-  C1x8
-  C2x8
-  Ex5
-  Fx4
-  Gx4
-  Hx7