

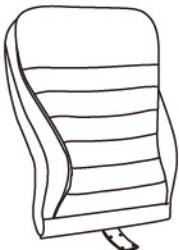







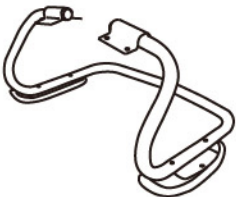

**IMPORTANT NOTICE:
HARDWARE PACKAGE IS ATTACHED ON THE
BOTTOM OF SEAT CUSHION.**

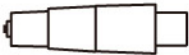
(1)	(2)	(3)
		
Back	Seat & Mechanism	Arm Frame
(4)	(5)	
		
L370 W/Casters	Knee Tilt Gas Lift	
(A)-4pcs		M6*30 BACK BAR SCREW
(B)-1pcs		M6*55 BACK SCREW
(C)-1pcs		CAP
(D)-8pcs		M6*25 ARM SCREW
(E)-1pcs		ALLEN KEY



Max User Weight 350lbs/159Kilos

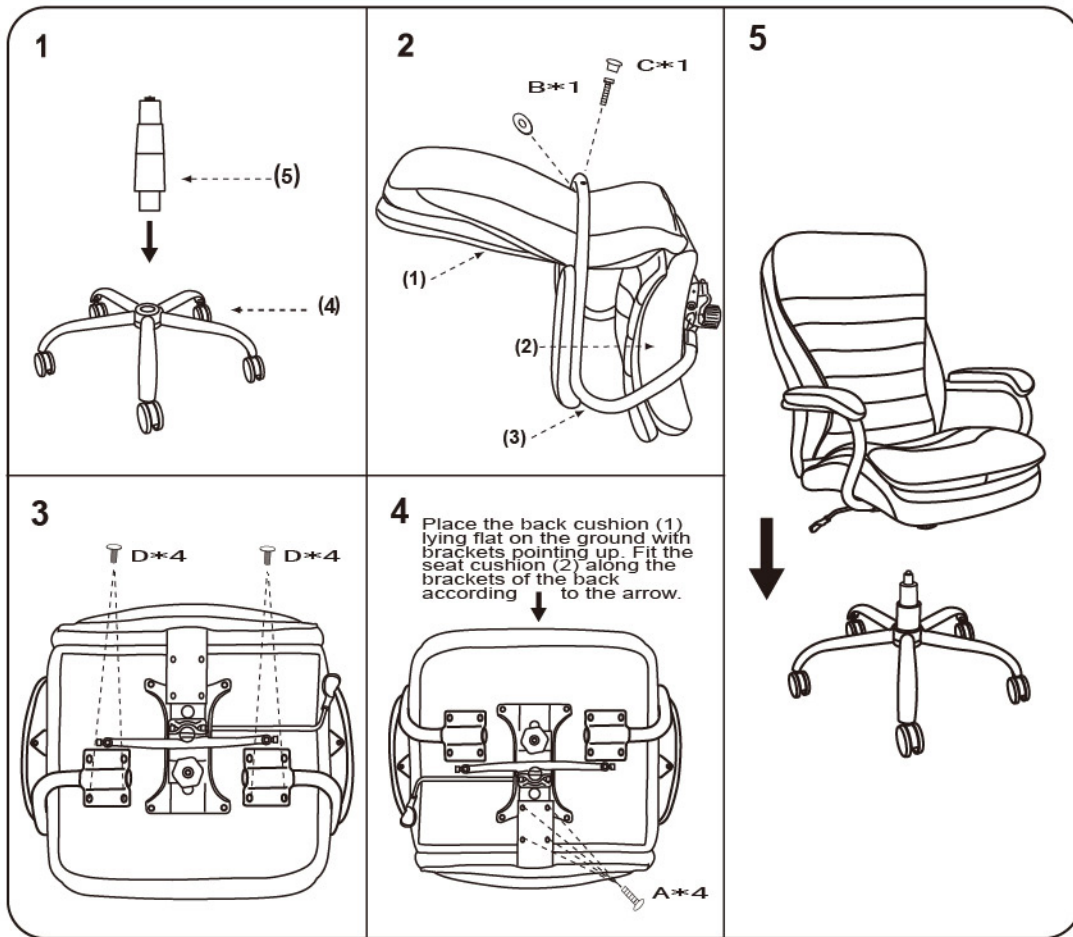