

BOAT SHAPE CONFERENCE TABLE

MODEL:CF015/CF016

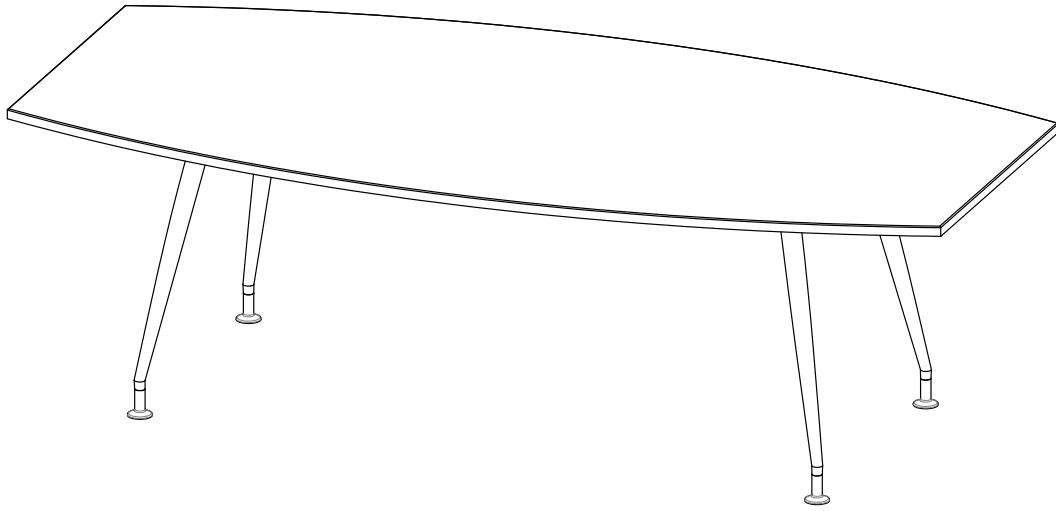
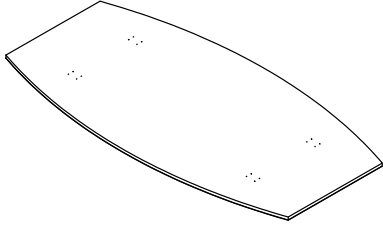
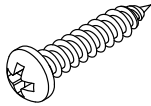
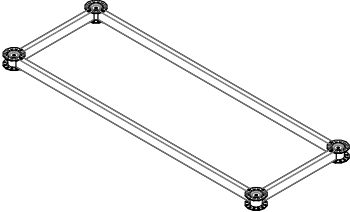
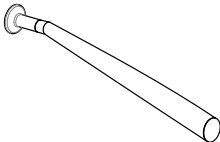

MAIN COMPONENT		FITTING PACKAGE	
ITEM	NAME	ITEM	NAME
1	DESK TOP 1PCS 	A	SCREWS 16PCS 
	2		METAL FRAME 1PCS 
3	METAL LEG 4PCS 		

1. Install Metal Frame:

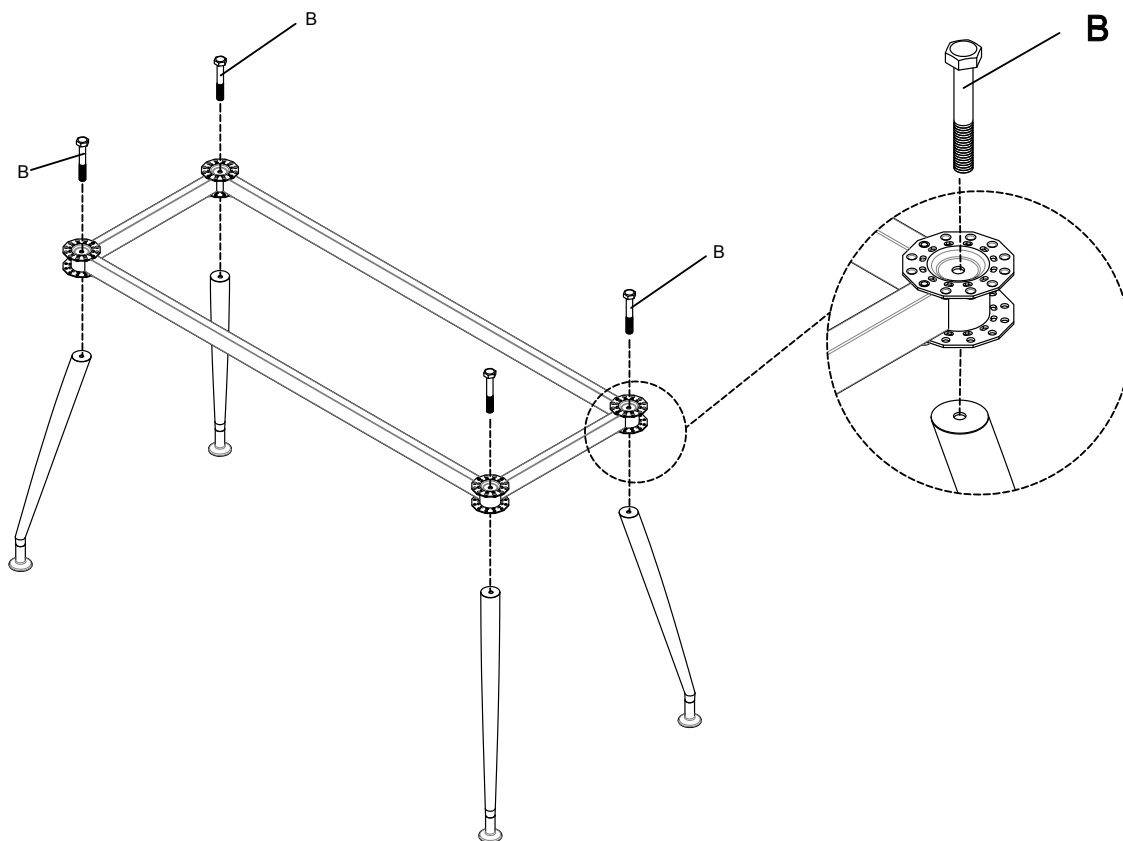

2. Install Desk Top :

IMPORTANT: TO AVOID DAMAGING THE TABLE TOP PLEASE ENSURE THAT IT IS LAID IN ITS CARDBOARD BOX DURING ASSEMBLY AND NOT ON ANY ROUGH SURFACES.

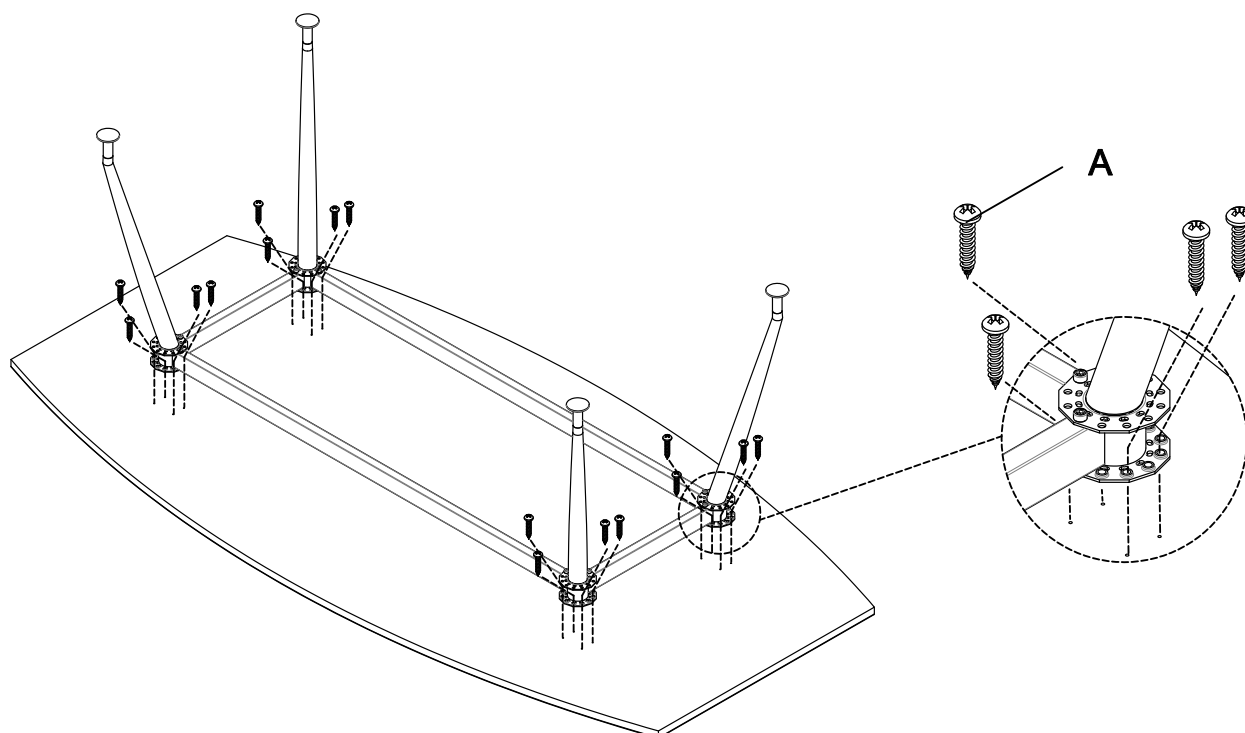

3. AFTER ASSEMBLY REMEMBER TO PEEL THE TRANSPARENT LAMINATE FILM FROM THE TABLE TOP.