

Single Monitor Desk Mount - Height Adjustable - For up to 30" Monitor



**Actual product may vary from photos*

User Manual

SKU: 1MP1ACG-MONITOR-ARM

For the latest information and specifications visit
www.StarTech.com/1MP1ACG-MONITOR-ARM

Compliance Statements

Use of Trademarks, Registered Trademarks, and other Protected Names and Symbols

This manual may make reference to trademarks, registered trademarks, and other protected names and/or symbols of third-party companies not related in any way to StarTech.com. Where they occur these references are for illustrative purposes only and do not represent an endorsement of a product or service by StarTech.com, or an endorsement of the product(s) to which this manual applies by the third-party company in question. Regardless of any direct acknowledgement elsewhere in the body of this document, StarTech.com hereby acknowledges that all trademarks, registered trademarks, service marks, and other protected names and/or symbols contained in this manual and related documents are the property of their respective holders.

PHILLIPS® is a registered trademark of Phillips Screw Company in the United States or other countries.

Safety Statements

Safety measures

- Product installation and/or mounting should be completed by a certified professional as per the local safety and building code guidelines.

Mesures de sécurité

- L'installation et/ou le montage du produit doit être réalisé par un professionnel certifié et dans le respect des normes locales et du code de construction local.

Säkerhetsåtgärder

- Installation och/eller montering får endast göras av behöriga yrkespersoner och enligt gällande lokala förordningar för säkerhet och byggnormer.

Veiligheidsmaatregelen

- De installatie en/of montage van het product moet worden uitgevoerd door een erkend vakman volgens de plaatselijke veiligheids- en bouwvoorschriften.

安全対策

- 製品の設置やマウントは、使用地域の安全ガイドラインおよび建築基準に従い、有資格の専門業者が行うようにしてください。

Misure di sicurezza

- L'installazione e/o il montaggio dei prodotti devono essere eseguiti da un tecnico professionale certificato che conosca le linee guida locali sulle norme edilizie e sulla sicurezza.

Medidas de seguridad

- La instalación y/o montaje del producto debe ser realizada por un profesional certificado de acuerdo con las directrices de los códigos locales de seguridad y construcción.

Sicherheitsmaßnahmen

- Die Installation und/oder Montage des Produkts sollte von einem zertifizierten Fachmann gemäß den örtlichen Sicherheits- und Bauvorschriften durchgeführt werden.

Warning Statements

- StarTech.com Ltd. is not responsible for any property damage and/or personal injury resulting from the installation procedures outlined in this technical document.
- Assemble this product according to the instructions. Read the entire manual and ensure the instructions are fully understood before assembling and/or using this product.
- Do not exceed the weight capacity of this product. Overloading this product might result in personal injury or property damage.
- The Weight capacity of the monitor arm: 4.4 to 19.8 lb (2 to 9 kg).
- Do not allow children to climb on this product or to use this product without proper supervision.
- This product is intended for indoor use only and should not be used outdoors.
- Do not over-tighten the screws. If any resistance is encountered, stop tightening.
- Assembling this product is a two-person task. Do not attempt to assemble this product and install equipment without assistance.
- Before adding equipment to this product, ensure the product has been properly assembled, and that the product can support the weight of the added equipment.
- Make sure all of the equipment has been properly secured before adjusting this product.
- **Stored Energy Hazard!** This product contains a spring mechanism which can cause the assembly and/or mounted equipment to move forcibly, and quickly, upwards. Always exercise caution when handling, or in close proximity to, the spring arm(s). Do not remove the mounted equipment unless the spring arm is moved to the highest position or (if possible) the spring force is adequately lowered to remove any danger posed. Failure to do so may result in property damage and/or serious personal injury.
- **Pinch hazards!** Keep hands away from any pinch points created by the mechanical components when lowering or raising the display. Failure to do so may result in serious personal injury.

Avertissements

- StarTech.com Ltd. n'est pas responsable des dommages matériels et/ou corporels résultant des procédures d'installation décrites dans ce document technique.
- Assemblez ce produit conformément aux instructions. Lisez l'intégralité

du manuel et assurez-vous que les instructions sont bien comprises avant d'assembler et/ou d'utiliser ce produit.

- Ne dépassez pas la capacité de poids de ce produit. La surcharge de ce produit peut entraîner des blessures ou des dommages matériels.
- Capacité de poids du bras de moniteur: de 4,4 à 19,8 lb (2 à 9 kg).
- Ne laissez pas les enfants grimper sur ce produit ou l'utiliser sans surveillance adéquate.
- Ce produit est destiné à être utilisé à l'intérieur uniquement et ne doit pas être utilisé à l'extérieur.
- Ne serrez pas trop les vis lors de l'assemblage de ce produit. Si vous rencontrez une résistance lors du serrage des vis, cessez de serrer.
- L'assemblage de ce produit nécessite deux personnes. Ne tentez pas d'assembler le produit et d'installer les équipements sans aide.
- Avant d'ajouter des équipements au produit, vérifiez que vous l'avez correctement assemblé et installé, et que le produit peut supporter le poids des équipements que vous y ajoutez.
- Assurez-vous que tout l'équipement a été correctement fixé avant de régler ce produit.
- Danger lié à l'énergie stockée ! Ce produit contient un mécanisme à ressort qui peut provoquer un déplacement forcé et rapide de l'ensemble et/ou de l'équipement monté vers le haut. Faites toujours preuve de prudence lorsque vous manipulez le(s) bras à ressort ou que vous vous trouvez à proximité de celui-ci. Ne retirez pas l'équipement monté tant que le bras à ressort n'a pas été placé dans la position la plus haute ou (si possible) que la force du ressort n'a pas été suffisamment réduite pour éliminer tout danger. Le non-respect de cette consigne peut entraîner des dommages matériels et/ou des blessures corporelles graves.
- Risques de pincement ! Gardez les mains à l'écart de tout point de pincement créé par les composants mécaniques lorsque vous abaissez ou relevez l'écran. Le non-respect de cette consigne peut entraîner des blessures corporelles graves.

Varningsmeddelanden

- StarTech.com Ltd. ansvarar inte för eventuella skador på egendom och/eller personskador till följd av de installationsprocedurer som beskrivs i detta tekniska dokument.
- Montera produkten enligt instruktionerna. Läs hela manualen och se till att du har förstått instruktionerna innan du monterar och/eller använder produkten.
- Överskrid inte produktens viktkapacitet. Överbelastning av produkten kan

- leda till skador på person eller egendom.
- Viktkapaciteten för monitorarmen är 2 till 9 kg.
 - Låt varken barn klättra på den här produkten eller använda den utan lämplig tillsyn.
 - Produkten är endast avsedd för användning inomhus och ska inte användas utomhus.
 - Dra inte åt skruvarna för hårt när du monterar produkten. Om du måste ta i när du skruvar åt kan du sluta skruva åt.
 - Det krävs Monitorå personer för att montera produkten. Försök inte montera produkten och installera utrustning utan hjälp.
 - Innan du lägger till utrustning på produkten, se till att produkten är korrekt monterad, installerad och att produkten klarar av vikten på utrustningen som du lägger till.
 - Se till att all utrustning är ordentligt säkrad innan du justerar produkte
 - Risk för lagrad energi! Den här produkten innehåller en fjädermekanism som kan leda till att monteringen och/eller den monterade utrustningen rör sig kraftigt och snabbt uppåt. Var alltid försiktig när du hanterar eller är i närheten av fjäderarmen/fjäderarmarna. Avlägsna inte den monterade utrustningen om inte fjäderarmen har flyttats till det högsta läget eller (om möjligt) om inte fjäderkraften har sänkts tillräckligt för att undanröja eventuell fara. Underlåtenhet att göra detta kan leda till egendomsskador och/eller allvarlig personskada.
 - Klämrisk! Håll händerna borta från eventuella klämpunkter som skapas av de mekaniska komponenterna när du sänker eller lyfter displayen. Underlåtenhet att göra detta kan leda till allvarliga personskador.

Waarschuwingen

- StarTech.com Ltd. is niet verantwoordelijk voor materiële schade en/of persoonlijk letsel als gevolg van de in dit technische document beschreven installatieprocedures.
- Monteer dit product volgens de instructies. Lees de gehele handleiding en zorg ervoor dat u de instructies volledig begrijpt voordat u dit product monteert en/of gebruikt.
- Overschrijd het maximaal draagvermogen van dit product niet. Overbelasting van dit product kan leiden tot persoonlijk letsel of materiële schade.
- Gewichtscapaciteit van de monitorarm: 2 tot 9 kg.
- Laat kinderen niet op dit product klimmen of dit product gebruiken zonder behoorlijk toezicht.
- Dit product is uitsluitend bedoeld voor gebruik binnenshuis en mag niet

buitenshuis worden ingezet.

- Draai de schroeven niet te strak vast wanneer u dit product in elkaar zet. Als u weerstand voelt tijdens het vastdraaien van de schroeven, stop dan.
- Dit product moet met twee personen in elkaar worden gezet. Probeer dit product niet zonder hulp in elkaar te zetten en apparatuur te installeren.
- Voordat u apparatuur aan dit product toevoegt, moet u ervoor zorgen dat u het op de juiste manier in elkaar hebt gezet en geïnstalleerd, en dat het product het gewicht van de toe te voegen apparatuur kan ondersteunen.
- Controleer of alle apparatuur goed is vastgezet voordat u dit product afstelt.
- Gevaar door opgeslagen energie! Dit product bevat een veermechanisme dat de assemblage en/of de gemonteerde apparatuur hevig en snel omhoog kan doen bewegen. Wees altijd voorzichtig bij het hanteren of in de nabijheid zijn van de veerarm(en). Verwijder de gemonteerde unit pas nadat de veerarm in de hoogste stand is gezet of (indien mogelijk) de veerkracht voldoende is verlaagd om elk gevaar uit te sluiten. Doet u dit niet, dan kan dit leiden tot materiële schade en/of ernstig persoonlijk letsel.
- Gevaar voor klemmen! Houd uw handen uit de buurt van de knelpunten van de mechanische onderdelen wanneer u het display laat zakken of optilt. Doet u dit niet, dan kan dit leiden tot ernstig persoonlijk letsel.

注意

- StarTech.com K.K.は、この技術文書に記載されているインストール手順に起因するいかなる物的損害および/または人身事故に対して責任を負うものではありません。
- 本製品は、必ず取扱説明書に従って組み立ててください。本製品を組み立てたり、使用する前に、必ず取扱説明書全文をよく読み、その内容を十分に理解してから取り扱ってください。
- 本製品の耐荷重を超えないようご注意ください。本製品に耐荷重以上の負荷がかかると、人身事故や物的損害が発生する恐れがあります。
- モニターアームの重量容量: 2~9 kg。
- 子供が、本製品に登ったり、保護者の監視なしに本製品を使用しないでください。
- 本製品は屋内での使用のみを想定しているため、屋外では使用しないでください。
- 本製品を組み立てる際、ネジを締めすぎないようにして下さい。ネジを締めているうちに手応えを感じたら、締めるのを止めてください。
- 本製品は、二人がかりでの組み立てを想定しています。手助けなしに単独で組み立てと設置を行わないで下さい。
- 本製品に機器を追加する前に、本製品が適切に組み立てられていること、および本製品が追加した機器の重量を支えることができることを確認して

- ください。
- 本製品を調整する前に、すべての機器が適切に固定されていることを確認してください。
 - バネの弾性反動に注意!本製品にはスプリング機構が搭載されており、作動させるとアセンブリ部品やディスプレイが反動で上方向に大きく動く場合があります。スプリングアームを取り扱う際、またはスプリングアームに近接する際は、十分に注意を払ってください。スプリングアームを最も高い位置に移動させるか、(可能であれば)バネの力を十分に弱めて安全を確保できるようにするまで、搭載された機器を取り外さないでください。物的損害や重大な人身事故を引き起こす可能性があります。
 - 挟まれ注意!ディスプレイを下げたり上げたりするときには、機械部品に挟まれる可能性がある部分に手を近づけないでください。重傷を負う可能性があります。

Dichiarazioni di avvertenza

- StarTech.com Ltd. non è responsabile per eventuali danni a cose e/o persone derivanti dalle procedure di installazione descritte in questo documento tecnico.
- Assemblare il prodotto seguendo le istruzioni. Prima di assemblare e/o utilizzare il prodotto, leggere l'intero manuale e assicurarsi che le istruzioni siano state comprese appieno.
- Non superare la capacità di peso del prodotto. Il sovraccarico del prodotto può causare lesioni personali o danni materiali.
- Capacità di peso del braccio del monitor: da 2 a 9 kg.
- Non consentire ai bambini di salire su questo prodotto o di utilizzarlo senza un'adeguata supervisione.
- Questo prodotto è destinato esclusivamente all'uso interno e non deve essere utilizzato all'aperto.
- Durante l'assemblaggio del prodotto, non stringere troppo le viti. Se si incontra resistenza mentre si stringono le viti, interrompere l'operazione.
- L'assemblaggio di questo prodotto richiede la presenza di due persone. Non tentare di assemblare il prodotto e installare le apparecchiature senza assistenza.
- Prima di aggiungere altre apparecchiature al prodotto, assicurarsi di averlo assemblato e installato correttamente e che sia in grado di sostenere il peso dell'apparecchiatura in questione.
- Assicurarsi che tutte le apparecchiature siano state fissate correttamente prima di regolare il prodotto.
- Questo prodotto contiene un meccanismo a molla che può far muovere forzatamente e rapidamente verso l'alto il dispositivo e/o l'apparecchiatura

montata. Prestare sempre attenzione quando si maneggiano o si è in prossimità dei bracci a molla. Non rimuovere l'apparecchiatura montata se il braccio a molla non è stato spostato nella posizione più alta o (se possibile) la forza della molla non è stata adeguatamente abbassata per eliminare il pericolo. In caso contrario, si possono verificare danni alle cose e/o gravi lesioni personali.

- Pericolo di schiacciamento mani! Tenere le mani lontane da qualsiasi punto di schiacciamento/pizzicatura creato dai componenti meccanici quando si abbassa o si alza il display. L'inosservanza di questa avvertenza può provocare gravi lesioni personali.

Advertencias de uso

- StarTech.com Ltd. no se responsabiliza de los daños materiales y/o personales derivados de los procedimientos de instalación descritos en este documento técnico.
- Monte este producto siguiendo las instrucciones. Lea todo el manual y asegúrese de que las instrucciones se entienden completamente antes de montar y/o utilizar este producto..
- No exceda la capacidad de peso de este producto. Sobrecargar este producto podría provocar lesiones personales o daños materiales.
- Capacidad de peso del brazo del monitor: 2 a 9 kg.
- No permita que niños se suban a este producto ni que lo utilicen sin la debida supervisión.
- Este producto está destinado únicamente para uso en interiores y no debe utilizarse en exteriores.
- Cuando ensamble este producto, no apriete los tornillos más de lo debido. Si al apretar los tornillos siente resistencia, no los apriete más.
- Por su seguridad y para evitar lesiones, se recomienda la presencia de dos personas durante el proceso de instalación. Intentar instalar el producto solo puede provocar lesiones personales o daños al producto.
- Antes de instalar equipos en este producto, asegúrese de haberlo ensamblado correctamente, a fin de que pueda soportar el peso del equipo que vaya a instalar
- Compruebe siempre que el equipo está bien sujeto al producto antes de utilizarlo.
- ¡Peligro de Energía Almacenada! Este producto contiene un mecanismo de resorte que puede hacer que los componentes del conjunto y/o la pantalla se muevan rápidamente con fuerza hacia arriba al ser accionados. Siga las instrucciones proporcionadas y tenga siempre precaución al accionar la manija. No la accione antes del paso 4 del procedimiento de instalación.

Quando ajuste la altura de la pantalla, sujete o sosténgala siempre con ambas manos (como se muestra) para controlar con seguridad la subida o bajada de la misma. Si no lo hace, puede provocar daños materiales y/o lesiones personales graves.

- ¡Peligro de machucado! Mantenga las manos alejadas de cualquier punto de machucado creado por los componentes mecánicos, al bajar o al subir la pantalla. Si no lo hace, puede resultar en lesiones personales graves.

Warnhinweise

- StarTech.com Ltd. ist nicht verantwortlich für Sach- und/oder Personenschäden, die durch die in diesem technischen Dokument beschriebenen Installationsverfahren entstehen.
- Bauen Sie dieses Produkt gemäß der Anleitung zusammen. Lesen Sie das gesamte Handbuch und stellen Sie sicher, dass Sie die Anweisungen vollständig verstanden haben, bevor Sie dieses Produkt zusammenbauen und/oder verwenden.
- Überschreiten Sie nicht die Tragkraft dieses Produkts. Eine Überlastung dieses Produkts kann zu Verletzungen oder Sachschäden führen.
- Gewichtskapazität des Monitorarms: 2 bis 9 kg.
- Kinder sollten nicht auf dieses Produkt klettern oder dieses Produkt ohne angemessene Aufsicht verwenden.
- Dieses Produkt ist nur für die Verwendung in Innenräumen bestimmt und sollte nicht im Freien verwendet werden.
- Ziehen Sie die Schrauben nicht zu fest an. Wenn Sie auf Widerstand stoßen, hören Sie auf, die Schrauben anzuziehen.
- Die Montage dieses Produkts ist auf die Ausführung von zwei Personen ausgelegt. Versuchen Sie nicht ohne Hilfe, dieses Produkt zu montieren und Geräte zu installieren.
- Bevor Sie Geräte zu diesem Produkt hinzufügen, vergewissern Sie sich, dass Sie es ordnungsgemäß montiert und installiert haben und dass das Produkt das Gewicht der Geräte, die Sie hinzufügen möchten, tragen kann.
- Vergewissern Sie sich, dass alle Geräte ordnungsgemäß gesichert sind, bevor Sie dieses Produkt einstellen.
- Gefahr durch gespeicherte Energie! Dieses Produkt enthält einen Federmechanismus, der dazu führen kann, dass sich die Montageteile und/oder das Display bei Betätigung gewaltsam und schnell nach oben bewegen. Befolgen Sie die mitgelieferten Anweisungen und lassen Sie bei der Betätigung des Griffs stets Vorsicht walten. Betätigen Sie den Griff nicht vor Schritt 4 des Installationsverfahrens. Wenn Sie das Display in der Höhe verstellen, stützen Sie es immer mit beiden Händen (wie abgebildet), um

das Anheben oder Absenken des Displays sicher zu steuern. Nichtbeachtung kann zu Sachschäden und/oder schweren Verletzungen führen.

- Einklemmgefahr! Halten Sie beim Absenken oder Anheben des Displays die Hände von den durch die mechanischen Komponenten verursachten Klemmstellen fern. Andernfalls kann es zu schweren Verletzungen kommen.

Table of Contents

Compliance Statements	i
Safety Statements	ii
Warning Statements	iii
Product Diagram	1
Product Dimensions	2
Side View and Front Profile.....	2
Product Information	3
Requirements	3
Package Contents.....	4
Installation	5
Desk Installation	5
Convert from Desk Mount to Grommet Mount.....	7
Grommet Installation	9
Convert from Grommet Mount to Desk Mount (Optional).....	10
Adjust the Desk Clamp for Different Desk Thicknesses (Optional)	11
Attach the Monitor Arms	12
Attach the Monitor	15
Operation	17
Adjust the Swivel and Tilt Tension	17
Adjust the Swivel Tension	17
Adjust the Tilt Tension	17
Cable Management.....	19

Warranty Information	20
Limitation of Liability	20

Product Diagram

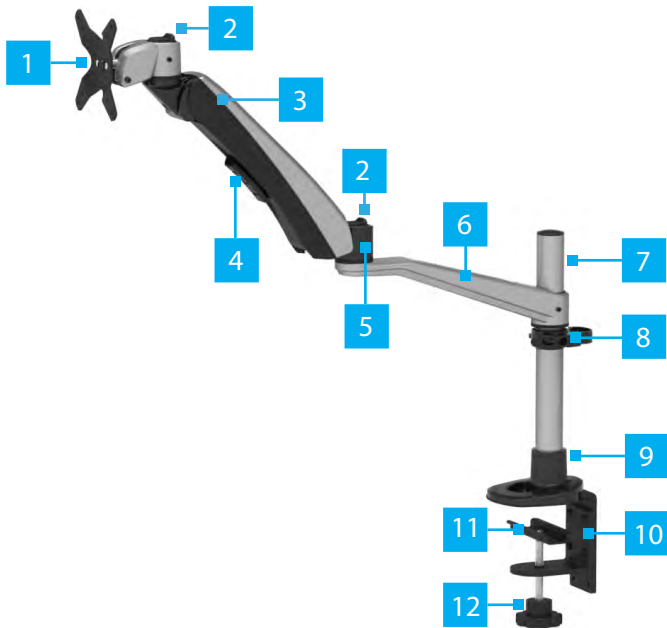

*Actual product may vary from photos

1	VESA Monitor Mount	5	Spring Arm, Mounting Post	9	Pole Base
2	Release Button	6	Swivel Arm	10	Desk Clamp
3	Monitor Spring Arm	7	Pole	11	Clamping Plate
4	Cable Management Channel	8	Cable Management Clip	12	Hand Knob

To view manuals, videos, drivers, downloads, technical drawings, and more visit www.startech.com/support

Product Dimensions

Side View and Front Profile

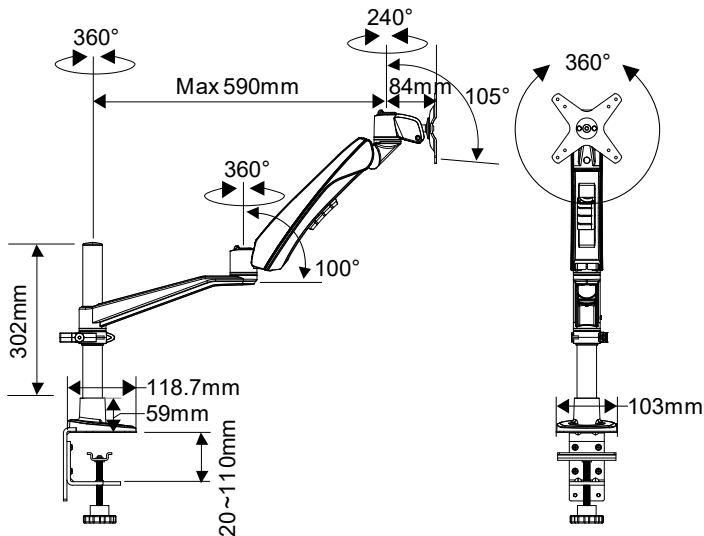

Product Information

Requirements

For the latest product information, technical specifications, manuals, and Declarations of Conformance, please visit:

www.StarTech.com/1MP1ACG-MONITOR-ARM







Monitor Mount

- Weight of 4.4 to 19.8 lb (2 to 9 kg)
- Compatible VESA mounting hole pattern of 75 x 75 or 100 x 100 mm
- Display size up to 30"

Tools

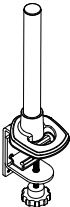
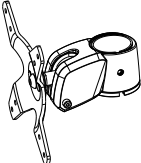
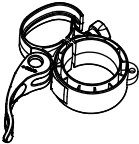
- Phillips head screwdriver

Package Contents

 <p>Spring Arm Quantity: 1</p>	 <p>Swivel Arm Quantity: 1</p>	 <p>Pole Mount Assembly Quantity: 1</p>	 <p>VESA Monitor Mount Quantity: 1</p>
 <p>Cable Management Clip Quantity: 1</p>	 <p>Hex Key Quantity: 1</p>	 <p>Monitor Thumbscrews Quantity: 4</p>	 <p>Base Cushion Quantity: 1</p>
 <p>User Manual Quantity: 1</p>			

To view manuals, videos, drivers, downloads, technical drawings, and more visit www.startech.com/support

Installation

Desk Installation

1. Adjust the **Thumbscrew** on the **Desk Clamp** to match the **Thickness** of the **Desk**. (Figure 1)

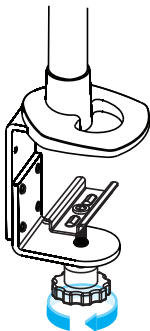

Figure 1

2. Remove the **Protective film** from the **Base Cushion** to reveal the **Self-Adhesive**.
3. Ensure to **Line Up** the **Hole** on the **Pole Assembly Base** with the corresponding **Hole** on the **Adhesive Side** of the **Base Cushion**. Affix the **Base cushion** to the **Pole Assembly Base** by applying **Pressure** for a few seconds for the **Adhesive** to set.
4. Slide the **Desk Clamp** onto the **Desk**. (Figure 2)

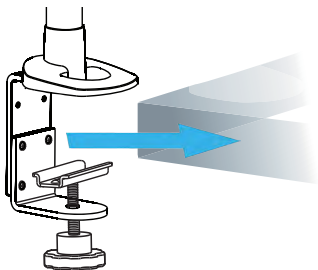

Figure 2

5. Use the **Hand Knob** to **Tighten** and secure the **Desk Clamp** onto the **Desk**. (Figure 3)

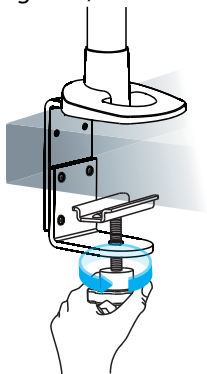

Figure 3

Convert from Desk Mount to Grommet Mount

1. Rotate the **Pole Mount Assembly** so that the **Pole** faces downwards. Use the **Hex Key** to **Remove** the **Hex Screws** (x4) that are holding the base of the **Pole** to the **Desk Clamp**. (Figure 4)

Note: *Adjust the Hand Knob to have enough room to remove the Hex Screws.*

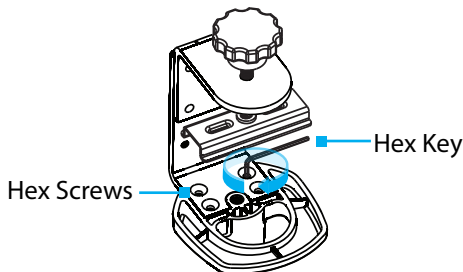

Figure 4

2. Use a **Phillips Head Screwdriver** to remove the **Screw** from the **Clamping Plate** attached onto the **Hand Knob**. (Figure 5)

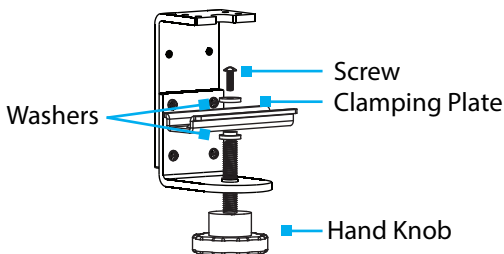

Figure 5

3. Remove the **Clamping Plate**, **Washers** (x2), and the **Hand Knob** from the **Desk Clamp**.
4. Insert the **Clamping Plate** back onto the **Hand Knob**. (Figure 6)

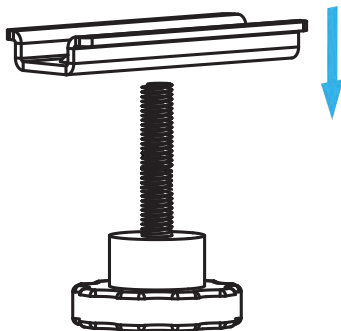

Figure 6

Grommet Installation

1. Remove the **Protective film** from the **Base Cushion** to reveal the **Self-Adhesive**.
2. Ensure to **Line Up** the **Hole** on the **Pole Assembly Base** with the corresponding **Hole** on the **Adhesive Side** of the **Base Cushion**. Affix the **Base cushion** to the **Pole Assembly Base** by applying **Pressure** for a few seconds for the **Adhesive** to set.
3. Position the **Pole Base** over the **Grommet Hole**.
4. Insert the **Hand Knob** through the **Grommet Hole** and into the **Pole Base**. Turn the **Hand Knob** to **Tighten** it. (Figure 7)

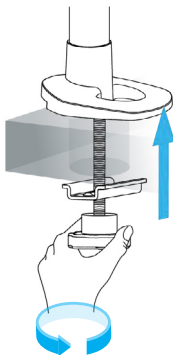

Figure 7

Convert from Grommet Mount to Desk Mount (Optional)

If the Desk Clamp needs to be converted from Grommet Mount to Desk Clamp, follow the steps below.

1. Screw-in the **Hand Knob** through the **Hole** on the **Desk Clamp**. (Figure 8)

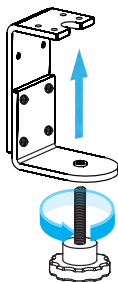

Figure 8

2. Install the **Screw** through the **Washer**, **Clamping Plate**, **Washer** and onto the **Hand Knob**. Use a **Phillips Head Screwdriver** to tighten the **Screw**. (Figure 9)

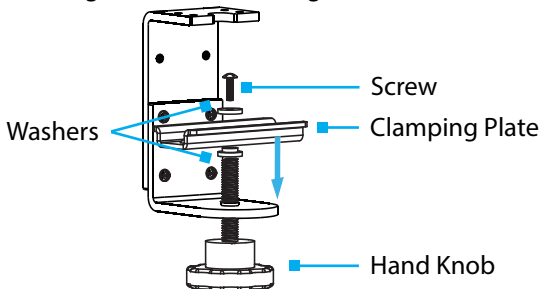

Figure 9

Adjust the Desk Clamp for Different Desk Thicknesses (Optional)

Depending on the thickness of the Desk, use the Top and Mid Screw Holes (default) or the Mid and Bottom Screw holes on the Desk Clamp. The Desk thickness range is ~ 0.8 to 4.3in (20 to 110mm).

1. Remove the **Screws** (x4) from the two halves of the **Desk Clamp** using a **Phillips Head Screwdriver**. (Figure 10)

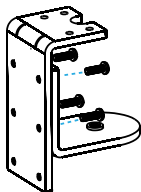

Figure 10

2. Insert the **Screws** (x4) into the **Mid** and **Lower Screw Holes** of the **Desk Clamp**. Use a **Phillips Head Screwdriver** to **Tighten** the **Screws** (x4). (Figure 11)

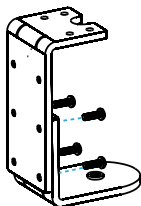

Figure 11

Attach the Monitor Arms

1. Pull the **Lever** and turn the **Knob** on the **Cable Management Clip** to loose the tension. (Figure 12)

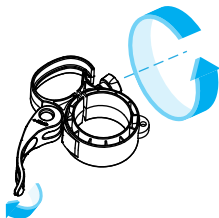

Figure 12

2. Slide the **Cable Management Clip** along the **Pole** to the desired height. (Figure 13)

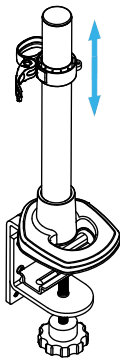

Figure 13

3. Turn the **Knob** to tighten the **Cable Management Clip** and **Push** the **Lever** to be **Fully Closed** to affix it onto the **Pole**. (Figure 14)

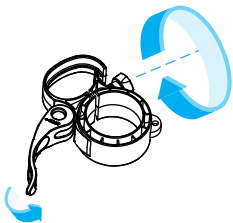

Figure 14

4. Slide the **Swivel Arm** down the **Pole** until it's sitting on top of the **Cable Management Clip**. The **Hex Key** can be stored on the **Cable Management Clip**. (Figure 15).

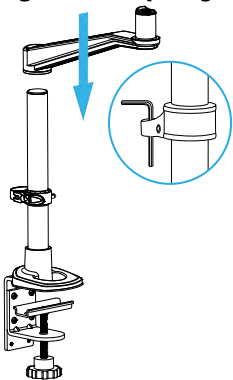

Figure 15

5. Slide the **Spring Arm** onto the **Spring Arm, Mounting Post** until snaps into place. (Figure 16)

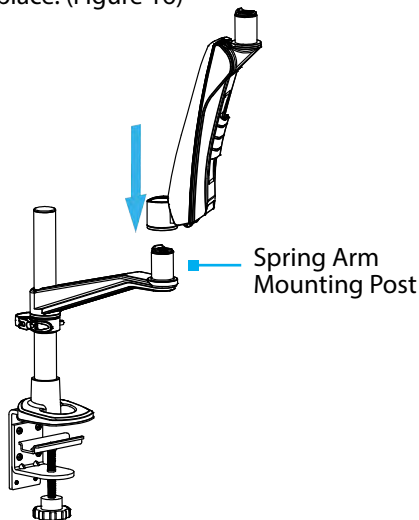

Figure 16

Attach the Monitor

Warnings!

Ensure the weight of the Monitor does not exceed the weight capacity of this product. Exceeding the weight capacity, it may result in personal injury and/or damage to the product, the attached equipment, and/or the mounting surface. This product can support the following weight: Up to 19.8 lb (9 kg).

Attaching the Monitor is a two-person Job. Do not attempt to complete this task by yourself.

The attached monitor may not be properly supported by the display arm until its spring mechanism is correctly adjusted. This may result in the monitor falling rapidly in some cases.

To avoid personally injury and/or equipment damage, always exercise caution when releasing the display by manually support its weight until a stable position is achieved.

1. Carefully place the **Monitor** face down on a protective/soft surface with the **VESA Mounting Points** facing up.
2. Insert the **Monitor Thumbscrews** (x4) through the **VESA Mount Bracket**, and onto the back of the **Monitor**. (Figure 17)

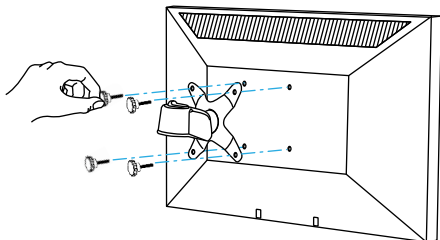

Figure 17

3. Slide the **VESA Mount Bracket** onto the **VESA Mount Bracket Mounting Post**. (Figure 18)

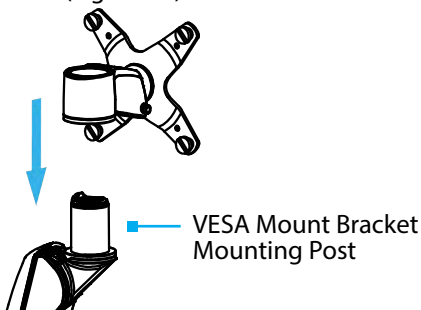

Figure 18

Note: To remove the Monitor, slide and hold the Release Button on top of the Vesa Mount Bracket Mounting Post while detaching the VESA Monitor Mount.

Operation

Adjust the Swivel and Tilt Tension

If the VESA Mount Bracket or the Spring Arm are not holding their position, or if the joints are stiff, adjust the tension.

Adjust the Swivel Tension

1. Use the **Hex Key** to **Loosen** or **Tighten** the **Tension Adjustment Screw(s)**. (Figure 19)

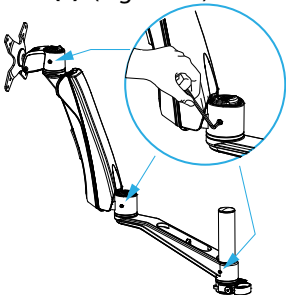

Figure 19

Adjust the Tilt Adjust the Spring Arm

1. While **Supporting** the weight of the **Monitor**, use the **Hex Key** to turn the **Tension Adjustment Screw** on the **Spring Arm**. Turn **Counterclockwise** to **Increase** the **Tension** for **Heavier Monitors**, or turn **Clockwise** to **Decrease** the **Tension** for **Lighter Monitors**. (Figure 20)

Note: *The Monitor should keep its position if the tension is correctly adjusted.*

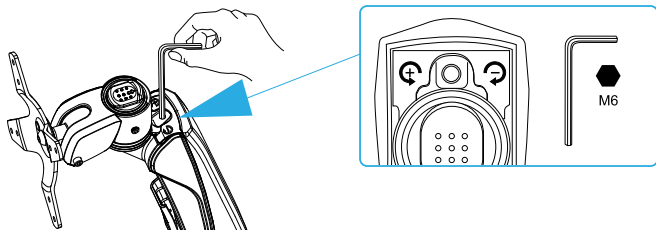

Figure 20

VESA Mount Bracket

1. While **Supporting** the weight of the **Monitor**, use the **Hex Key** to **Loosen** or **Tighten** the **Tension Adjustment Screw**. (Figure 21)

Note: *The Monitor should keep its position if the tension is correctly adjusted.*

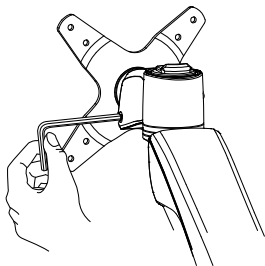

Figure 21

Cable Management

1. Route the **Cable(s)** through the **Cable Management Channel** on the underside of the **Spring Arm**. Guide the **Cable(s)** through the **Cable Management Openings** on the **Swivel Arm**.
2. Route the **Cable(s) Through** the **Cable Management Clip** at the back of the **Pole**. (Figure 22)

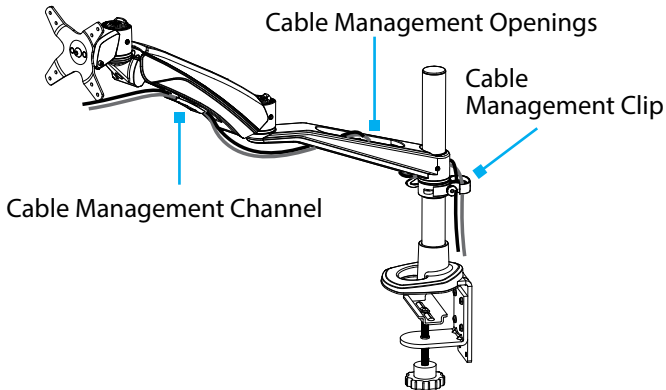

Figure 22

Warranty Information

This product is backed by a ten-year warranty.

For further information on product warranty terms and conditions, please refer to www.startech.com/warranty.

Limitation of Liability

In no event shall the liability of StarTech.com Ltd. and StarTech.com USA LLP (or their officers, directors, employees or agents) for any damages (whether direct or indirect, special, punitive, incidental, consequential, or otherwise), loss of profits, loss of business, or any pecuniary loss, arising out of or related to the use of the product exceed the actual price paid for the product.

Some states do not allow the exclusion or limitation of incidental or consequential damages. If such laws apply, the limitations or exclusions contained in this statement may not apply to you.

Hard-to-find made easy. At StarTech.com, that isn't a slogan. It's a promise.

StarTech.com is your one-stop source for every connectivity part you need. From the latest technology to legacy products — and all the parts that bridge the old and new — we can help you find the parts that connect your solutions.

We make it easy to locate the parts, and we quickly deliver them wherever they need to go. Just talk to one of our tech advisors or visit our website. You'll be connected to the products you need in no time.

Visit www.startech.com for complete information on all StarTech.com products and to access exclusive resources and time-saving tools.

StarTech.com is an ISO 9001 registered manufacturer of connectivity and technology parts since 1985 with operations around the world.

Reviews

Share your experiences using StarTech.com products, including product applications and setup, what you love about the products, and areas for improvement.

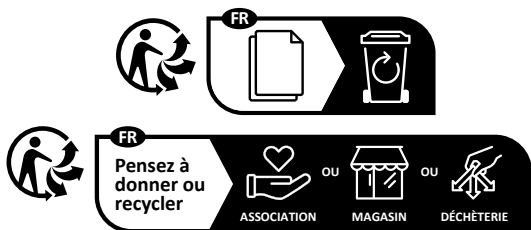

www.quefairedemesdechets.fr

StarTech.com Ltd.

45 Artisans Crescent
London, Ontario
N5V 5E9
Canada

StarTech.com LLP

4490 South Hamilton
Road
Groveport, Ohio
43125
U.S.A.

StarTech.com Ltd.

Unit B, Pinnacle 15
Gowerton Road
Brackmills,
Northampton
NN4 7BW
United Kingdom

StarTech.com Ltd.

Siriusdreef 17-27
2132 WT Hoofddorp
The Netherlands

FR: fr.startech.com

ES: es.startech.com

IT: it.startech.com

DE: de.startech.com

NL: nl.startech.com

JP: jp.startech.com

To view manuals, videos, drivers, downloads, technical drawings, and more visit www.startech.com/support