

# SCREENS

DESKTOP, FLOOR STANDING & PRIVATE WORKING

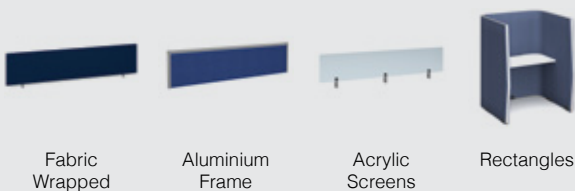

## STYLES



## SPECIFICATION



Product guarantee



Designed & manufactured



**Screens** allow employees to be more focused on their work by helping to cut out colleagues' distracting telephone or computer sounds, in addition to improving office acoustics. Free standing floor screens provide visual, physical and acoustic barriers in any workspace by separating parts of the office into teams and groups or creating quiet work zones and breakout areas in open plan spaces.



## FABRIC FINISHES

(Selected products)



Blue  
(B)



Charcoal  
(C)



Made-to-order

# SCREENS

FABRIC WRAPPED STRAIGHT DESK SCREENS



Whether dividing desk space or an entire office area, office screens provide an element of privacy for employees, allowing them to be comfortable while they work.

Our fabric straight desktop screens are a cost effective way of dividing desk clusters and are supplied with brackets to fit all 25mm desktops. A universal bracket is available as an optional extra to mount screens to different manufacturer's desks.

30mm thick with a layer of foam between outer fabric and melamine core

Combines a slim profile with a robust and durable construction

Desk mounted screens use standard desk brackets which come as standard

When using as a return screen order ESRB (see page 138)



CODE	W	D	H	STOCKED	Band A	Band B	Band C	Band D	Band E
ES800S	800	30	400	£149	£165	£179	£209	£225	£243
ES1000S	1000	30	400	£165	£179	£194	£224	£241	£261
ES1200S	1200	30	400	£173	£189	£205	£236	£255	£275
ES1400S	1400	30	400	£193	£208	£222	£252	£271	£293
ES1600S	1600	30	400	£202	£215	£229	£261	£281	£304
ES1800S	1800	30	400	£209	£222	£239	£266	£286	£310

STOCKED



Blue (B)



Charcoal (C)

3-4 week lead time

MTO



Supplied with standard brackets for straight desks only. For additional brackets see pages [PAGE 138](#)-[PAGE 139](#)

Please add fabric colour finish when ordering eg. ES1600S in Charcoal = ES1600S-C

# SCREENS

FABRIC WRAPPED WAVE DESK SCREENS



Whether dividing desk space or an entire office area, office screens provide an element of privacy for employees, allowing them to be comfortable while they work. Our fabric wave desktop screens are ideal for use with wave desktops and are supplied with brackets to fit all 25mm desktops. A universal bracket is available as an optional extra to mount screens to different manufacturer's desks.

30mm thick with a layer of foam between outer fabric and melamine core

Combines a slim profile with a robust and durable construction

Desk mounted screens use standard desk brackets which come as standard

When using as a return screen order ESRB (see page 138)



CODE	W	D	H	STOCKED	Band A	Band B	Band C	Band D	Band E
ES800W	800	30	200-400	£158	£172	£187	£216	£233	£252
ES1000W	1000	30	200-400	£173	£189	£205	£236	£255	£275
ES1200W	1200	30	200-400	£193	£208	£222	£252	£271	£293
ES1400W	1400	30	200-400	£202	£215	£229	£261	£281	£304
ES1600W	1600	30	200-400	£209	£222	£239	£266	£286	£310
ES1800W	1800	30	200-400	£216	£229	£245	£275	£296	£320

STOCKED



Blue  
(B)



Charcoal  
(C)

3-4 week  
lead time

MTO 1



Supplied with standard brackets for straight desks only. For additional brackets see pages **PAGE 138-PAGE 139**

Please add fabric colour finish when ordering eg. **ES1600W** in Charcoal = **ES1600W-C**

# SCREENS

ALUMINIUM FRAME FABRIC DESK SCREENS



Aluminium frame screens are an excellent addition to any modern desk and office furniture to provide a degree of privacy to desks which are in close proximity to others. Frames are available in silver, white and black so you can synchronise with the desk legs, with matching brackets that fit to the back of desks or desk returns. Fabric screens are stocked in blue with made to order fabric options.

30mm thick with robust aluminium frames for additional stability

Fully upholstered fabric screens that offer a level of increased privacy

Available for all size desks with additional screen size for the desk returns

Brackets available in black, silver and white to match frames

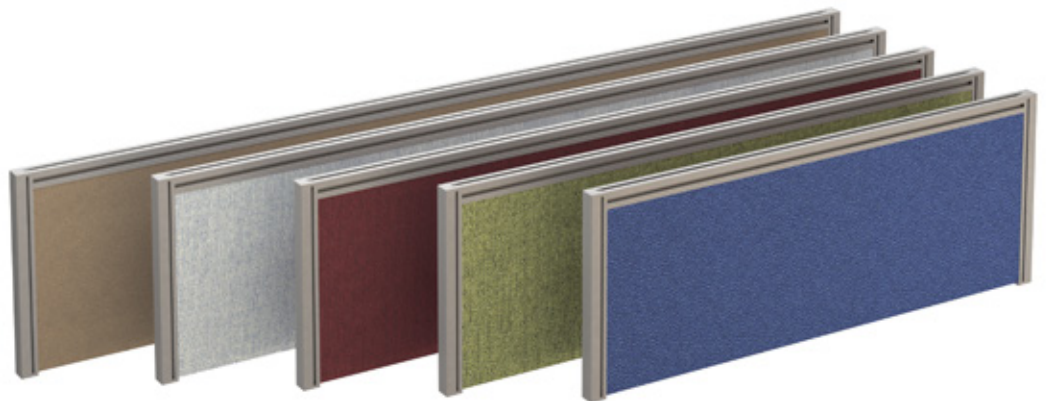

CODE	W	D	H	STOCKED	Band A	Band B	Band C	Band D	Band E
A785*	785	30	380	n/a	£198	£227	£270	£291	£315
A1000	1000	30	380	n/a	£211	£270	£298	£321	£347
A1200	1200	30	380	£224	£226	£287	£310	£333	£360
A1400	1400	30	380	£239	£241	£291	£332	£358	£387
A1600	1600	30	380	£273	£275	£319	£359	£387	£419
A1800	1800	30	380	£291	£295	£341	£375	£405	£437

## FRAME COLOURS

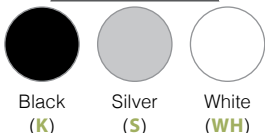

## STOCKED



## MTO

3-4 week lead time



Supplied without brackets. See pages **PAGE 138-PAGE 139** for brackets to be ordered separately

\* A785 suitable for 800mm return desks

Please add frame colour followed by fabric colour when ordering eg. A1600 with Silver frame in Blue = A1600-S-B

# SCREENS

ALUMINIUM FRAME GLAZED DESK SCREENS



Aluminium frame screens are an excellent addition for any modern desk to provide a degree of privacy for employees who are situated in close proximity to others. Frames are available in silver, white and black so you can synchronise with the desk legs and the semi-transparent glazed screens are a stylish addition which allow light to flow through the room whilst tackling the issue of ambient noise.

30mm thick with robust aluminium frames for additional stability

Glazed semi-transparent perspex screens that offer a level of increased privacy

Ideal for use on bench desks with additional brackets available for runs of desks

Brackets available in black, silver and white to match frames

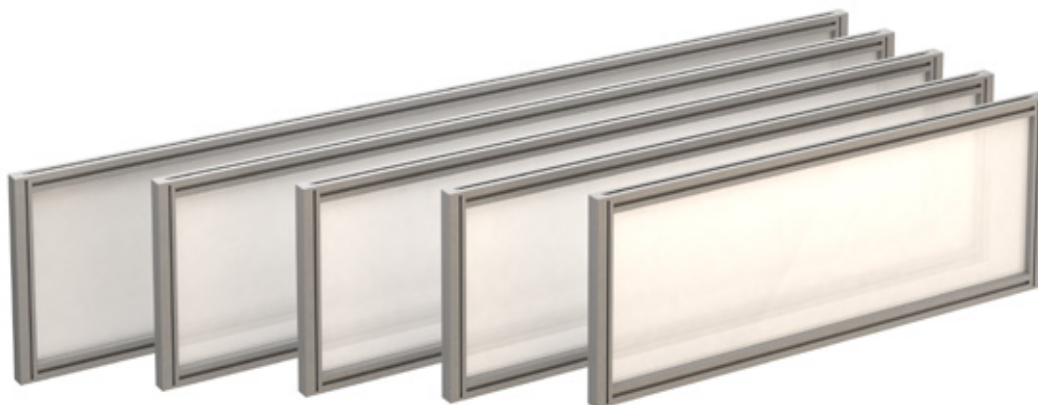

CODE	W	D	H	STOCKED
AG1000	1000	30	380	£263
AG1200	1200	30	380	£287
AG1400	1400	30	380	£304
AG1600	1600	30	380	£334
AG1800	1800	30	380	£375

## FRAME COLOURS

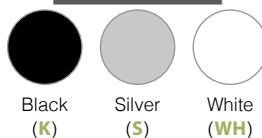

Black (K) Silver (S) White (WH)

## STOCKED



Polar White (W)

Supplied without brackets. See pages **PAGE 138-PAGE 139** for brackets to be ordered separately

Please add frame colour followed by glaze colour when ordering eg. **AG1600** with Silver frame in White = **AG1600-S-W**

# SCREENS

VIBE DESKTOP SCREENS



Vibe is a range of made-to-order, designer office screens, available in a multitude of fabric colour options. Vibe screens combine a slim profile with a robust and durable construction to improve the layout and function of any office and they are ideal for use with bench desking with the modern trend of having screens shorter than the desk length, with universal desk brackets that come as standard.

35mm thick with an additional foam layer between outer fabric and MFC core

Made to order, designer desktop screens which are elegant, modern and stylish

Hand crafted, exposing the edge of the stitch detail on a radius corner

Versatile office desk partitions to help provide physical and acoustic barriers



CODE	W	D	H	Band A	Band B	Band C	Band D	Band E
VB800	800	35	400	£183	£194	£224	£241	£261
VB1000	1000	35	400	£194	£211	£241	£260	£280
VB1200	1200	35	400	£208	£222	£252	£271	£293
VB1400	1400	35	400	£223	£240	£268	£288	£313
VB1600	1600	35	400	£233	£247	£277	£298	£322
VB1800	1800	35	400	£240	£256	£285	£307	£332

MTO

3-4 week lead time



Supplied with standard brackets for straight desks only. For additional brackets see pages **PAGE 138-PAGE 139**

# SCREENS

ACRYLIC SCREEN TOPPERS



Acrylic screen toppers have been designed as an add-on to existing fabric or aluminium frame desktop screens to quickly, easily and at minimal cost convert your existing screen into a barrier screen. The use of acrylic not only allows light to pass through the office but work colleagues can also see each other, plus the additional 300mm of increased height is a solution to help keep employees safe.

Add-on top of existing screens with universal brackets supplied

Suitable for use with all screen widths  
15-30mm depth

Provide cough and sneeze barriers between employees to help stop germs spreading

5mm thick acrylic topper to still allow visibility between colleagues

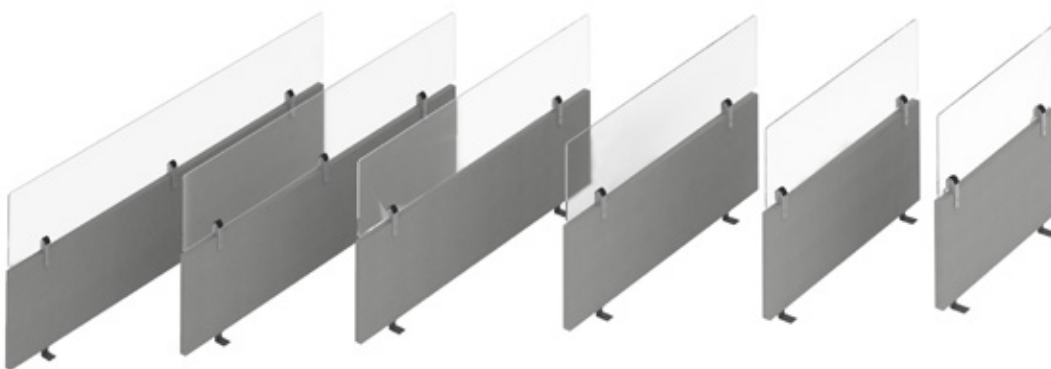

Base screens not included

CODE	W	D	H	MTO
SE800-CA	800	5	300	£228
SE1000-CA	1000	5	300	£248
SE1200-CA	1200	5	300	£270
SE1400-CA	1400	5	300	£290
SE1600-CA	1600	5	300	£336
SE1800-CA	1800	5	300	£437

## BRACKET COLOURS



Black  
(K)



Silver  
(S)



White  
(WH)

4 week  
lead time

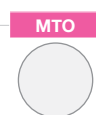

5mm clear  
acrylic

Please add bracket colour when ordering eg. SE800-CA with Silver brackets = SE800-CA-S



# SCREENS

FABRIC WRAPPED FLOOR SCREENS



Free standing floor screens are available in three different heights and are used to break up the appearance and divide the space without losing any of the benefits of the open plan layout. Fabric wrapped floor screens also provide the operators with an element of seclusion and privacy and can be joined with the linking strips for connecting 2 screens or 4 screens together.

40mm thick with an additional foam layer between outer fabric and MFC core

Available in 1200mm, 1500mm and 1800mm heights

Screens can utilise the desk as support or can be used with bar feet supplied

2 panel linking strips for connecting screens together (see next page)



CODE	W	D	H	STOCKED	Band A	Band B	Band C
208	800	40	1200	n/a	£236	£265	£314
210	1000	40	1200	n/a	£236	£265	£314
212	1200	40	1200	n/a	£250	£279	£328
214	1400	40	1200	n/a	£250	£279	£328
216	1600	40	1200	n/a	£266	£297	£359
218	1800	40	1200	n/a	£284	£315	£373

CODE	W	D	H	STOCKED	Band A	Band B	Band C
508	800	40	1500	n/a	£239	£268	£314
510	1000	40	1500	n/a	£253	£284	£328
512	1200	40	1500	£275	£284	£315	£373
514	1400	40	1500	n/a	£294	£325	£383
516	1600	40	1500	£290	£310	£338	£402
518	1800	40	1500	£319	£330	£361	£418

CODE	W	D	H	STOCKED	Band A	Band B	Band C
808	800	40	1800	n/a	£284	£315	£373
810	1000	40	1800	n/a	£284	£315	£373
812	1200	40	1800	£319	£330	£361	£418
814	1400	40	1800	£319	£330	£361	£418
816	1600	40	1800	£334	£337	£370	£426

STOCKED



Blue (B)



Charcoal (C)

3 week lead time



MTO

Please add fabric colour finish when ordering eg. 816 in Blue = 816-B

## Designer Screen Feet



CODE	Description	RRP
<b>VFT1</b>	Screen feet (pair)	<b>£71</b>

- For use with floor standing screens
- Designer screen feet for floor standing screens

## Floor Screen Linking Strips



CODE	Description	RRP
<b>LK22</b>	1200mm 2-2 Strip	<b>£22</b>
<b>LK25</b>	1500mm 2-2 Strip	<b>£23</b>
<b>LK28</b>	1800mm 2-2 Strip	<b>£24</b>

- Links floor standing fabric screens
- For connecting 2 screens together

## Floor Screen Linking Strips

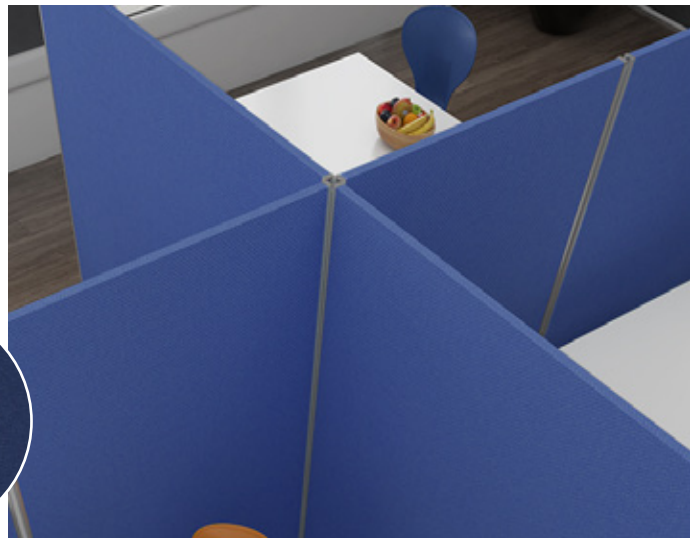

CODE	Description	RRP
<b>LK42</b>	1200mm 4-4 Strip	<b>£31</b>
<b>LK45</b>	1500mm 4-4 Strip	<b>£35</b>
<b>LK48</b>	1800mm 4-4 Strip	<b>£38</b>

- Links floor standing fabric screens
- For connecting 4 screens together



Silver  
(SL)



White  
(WH)

Please add foot colour when ordering eg. **VFT1** in Silver = **VFT1-SL**

# SCREENS

ACCESSORIES & BRACKETS

## Universal Desktop Screen Brackets

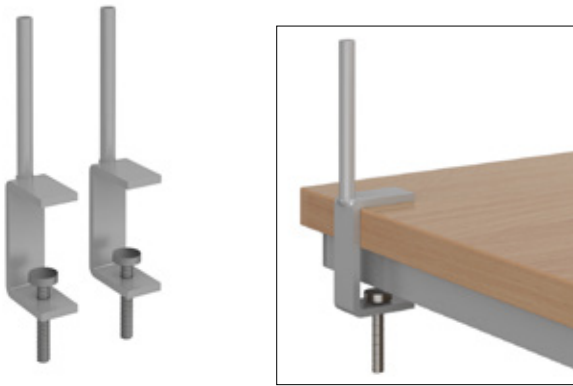

CODE	Description	RRP
<b>UNSCBR</b>	Universal bracket (pair)	<b>£33</b>

- Clamps between 15mm-50mm desktops
- For use on all non-aluminium fabric desk screens

## Desk Return Brackets

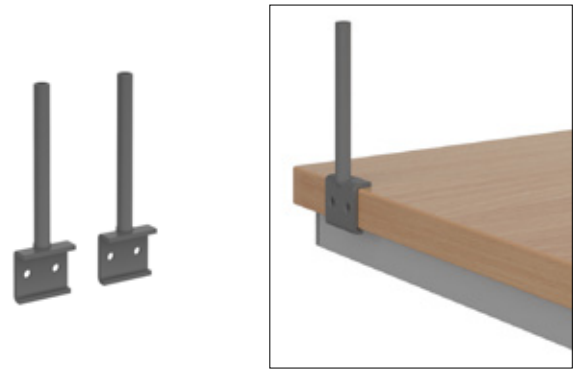

CODE	Description	RRP
<b>ESRB</b>	Return bracket (pair)	<b>£31</b>

- Used to attach desks to return sides of desks
- For use on all non-aluminium fabric desk screens

## Aluminium Frame Fabric Screen Brackets



CODE	Description	RRP
<b>AFSBK</b>	For fabric screens	<b>£57</b>

- Clamps to standard desktops
- Used on single desks or runs of single desks

## Aluminium Frame Glazed Screen Brackets



CODE	Description	RRP
<b>AGSBK</b>	For glazed screens	<b>£69</b>

- Clamps to standard desktops
- Used on single desks or runs of single desks

## Adapt & Fuze Back-To-Back Desk Brackets

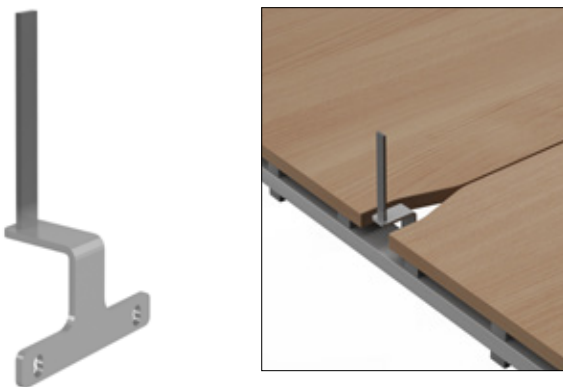

CODE	Description	RRP
<b>EDELSB</b>	End bracket	<b>£41</b>

- Bolts directly to under frame of desk
- Used on Adapt and Fuze bench desks

## Adapt & Fuze Back-To-Back Desk Brackets

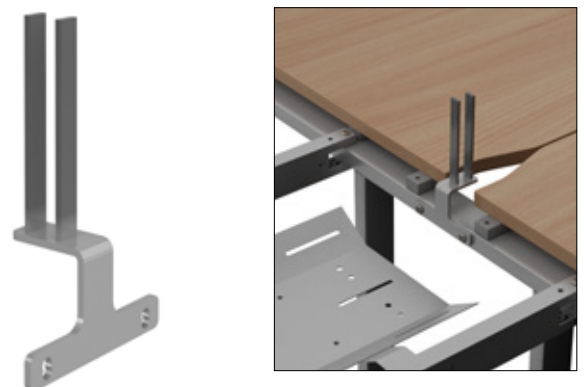

CODE	Description	RRP
<b>EDILSB</b>	Intermediate bracket	<b>£48</b>

- Bolts directly to under frame of desk
- Used on Adapt and Fuze bench desks



Black  
(K)



Silver  
(S)



White  
(WH)

Please add finish when ordering  
eg. **AFSBK** in silver = **AFSBK-S**

## Aluminium Frame Screen Brackets



CODE	Description	RRP
<b>ARBK</b>	For the back of desks, pack of 2	<b>£65</b>

- Screw clamps to fit all desks
- Fix to the back of desks

## Aluminium Frame Screen Return Brackets

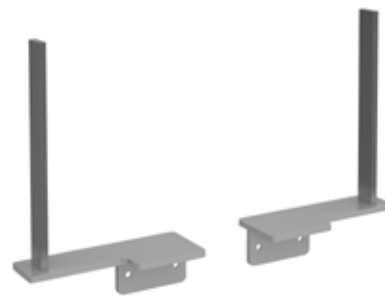

CODE	Description	RRP
<b>ASBK</b>	For desk return, pack of 2	<b>£65</b>

- Screw clamps to fit all desks
- Fix to the back of desks

## Aluminium Frame Return Screen Brackets for Mid Runs

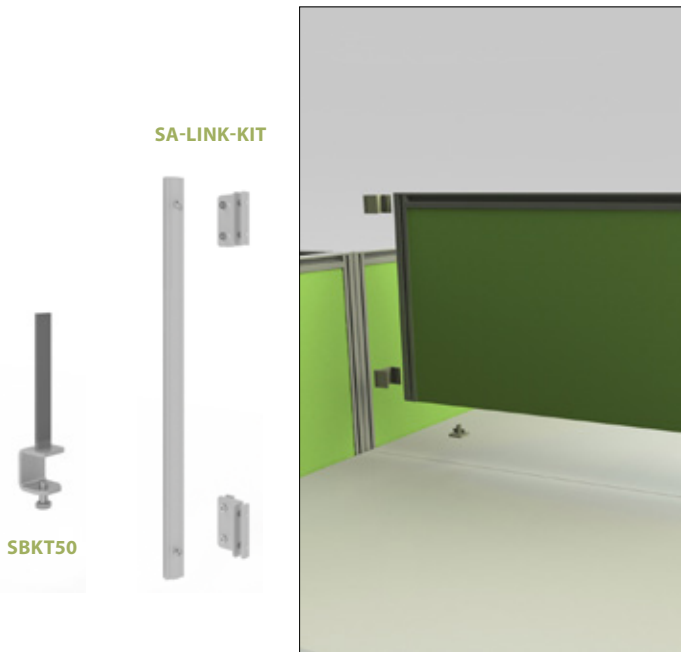

CODE	Description	RRP
<b>SBKT50</b>	Screen mid run brackets	<b>£34</b>
<b>SA-LINK-KIT</b>	Screen linking kit	<b>£34</b>

- SBKT50 - Front mounting screen bracket
- SA-LINK-KIT - Rear mounting screen connector to rear desktop screens

## Acrylic Screen Topper Brackets

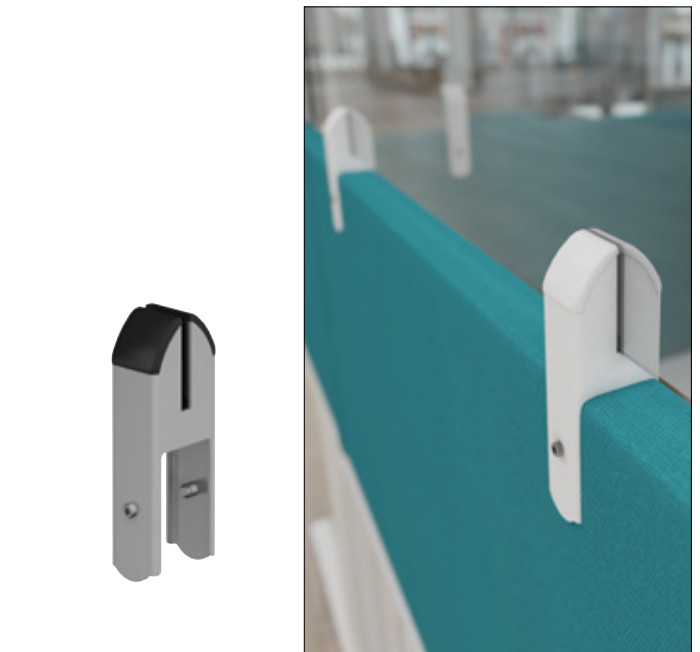

CODE	Description	RRP
<b>AHSB-SE</b>	Screen topper bracket (single)	<b>£41</b>

- For use with acrylic screen topper, 300mm high
- For screen widths 18-30mm wide



Please add finish when ordering  
 eg. **AHSB-FS** in silver = **AHSB-FS-S**  
 (**SBKT50** and **SA-LINK-KIT** available in silver only)

# SCREENS

SCREEN MATRIX

Product	Rear Screens							Return Screens			
	Vibe Elev8 <sup>2</sup> Single (1000/1200/1400/1600)	Vibe Elev8 <sup>2</sup> B2B (1200/1400/1600)	Vibe Desktop (800/1000/1200/1400/1600/1800)	Aluminium Fabric (800/1000/1200/1400/1600/1800)	Aluminium Glazed (800/1000/1200/1400/1600/1800)	Fabric Straight (800/1000/1200/1400/1600/1800)	Fabric Wave (800/1000/1200/1400/1600/1800)	Aluminium Fabric (785)	Aluminium Glazed (785)	Fabric Straight (800/1000/1200)	Fabric Wave (800/1000/1200)
<b>Elev8<sup>2</sup></b> Single desks	✓ Bracket SUPPLIED		✓ Bracket SUPPLIED	✓ Order ARBK	✓ Order ARBK	✓ Bracket SUPPLIED	✓ Bracket SUPPLIED	✓ Order ASBK	✓ Order ASBK	✓ Order ESRB	✓ Order ESRB
<b>Elev8<sup>2</sup></b> Back-to-back desks		✓ Bracket SUPPLIED									
<b>Adapt II</b> Single desks	✓ Bracket SUPPLIED		✓ Bracket SUPPLIED	✓ Order AFSBK	✓ Order AGSBK	✓ Bracket SUPPLIED	✓ Bracket SUPPLIED	✓ Order ASBK	✓ Order ASBK	✓ Order ESRB	✓ Order ESRB
<b>Adapt II</b> Back-to-back desks			✓ Bracket SUPPLIED	✓ Bracket EDELSB/ EDILSB	✓ Bracket EDELSB/ EDILSB	✓ Bracket SUPPLIED	✓ Bracket SUPPLIED	✓*∞ Order ASBK	✓*∞ Order ASBK		
<b>Fuze</b> Single desks	✓ Bracket SUPPLIED		✓ Bracket SUPPLIED	✓ Order AFSBK	✓ Order AGSBK	✓ Bracket SUPPLIED	✓ Bracket SUPPLIED	✓ Order ASBK	✓ Order ASBK	✓ Order ESRB	✓ Order ESRB
<b>Fuze</b> Back-to-back desks			✓ Bracket SUPPLIED	✓ Bracket EDELSB/ EDILSB	✓ Bracket EDELSB/ EDILSB	✓ Bracket SUPPLIED	✓ Bracket SUPPLIED	✓* Order ASBK	✓* Order ASBK		
<b>Connex</b> Single desks	✓ Bracket SUPPLIED		✓ Bracket SUPPLIED	✓ Order ARBK	✓ Order ARBK	✓ Bracket SUPPLIED	✓ Bracket SUPPLIED	✓* Order ASBK	✓* Order ASBK		
<b>Connex</b> Back-to-back desks			✓ Bracket SUPPLIED	✓ Order ARBK	✓ Order ARBK	✓ Bracket SUPPLIED	✓ Bracket SUPPLIED	✓* Order ASBK	✓* Order ASBK		
<b>TR10</b> Desks	✓ Bracket SUPPLIED		✓ Bracket SUPPLIED	✓ Order ARBK	✓ Order ARBK	✓ Bracket SUPPLIED	✓ Bracket SUPPLIED	✓† Order ASBK	✓† Order ASBK	✓† Order ESRB	✓† Order ESRB
<b>Vivo</b> Desks			✓ Bracket SUPPLIED	✓ Order ARBK	✓ Order ARBK	✓ Bracket SUPPLIED	✓ Bracket SUPPLIED	✓† Order ASBK	✓† Order ASBK	✓† Order ESRB	✓† Order ESRB
<b>Maestro 25</b> Desks			✓ Bracket SUPPLIED	✓ Order ARBK	✓ Order ARBK	✓ Bracket SUPPLIED	✓ Bracket SUPPLIED	✓† Order ASBK	✓† Order ASBK	✓† Order ESRB	✓† Order ESRB
<b>Contract 25</b>			✓ Bracket SUPPLIED	✓ Order ARBK	✓ Order ARBK	✓ Bracket SUPPLIED	✓ Bracket SUPPLIED	✓ Order ASBK	✓ Order ASBK	✓ Order ESRB	✓ Order ESRB

✓ Recommended

✓ Compatible

\* For return screen mid-runs use SBKT50 and SA-LINK-KIT

∞ Return screens not suitable for back-to-back desks with sliding tops

† Return screens not suitable for 600mm straight desks

# SCREENS

FABRICS

Fabrics specified for their acoustic properties are ideal for wall coverings, suspended ceiling panels, desk mounted or free standing screens. The job of the fabric is to allow sound to pass through cleanly, or provide a degree of absorbency, which allows the specialist acoustic system behind to do what it needs to do.

## Stocked

Supplier **Macflex**  
Range **Mac182**

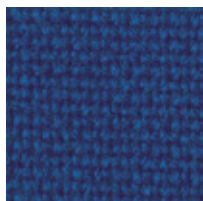

BLUE (B)

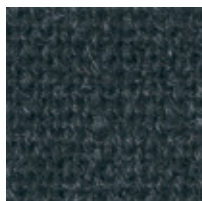

CHARCOAL (C)

## Made to order

Band	Supplier	Range
<b>A</b>	<b>Camira</b>	Cara Carlow
<b>B</b>	<b>Camira</b> <b>Inloom</b>	Era 170 Fiji Bondai 170
<b>C</b>	<b>Camira</b>	Sonus Lucia
<b>D</b>	<b>Camira</b>	Blazer Lite Nexus
<b>E</b>	<b>Camira</b>	Synergy 170

### Camira Cara Band A



EJ186 FAIR ISLE

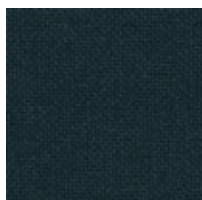

EJ138 BLACK

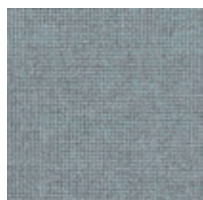

EJ190 HILLSWICK

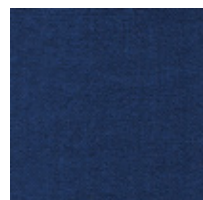

EJ180 CLUANIE



EJ076 PITLOCHRY

### Inloom Bondai 170 Band B

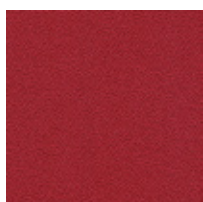

4711

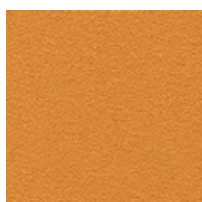

3705

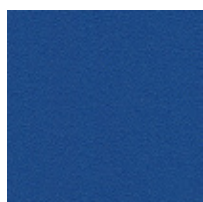

6771

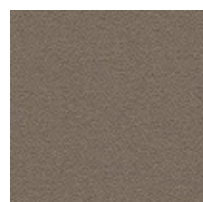

1708



8778

### Camira Lucia Band C



YB097 BLUEBELL



YB156 MADURA

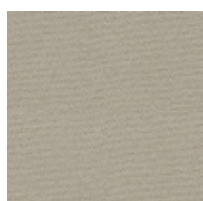

YB093 ARUBA

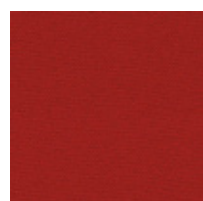

YB106 CALYPSO



YB088 SOLANO

### Camira Blazer Lite Band D

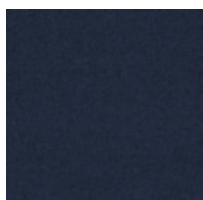

LTH44 MOOD

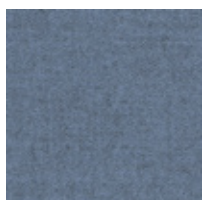

LTH64 DAINTY



LTH55 HAPPY

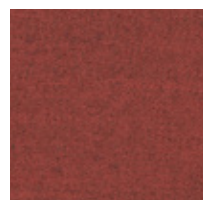

LTH52 ASPIRE



LTH39 RETREAT

### Camira Synergy 170 Band E

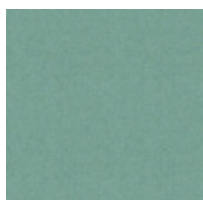

LDP54 REGARD



LDP56 KINSHIP

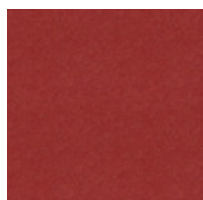

LDP85 SHARE

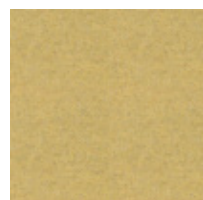

LDP45 SUMMON

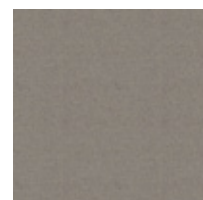

LDP20 LEVEL

All made-to-order screen orders for non-screen fabrics are priced on application.

# PRIVA WORKSTATIONS

PRIVATE WORKING



**SOCIAL  
SPACES**

## RANGE



Rectangles



Angles

## SPECIFICATION



Product  
guarantee



Designed &  
manufactured



Highly relevant in today's modern open plan offices, **Priva workspaces** are designed for those moments where personal space is required to focus on tasks with minimal noise and distraction. The solo booths are a great place for individuals to seek refuge away the busy, hectic office environment by creating a compact, secluded working area which is sometimes needed for a period of intensive work or concentration to finish off the job in hand.



## FABRIC finishes

---



5 weeks  
lead time



# PRIVA

WORKSTATIONS - RECTANGLES



Too much interaction and not enough privacy has become a real issue for employees who need to concentrate or just take a break during the working day. Priva workstations bring a new level of flexibility to the office with versatile, individual cubicles to suit all working styles. Priva Rectangles are high tiered square booths designed to provide a high level of acoustic and visual privacy.

Rectangular workstation pods available in 2 sizes with a study pod ideal for concentrated work

Retreat offering visual and acoustic privacy in open plan office environments

Individual workspaces which can be arranged in a dynamic configuration

Available in two-tone fabrics and ideal for a bustling, busy office by reducing sharp corners



CODE	DESCRIPTION	W	D	H	Band A	Band B	Band C	Band D	Band E
PRV-WS01R	Study rectangular	1200	1500	1500	N/A	N/A	N/A	£3250	£3450
PRV-WS02R-R	Right hand rectangular	1200	1800	1500	N/A	N/A	N/A	£4000	£4200
PRV-WS02R-L	Left hand rectangular	1200	1800	1500	N/A	N/A	N/A	£4000	£4200
PRV-WS03R-R	Right hand large rectangular	1400	2000	1500	N/A	N/A	N/A	£4500	£4700
PRV-WS03R-L	Left hand large rectangular	1400	2000	1500	N/A	N/A	N/A	£4500	£4700

MTO

6 week  
lead time



# PRIVA

WORKSTATIONS - ANGLES



The loss of private space and an inability to concentrate in an open plan work area has inspired the design of the Priva angles workstations which can be configured to specific needs and support individual work zones. The rich repertoire of geometric shapes can be positioned to suit defined spaces, allowing individuals to concentrate and complete focused tasks in a private space within the workplace environment.

Angled workstation pods available in 2 sizes with a study pod ideal for concentrated work

Design can be easily extended with numerous configurations to suit any office layout

Individual workspaces which can offer more enclosed privacy when arranged the right way

Angles workstations break the traditional "square-cube" stereotype and add a fresh look to the office



CODE	DESCRIPTION	W	D	H	Band A	Band B	Band C	Band D	Band E
PRV-WS01A	Study angular	2000	1000	1500	N/A	N/A	N/A	£2900	£3100
PRV-WS02A-R	Right hand hexagonal	1600	1800	1500	N/A	N/A	N/A	£3800	£4000
PRV-WS02A-L	Left hand hexagonal	1600	1800	1500	N/A	N/A	N/A	£3800	£4000
PRV-WS03A-R	Right hand large hexagonal	1800	2000	1500	N/A	N/A	N/A	£4100	£4300
PRV-WS03A-L	Left hand large hexagonal	1800	2000	1500	N/A	N/A	N/A	£4100	£4300

MTO

6 week lead time



# SCREENS

PRIVA SURROUND SCREENS



Priva modular floor screens are designed to be used in dynamic groups as well as repeated in rows of screens. Whether it's a touchdown area, collaborative space, personal workstation or a private office, Priva surround screens make it easy to create unique, inspiring and functional spaces, offering a robust partition solution with black metal feet, making them ideal for absorbing sound in open plan office environments.

Aid concentration, reduce noise pollution and even prevent sickness from spreading

A cost effective solution to maximising space in the office and wider workplace

3 screen systems ideal for a semi-private meeting space, photocopying area or drinks section

Clean modern designs that are easy to assemble and reconfigure when needed



CODE	DESCRIPTION	W	D	H	Band A	Band B	Band C	Band D	Band E
PRV-SQ01	C-shape	2630	2800	1500	N/A	N/A	N/A	£6633	£6837
PRV-SQ02	S-shape	2630	5200	1500	N/A	N/A	N/A	£9949	£10154
PRV-HX01	Half hexagon	3490	2270	1500	N/A	N/A	N/A	£6633	£6837

MTO

5 week lead time



# SCREENS

PRIVA MODULAR SCREENS



Priva modular floor standing screens are not only colourful and modern additions to the office aesthetics, but also deliver a large array of functional design solutions for every work style and preference. Priva screens are robust, visually inspiring and offer great sound absorption, especially in open plan offices where they can help reduce the noise levels associated with teams and departments working in the same large workspace.

Create space division and reduce transfer of pathogens by adding dividers around areas

Design can be easily extended with numerous configurations to suit any office layout

Modular screen can be added in centre of straight sections to create larger runs of screens

Clean, modern design with two-tone fabric trim options to complement any interior



Add straight screens to increase the overall size

CODE	DESCRIPTION	W	D	H	Band A	Band B	Band C	Band D	Band E
PRV-MOD8	Straight modular	800	60	1500	N/A	N/A	N/A	£817	£868
PRV-DL01	Dog leg	2000	580	1500	N/A	N/A	N/A	£3266	£3470
PRV-WV01	Wave	2430	1380	1500	N/A	N/A	N/A	£3266	£3470

MTO

5 week lead time

