

BTTB / BTTC

Boardroom Table - Trumpet Base

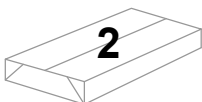

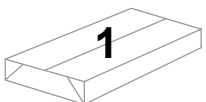

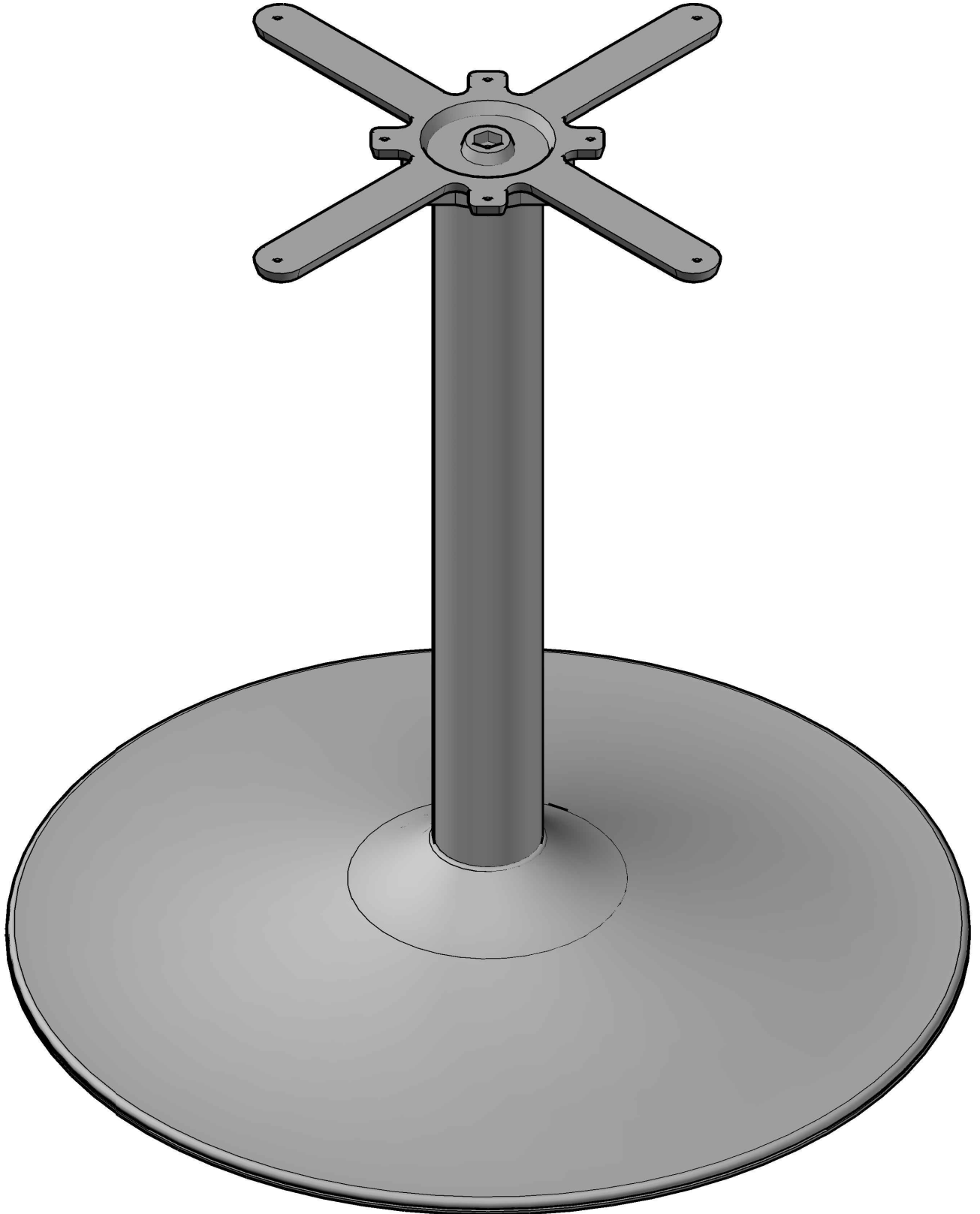
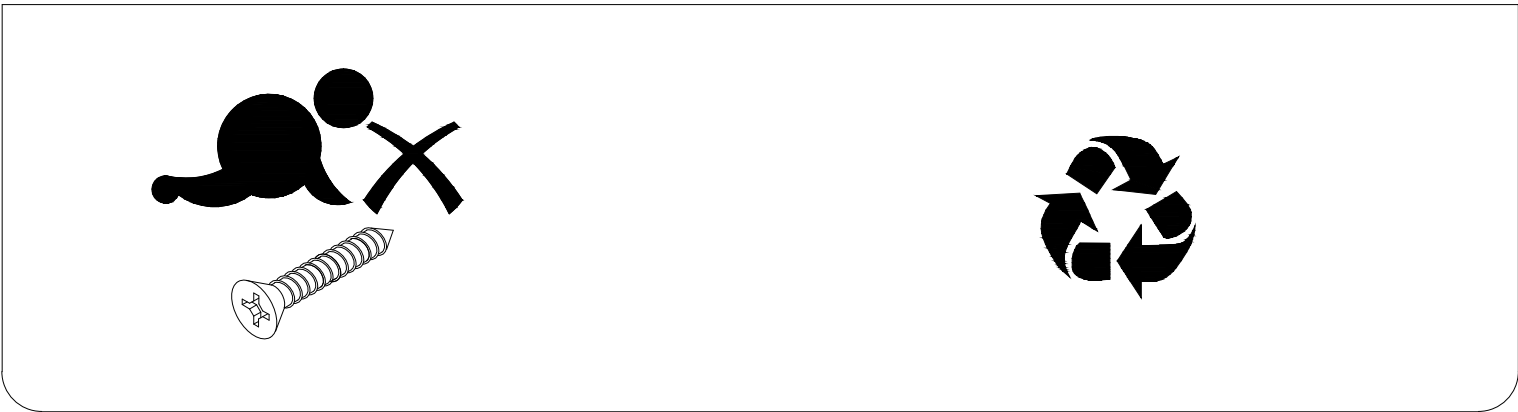
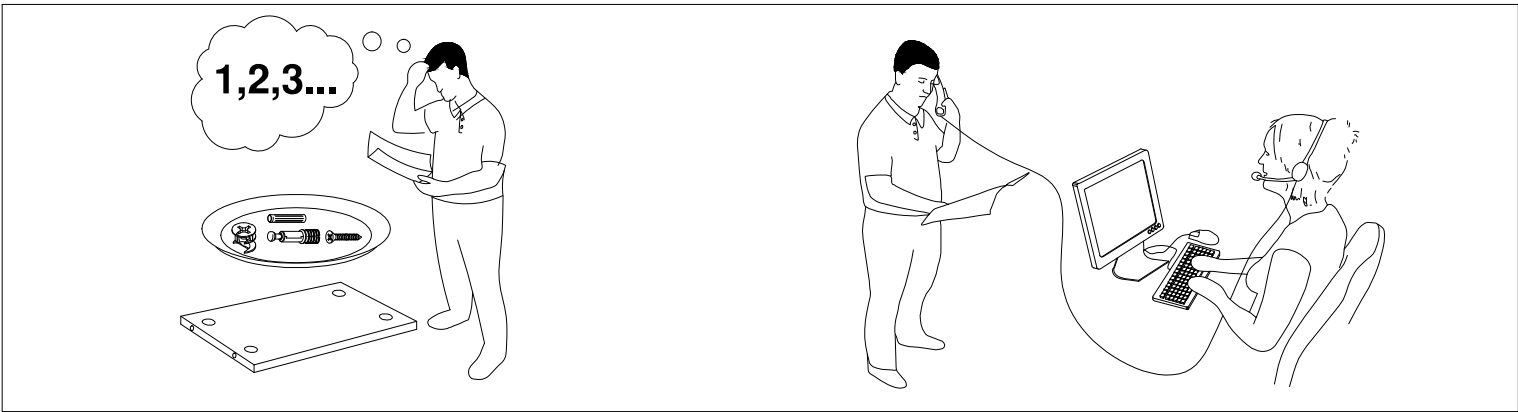
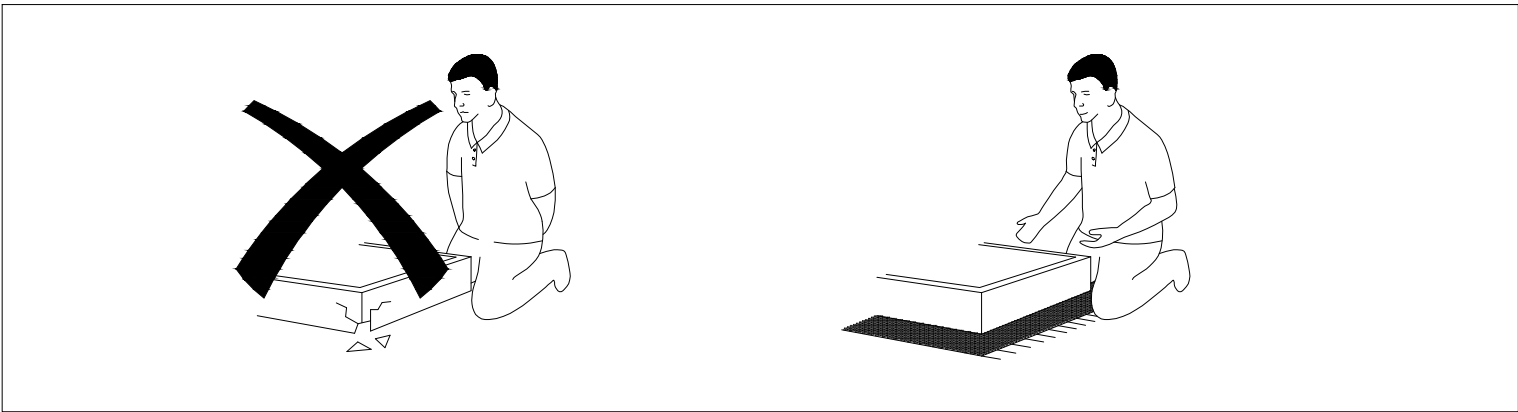
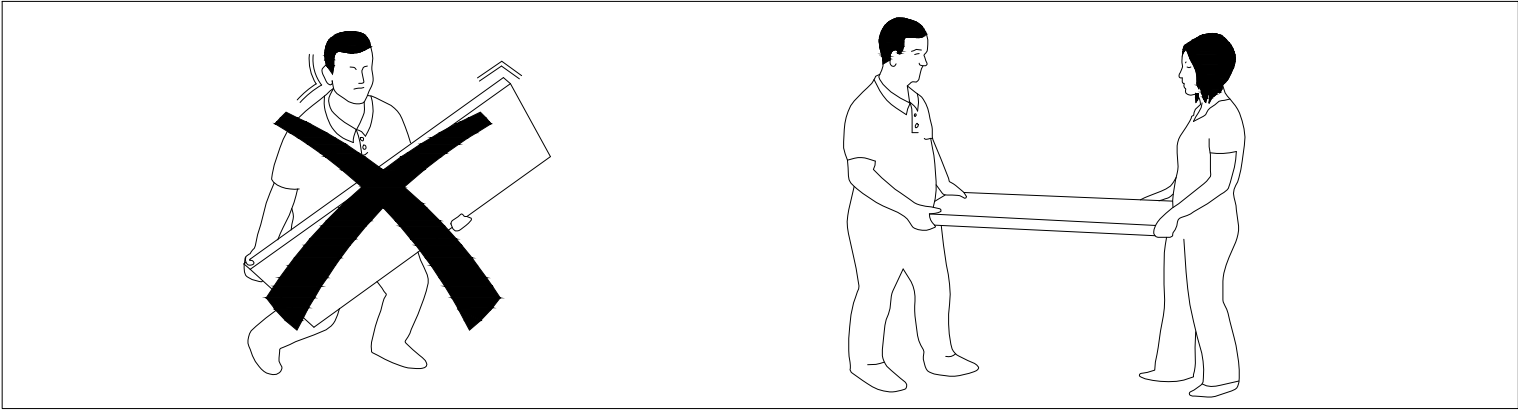
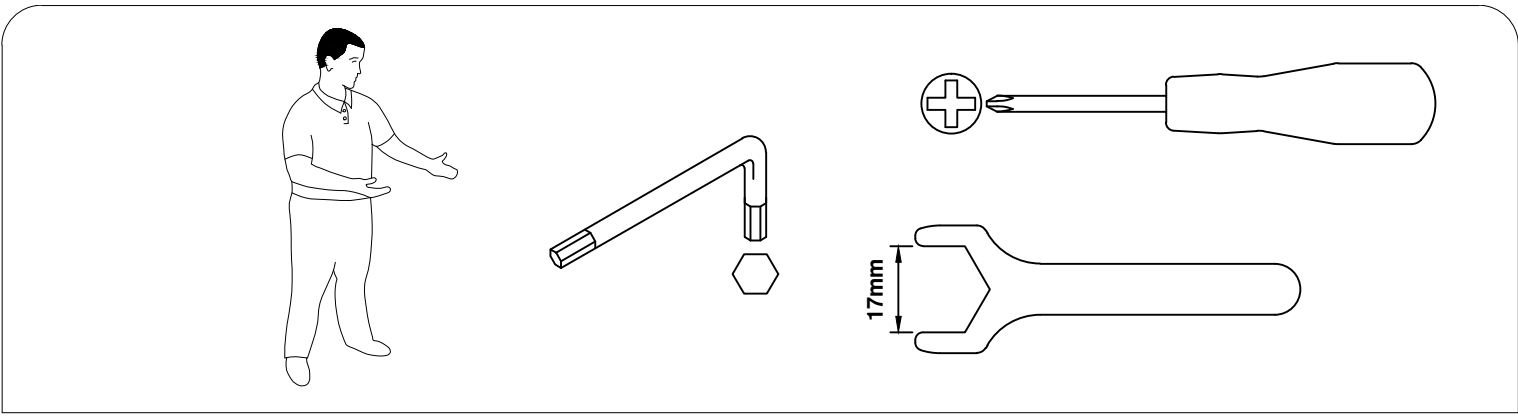

Please check that you have all the fittings

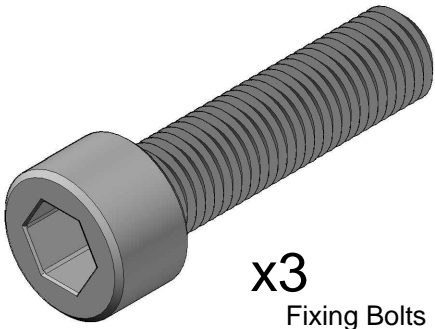

x3
Fixing Bolts

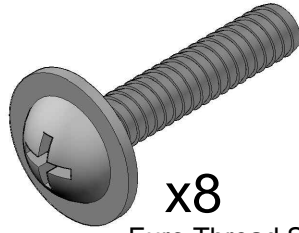

x8
Euro Thread Screws

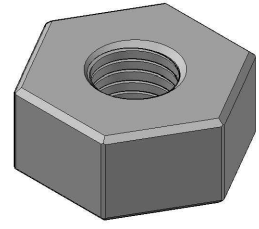

x2
M8 Nuts



x1
M8 Threaded Bar

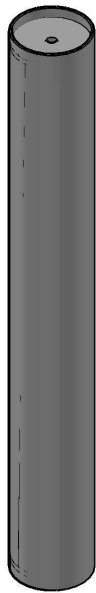

Trumpet Base Column
x1

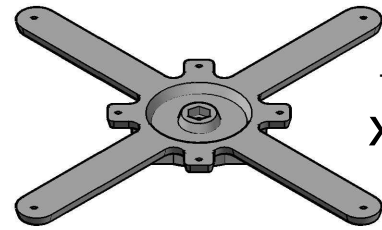

Top Fixing Bracket
x1

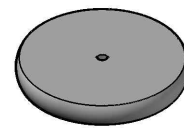

4kg Counter Weight
x1

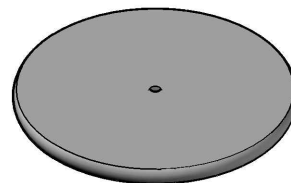

8kg Counter Weight
x1

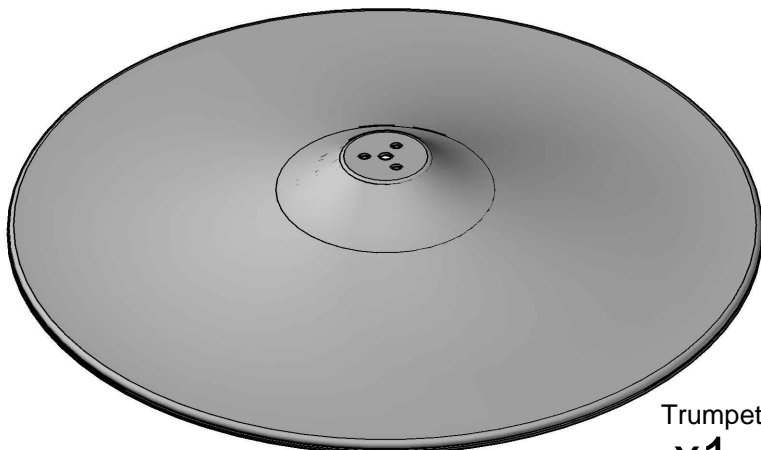

Trumpet Base
x1

1

Step 1

Screw the nut until it sits flush with the end of the threaded bar.

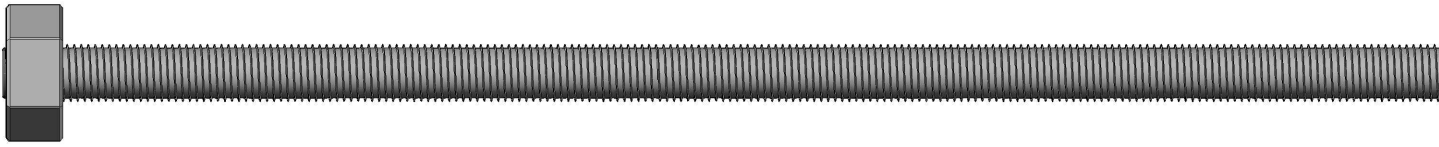
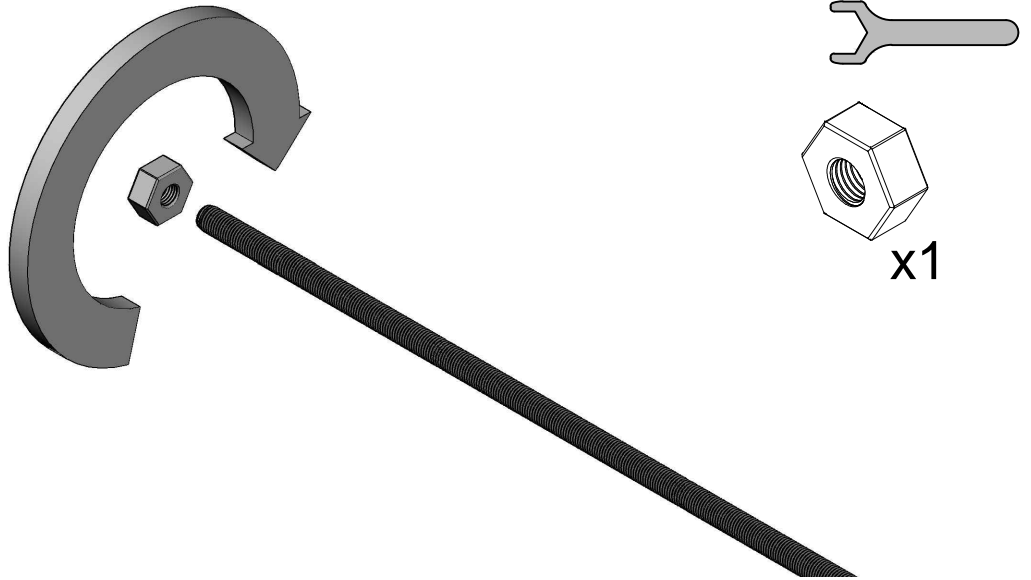

2

Step 2

Push on the top fixing bracket all the way until it meets the nut. The nut should sit inside the pre moulded recess inside the top fixing bracket.

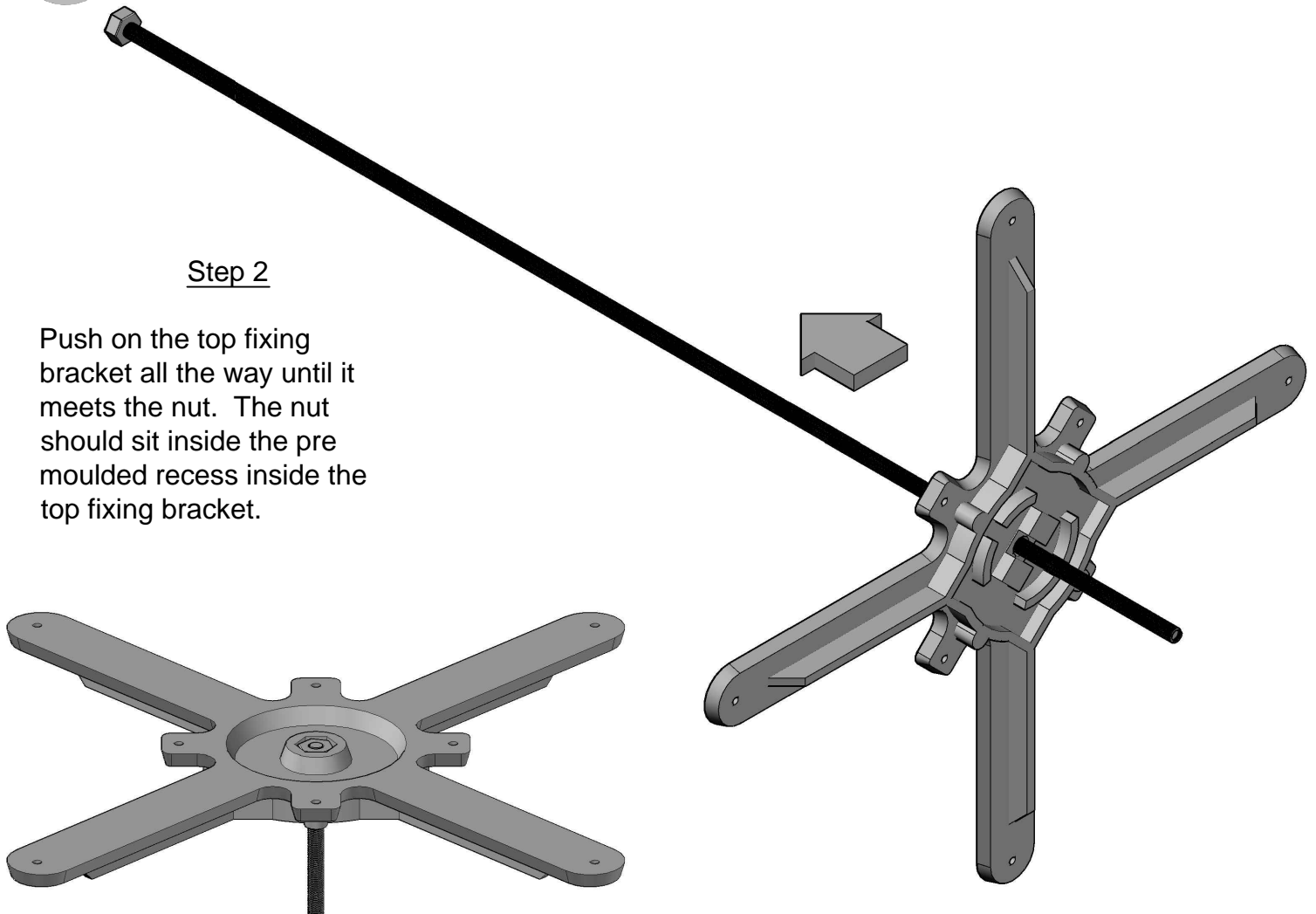

3

Step 3

Place on the floor with the threaded bar facing upwards as shown.

Slide the column onto the bar ensuring that the bar comes through the central hole in the column. See Diagram A.

The assembled base should now look like diagram B

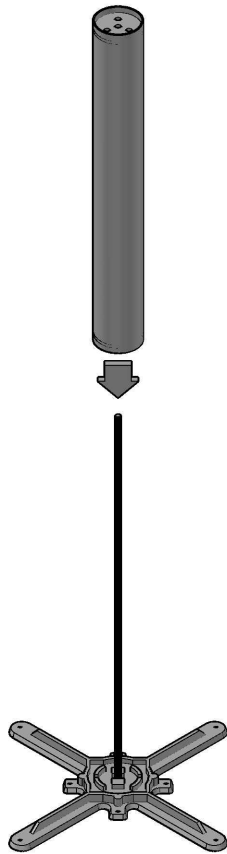

Diagram A

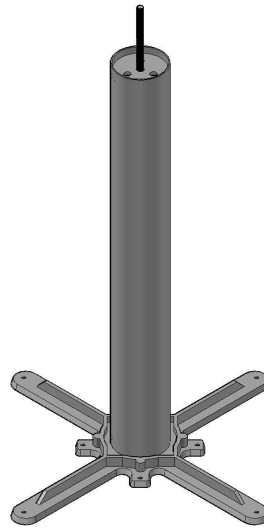
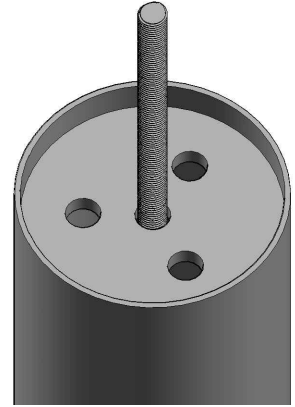
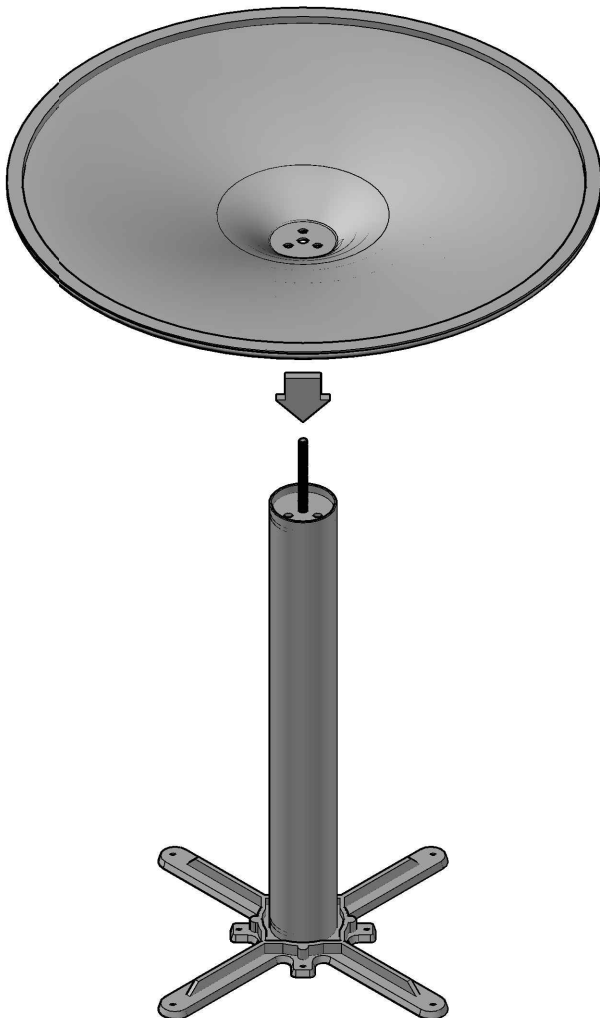

Diagram B

4



Step 4

Place the trumpet base onto the threaded bar. Once again ensure that the bar comes through the central hole in the base.

Step 6

Place the 4kg counter weight onto the threaded bar.

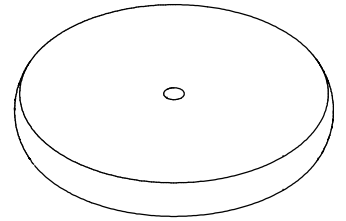

4kg Counter Weight
x1

Step 7

Place the 8kg counter weight onto the threaded bar.

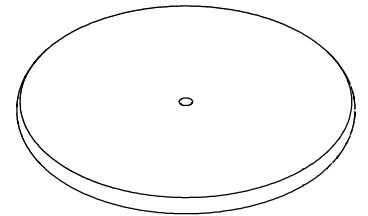
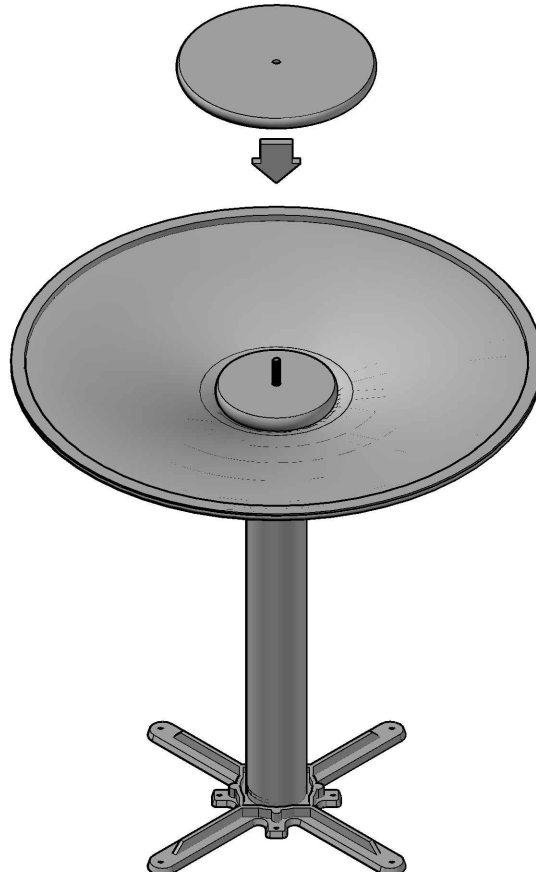

8kg Counter Weight
x1

Step 8

Screw on the remaining nut to the threaded bar.

Tighten up as much as possible to remove any wobble or movement in the table column.

Step 9

Turn the table base upright.

Refer to the table top instructions for details on how to attach your table top to the base.

