

# ASSEMBLY INSTRUCTIONS 6963BLK

1.

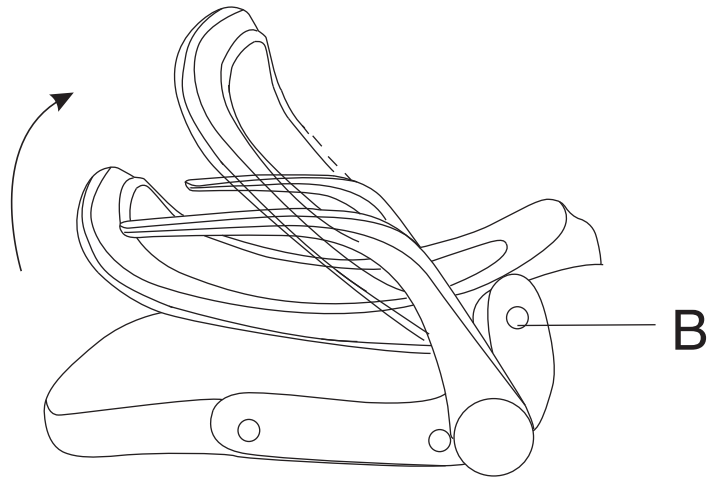

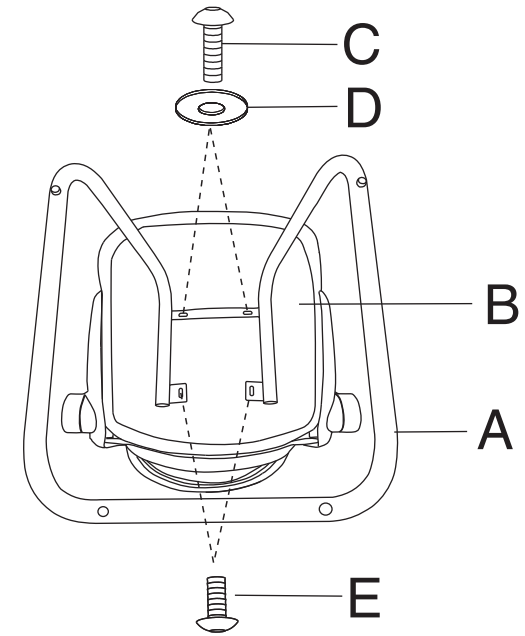



2.

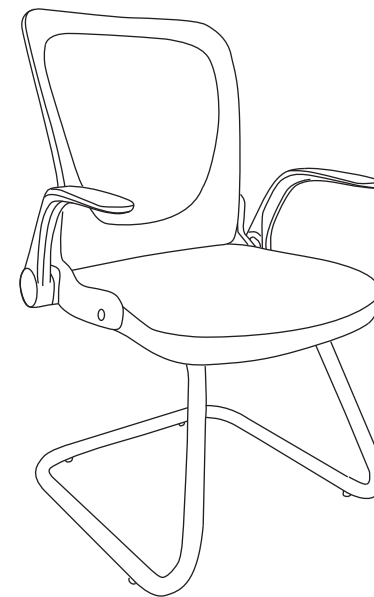
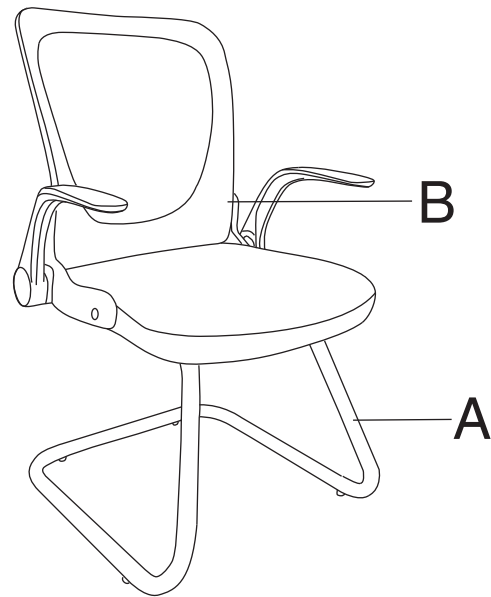

3.



- C**  M6\*25MM /2PCS
- D**  M8\*22 \*1.5MM /2PCS
- E**  M6\*20MM /2PCS
- F**  M5/1PC