

## 5 Litre Air Cooler



**IG9706**

Batch code:

**Please read these instructions carefully before use and retain for future reference**

**Before switching on your appliance,  
always check for any damage which may have been caused in transit**

# CONTENTS

Important Safety Instructions.....	3-5
Appliance Overview.....	6
Operating Instructions.....	6-10
Cleaning and Maintenance .....	10-11
Trouble Shooting Guide.....	12
Disposal Information.....	13
Fuse Replacement.....	13
Terms and Conditions and Warranty Information.....	14-15

## SAFETY INSTRUCTIONS

Carefully read the instructions before operating the unit.  
Please retain this manual for future reference.

1. If the supply cord is damaged, it must be replaced by the manufacturer, a service agent or a similarly qualified person to avoid a hazard.
2. Household and indoor use only.
3. This appliance can be used by children aged from 8 years and above and persons with reduced physical, sensory or mental capabilities or lack of experience and knowledge if they have been given supervision or instruction concerning use of the appliance in a safe way and understand the hazards involved. Children shall not play with the appliance. Cleaning and user maintenance shall not be made by children without supervision.
4. Unplug the appliance during filling and cleaning.
5. Prior to cleaning or other maintenance, the appliance must be disconnected from the supply mains.
6. Correct Disposal of this product



- This marking indicates that this product should not be disposed with other household wastes throughout the UK/EU. To prevent possible harm to the environment or human health from uncontrolled waste disposal, recycle it responsibly to promote the sustainable reuse of material resources. To return your used device, please use the return and collection systems or contact the retailer where the product was purchased. They can take this product for environmental safe recycling. The packaging material is recyclable. Dispose of the packaging in an environmentally friendly manner and make it available for the recyclable material collection-service.
7. Non-specialized personnel or unauthorized repair personnel shall not repair or modify the machine.
  8. Under no circumstances can the appliance be used with wet

- hands. This is to avoid electric shock.
9. If the unit is not in use for a long time, unplug the power cord.
  10. To prevent accidental injury or damage to the unit, please do not insert any foreign matter into the air inlet and outlet, because the unit incorporates a high-speed wind rotor.
  11. It is prohibited to use this unit in environments with flammable and explosive gases and direct sunlight for a long period shall be avoided.
  12. Do not place this unit on an incline or uneven flooring. It must be on level flooring to work properly.
  13. This machine has a safety switch. If the honeycomb filter support has not been installed well, the unit will not work as usual; when the machine is working, do not remove the honeycomb filter frame.
  14. At any time the water level in the tank shall not exceed “MAX” (maximum) scale, and during humidification, the total water level in the tank shall be controlled, and shall not be below “MIN” (minimum) scale.
  15. After the water tank is filled with water, do not tilt or collide with the unit when placing or moving it. To move the unit body, please move it slowly from the side to prevent water overflow.
  16. When in use make sure the unit is stable to prevent it from falling over. If the unit topples over accidentally, and it contains water, unplug the power cord immediately and take it to a qualified service engineer.
  17. Do not place items on the unit or cover the unit in any way with cloth or similar materials.
  18. When washing the outer panels of the unit, only use a damp cloth. Do not use solvents or corrosive cleaning agents.
  19. Do not have the air inlet and outlet of the unit close to walls, curtains and other objects, as they may block the airflow and affect air supply.
  20. When in use make sure not to knock or hit the unit as this could lead to the appliance automatically shutting down. If this happens

the unit will need to be manually restarted.

21. Ensure the water is changed regularly, particularly in warmer temperatures to prevent the water stagnating and creating odours. If the indoor temperature is below zero, it is best to use warm water for humidification.
22. Do not place the unit directly below the power outlet.
23. Do not use the unit around the tub, sprinkler or swimming pool.
24. Product repair must be carried out by a qualified service engineer.
25. To protect against the risk of electrical shock, do not immerse the unit, cord or plug in water or other liquid.
26. If a damp cloth has been used to wipe the unit, ensure it is dried again with a dry cloth.
27. Please note that high levels of humidity in a room can lead to build up of mould. Humidity levels should always be controlled inside the home wherever possible to prevent this from happening.
28. Do not permit the area around the humidifier to become damp or wet. If dampness occurs, turn the output of the humidifier down. If the humidifier output volume cannot be turned down, use the humidifier intermittently. Do not allow absorbent materials, such as carpeting, curtains, drapes, or tablecloths, to become damp.

## **RULES FOR SAFE OPERATION**

1. Never insert fingers, pencils, or any other object through the grille when air cooler is running.
2. Disconnect air cooler when moving from one location to another.
3. Be sure air cooler is on a stable surface when operating to avoid overturning.
4. DO NOT use air cooler by a window, as rain may create electrical hazard.
5. Household use only.

## APPLIANCE OVERVIEW

**NOTE:** Pictures in the manual are for reference only.

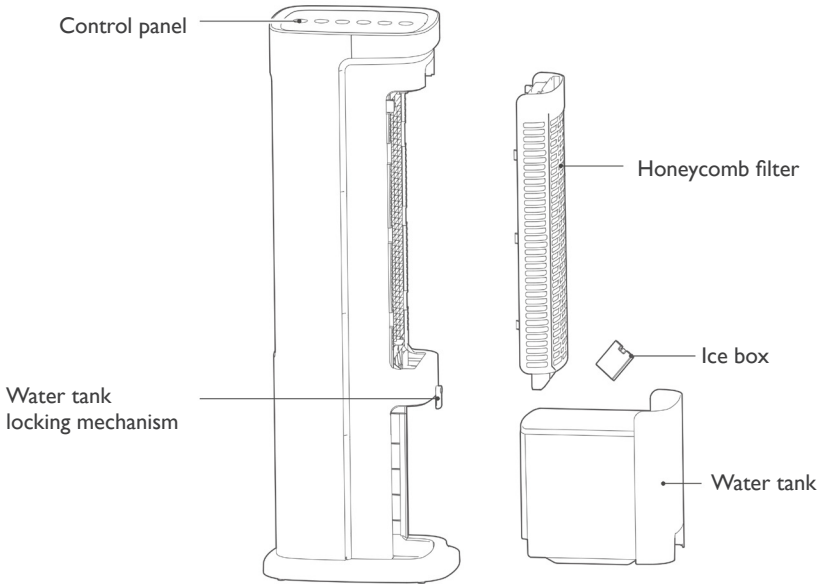

## OPERATING INSTRUCTIONS

### Guidance on filling with water, disassembling and washing of the water tank

**NOTE:**

- Ensure that the water tank is regularly emptied and cleaned when the air cooler is left unused for a prolonged period of time.
- Always remove the power plug when filling with water and cleaning.
- Always make sure that the water pump module is fixed securely in place before turning on the air cooler. If the water pump module is not securely fastened it can affect the performance of the unit when the CoolWind function is in use.
- To fill:  
Separate water pump module, and fully pull out the water tank, to feed water or clean the water tank.

## Filling the water tank

1. Unlock the water tank by rotating the locking mechanism 90 degrees.
2. Pull out the water tank and fill with water (making sure not to go over the maximum fill line), then once filled push the tank back into position and lock securely.

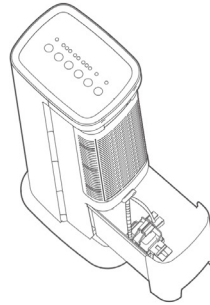
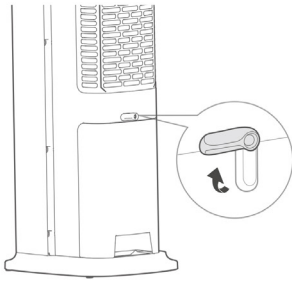

## Removing and cleaning the water tank

1. Rotate the locking mechanism 90 degrees anticlockwise to release the water pump module from the water tank (including the water pipe).
2. Once the water pump module has been detached, carefully remove the water tank from the unit so that it can be fully emptied of any stagnant water and cleaned thoroughly.

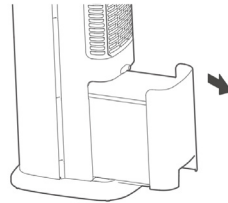
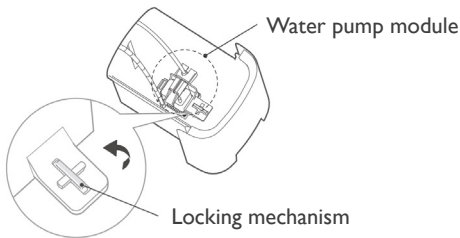

3. After cleaning the water tank, reinsert the water pump module back into the water tank. Insert front hook into the slot of the water tank, and then rotate locking mechanism clockwise 90°, and close it as shown below.
4. Push the water tank inside slowly, and rotate the locking mechanism to secure back in place

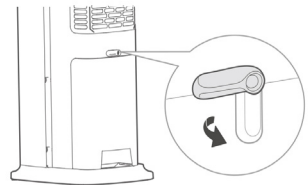
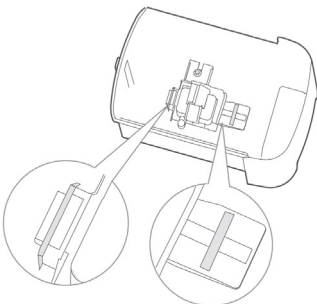

## Usage of the ice box

### NOTE:

1. The ice box can be frozen repeatedly and reused. You can also choose not to use it based on the temperature.
2. Please keep the ice box closed to prevent damage and liquid leakage.
3. The ice box is made of eco-friendly and toxic-free materials, and can be frozen safely.
4. When using the frozen ice box in the water tank, the temperature at the air outlet will drop after operating CoolWind function.
5. Ice blocks can be used to replace the frozen ice box, to create the same cooling effect.
6. Ensure that the water level in the water tank doesn't exceed the "MAX" (maximum) line on the front of the water tank, and if the water level is showing as lower than the "MIN" (minimum) please refill the tank before using the 'Cool Wind' function.

1. Pull the water tank out halfway from the air cooler unit.

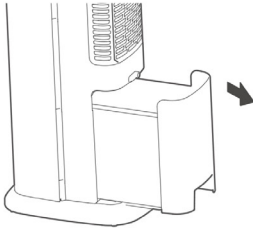



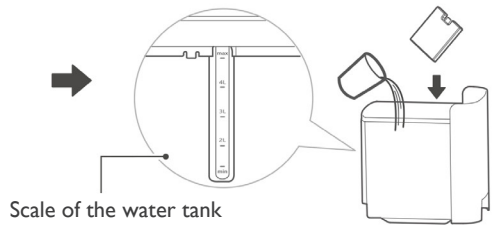





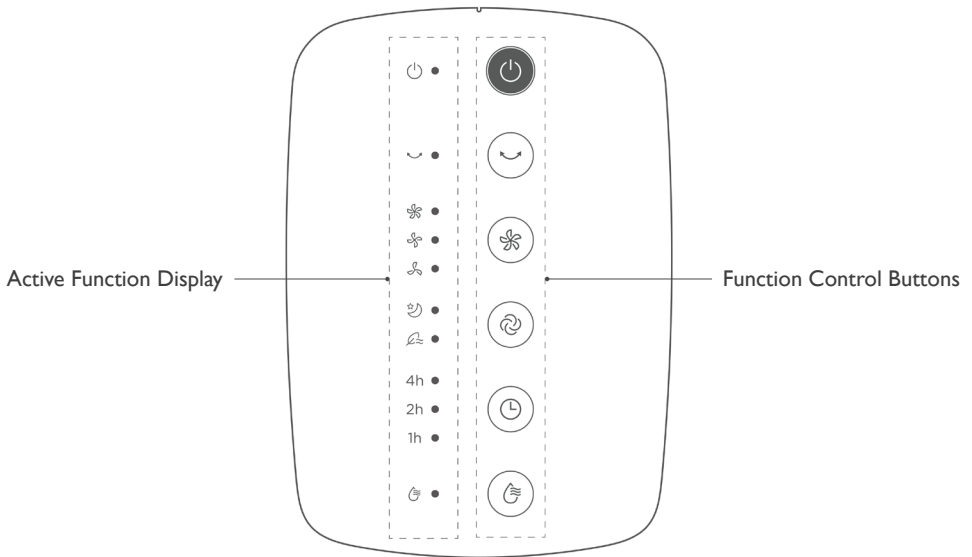



2. Take the ice box out of the package and place it inside a freezer to freeze for more than 3 hours. Put the frozen ice box in the water tank, and fill with water, ensuring it stays below the 'max' fill line.





## Control Panel



Buttons	Function description
 Startup/Standby	Press to turn the product on or off.
 Oscillation	Vertical louvres will oscillate if the unit is in operation.
 Wind Speed	Choose wind speed from LOW  , MEDIUM  , and HIGH  .
 Wind Type	Select from these three types of wind: Normal wind (the wind speed indicator light is on), sleep wind (sleep wind  the indicator light is on), natural wind (natural wind  the indicator light is on).
 Delay Timer	Set a delay timer for the air cooler to automatically shut down after a selected period of time. Press the button repeatedly to cycle through delay shutdown time options ranging from 1 - 7 hours (the time chosen will be shown by the sum of the lights that are illuminated on the Active Function Display next to the Delay Timer button)
 Cool Wind	Activating the Cool Wind function will mean the air cooler is adding moisture to the air from the water drawn out of the tank to help increase the cooling effect of the unit. If  indicator light flashes, refill the water tank before starting this function.

## Remote control button description

### NOTE:

- The remote control should be normally used within 5 metres of the front of the product and 30 degrees of the deviation angle.
- Battery acid can be harmful, so please always recycle waste batteries safely and separately.

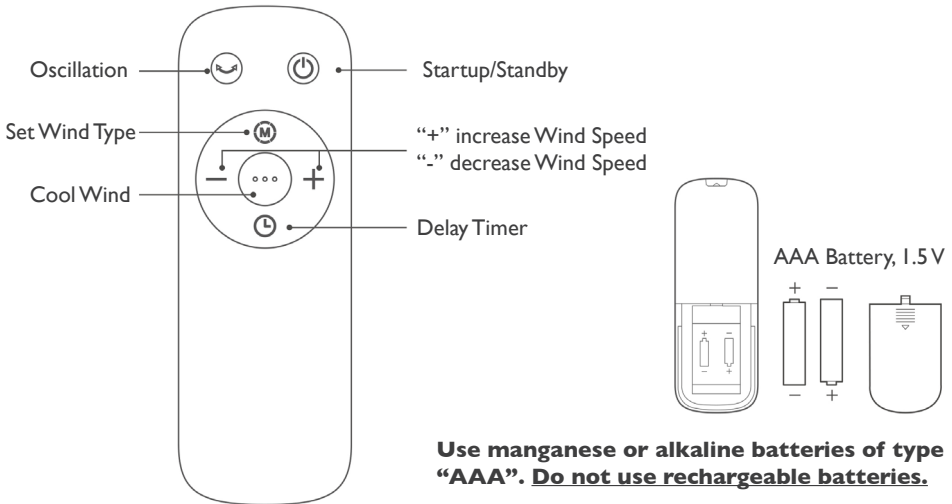

**NOTE:** On the unit control panel,  shows Wind Type selection. On the remote it is shown by .

**NOTE:** On the unit control panel,  selects Cool Wind. On the remote, this same function is shown by ... .

## CLEANING & MAINTENANCE

### NOTE:

- Disconnect the power before cleaning the product. Clean after the product is shut down for two minutes.
- Prevent from using any abrasive tools and solvents that may damage the surface to clean up the product. Detergent can be used for cleaning, and then wiped clean with a dry cloth afterwards. Prevent from washing the machine body with water directly, and wash disassemble parts (honeycomb filter parts) with a soft brush.
- **Only replace internal parts once they are fully dry.**
- Do not take apart or modify any of the internal pieces. It is recommended that this product should be checked and cleaned regularly in order to extend its service life.

## Guidance on the disassembly and installation of honeycomb filter parts

1. Remove the honeycomb filter support.

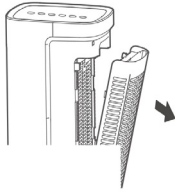

2. Rotate the bottom locking mechanism 90 degrees anticlockwise, and then remove the honeycomb filter.

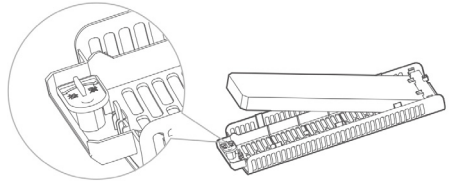

3. Take out the honeycomb filter for cleaning. With a mild detergent and a soft brush, scrub the honeycomb filter with clean water and then leave to dry fully before placing back into the filter support.

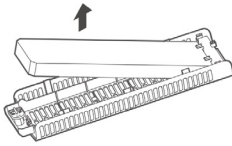

4. Re-install the honeycomb filter support once all pieces are clean and dry.

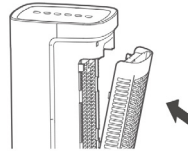

## Replace water

After the Cool Wind function has stopped for 2 minutes, you can then remove the water tank to refill it, as the water will have returned to the water tank after being circulated through the unit.

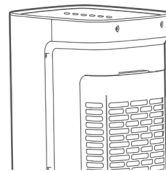

Stop the Cool Wind function for 2 minutes.

# TROUBLE SHOOTING GUIDE

If you are having problems with your appliance, please use our troubleshooting guide below. If you are unable to resolve the issue using this guide please ring our Customer Service Department on 0844 848 5861. Please have the model code and purchase information available.

Faults	Fault description
The unit will not switch on	Check Trip Switch / Fuse
	Check if the plug is connected to mains socket correctly
	Check batteries in the remote control
Runs for a short while and then switches off	Check if air outlet is blocked, if so remove obstacle
	Check if Delay Timer function has been activated
The unit has been running for a long period and then switches off	The overheat protection has been activated to protect the motor – turn unit off for a least 10 minutes and then switch back on
Runs without cooling in Cool Wind mode and Empty Tank Indicator blinking	The water tank is empty and needs to be re-filled
	Check if the air filter is dirty – if so, clean
	Check if air outlets or inlets are blocked
Water is leaking from unit when moving	Check that the tank has not been filled above the MAX line. If it has been filled too high then carefully remove some of the water until it falls below the MAX line.
	Ensure unit is located on a flat and even surface
The honeycomb filter is blocked with dust.	Pull down the honeycomb filter and clean it.
The air inlet is blocked with dust	Remove the foreign matter

## Maintenance Instruction

The fan requires little maintenance. Do not try to fix it by yourself. Refer it to qualified service personnel if service is needed.

1. Before cleaning and assembling, appliance must be unplugged.
2. To ensure adequate air circulation to the motor, keep vents at the rear of the motor free of dust. Do not disassemble the appliance to remove dust.
3. Please wipe the exterior parts with a soft cloth soaking a mild detergent.
4. Do not use any abrasive detergent or solvents to avoid scratching the surface. Do not use any of the following as a cleaner: gasoline, thinner.
5. Do not allow water or any other liquid into the motor housing or interior parts.

## Cleaning

1. Be sure to unplug from the electrical supply source before cleaning.
2. Plastic parts should be cleaned with a soft cloth moisten with mild soap. Thoroughly remove soap film with dry cloth.

## DISPOSAL INFORMATION

The European Directive 2012/19/EU on Waste Electrical and Electronic Equipment (WEEE), requires that old household electrical appliances must not be disposed of in normal unsorted municipal waste.



Old appliances must be collected separately in order to optimise the recovery and recycling of the materials they contain and reduce the impact on human health and the environment.

The crossed out “wheeled bin” symbol on the product reminds you of your obligation, that when you dispose of the appliance it must be separately collected. Consumers should contact their local authority or retailer for information concerning the correct disposal of their old appliance.

## MAINS PLUG FUSE REPLACEMENT

### Fuse Replacement (Class II)

Remove the fuse cover with a small flat head screw driver. Take out the fuse and replace with a new fuse of the same Amp. Replace the fuse cover and push back into place.

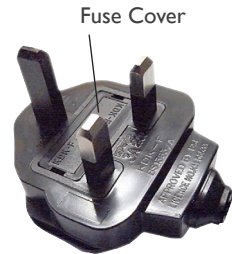



## Igenix Warranty Terms & Conditions

This product is guaranteed for a period of 12 months as standard from the date of purchase against mechanical and electrical defects. You can extend your warranty for a further 12 months by registering your product.

Upon registration we will cover your product for a period of 24 months from the original purchase date against any mechanical or electrical defects.

To qualify for the warranty, the product must be used for domestic household use only and in accordance with the instructions in the user manual. Any misuse of the product will result in the warranty being void.

The warranty does not cover accidental damage, misuse, neglect, tampering or incorrect adjustment or installation.

The warranty will be rendered invalid if the product is resold, has had its serial number removed (or has an invalid serial number), or if an unauthorised person has carried out any repairs or alterations.

The warranty does not cover accessories or consumable parts that require replacement under normal use. This includes shelving, dials, filters, belts and trays etc.

In the unlikely event of a breakdown please refer to the Troubleshooting guide in your user manual and check all plugs, fuses and the electricity supply.

If you still require assistance please contact our Customer Service department on **01473 271 272** or write to us at the following address:

**Customer Service Department  
38 Bluestem Road, Ransomes Europark  
Ipswich, IP3 9RR**

Please quote the Product Code which begins 'IG' or 'DF' and the PO Number on the front of the manual, and give details of the exact fault. We will then decide whether to repair or replace the item.

Before we arrange the repair or replacement you will be required to return a copy of your proof of purchase. Please retain your original.

If an item is replaced within the agreed warranty period, the warranty for the replacement item will be calculated from the purchase date of the original.

In the event that the product is inspected and no fault is found or the product is not within the warranty period you will be charged for the repair and any carriage costs.



## **Thank you for choosing Igenix**

As a valued customer we would like to offer you a FREE 2 year warranty to cover your product against any electrical or mechanical defects.

This means that in the unlikely event you develop a fault or problem with your product we will happily repair or replace the item free of charge.

To qualify for the 2 year warranty you must register your product within 30 days of purchase. The full Terms & Conditions of our warranty policy are shown on the opposite page. They are also available on our website. **[www.igenix.co.uk](http://www.igenix.co.uk)**

# **igenix**

**38 Bluestem Road, Ransomes Europark, Ipswich, IP3 9RR**

**Tel. 01473 271 272**

Disclaimer: Igenix operate a policy of continual improvement and development.  
We therefore reserve the right to change/alter the specification and appearance of our appliances without prior notice.  
All diagrams and images shown in this manual are for illustration purposes only.