



About Us



SPACERIGHT
europe ltd

Spaceright Europe Ltd is the UK's leading manufacturer of display and presentation products, dining solutions and early years furniture.

As a UK manufacturer, we are proud that our trusted brands and products can be found in schools, nurseries and offices across the UK and beyond. Innovation, quality, service and design are at the forefront of everything we do and drive the continuing success of our business.

Design

With a history spanning 100 years, our product knowledge and market insight is unparalleled, so when it comes to designing products and spaces, we are experts in our field.

Innovation

We are dedicated to investing in new product development and technological efficiencies, to enable us to successfully deliver cutting edge solutions for our customers.

Service

Customer service is pivotal to our success and we strive to provide the very best expert advice, helpful product information and after-sales support, as well as, quick lead times and market-leading Gold Service Delivery.

Quality

We are committed to using the best quality materials and efficient production processes, to ensure we manufacture high-quality products that meet the needs of our customers and are durable, safe and reliable.



Dining Furniture 5

Writing Boards 29

Flip Chart Easels 51

WeatherShield Showcases & Signage 57

Fire Retardant Noticeboards 65

Noticeboards 75

Display & Exhibition 91

Classroom Furniture & Storage 113

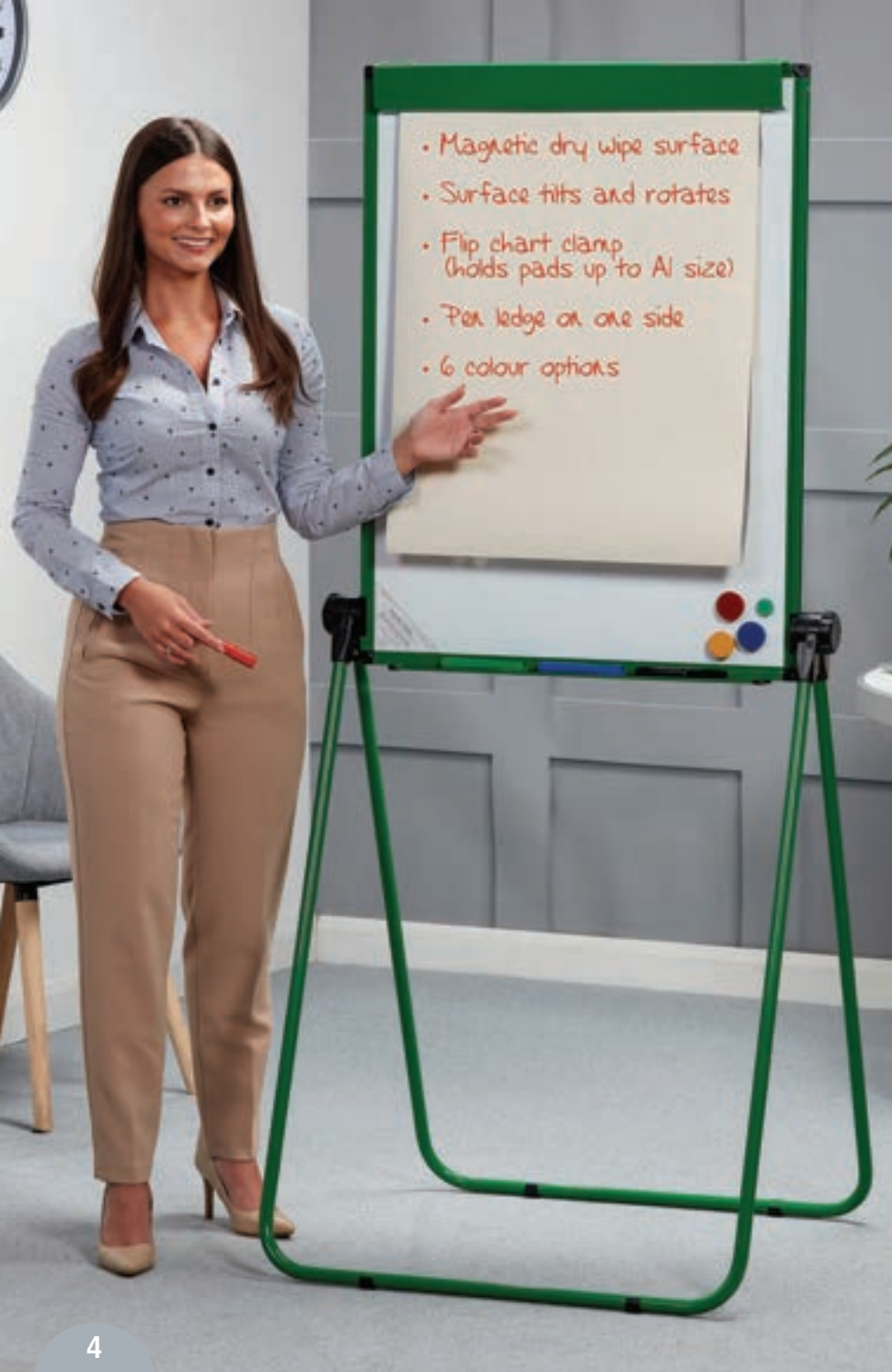

Icon Guide

These helpful product icons provide key information such as guarantees and lead time, throughout the catalogue:



Ordering

Orders can be placed online, by email or fax. All orders are subject to our standard terms and conditions, a copy of which is available online or upon request. Prices are shown exclusive of VAT, which will be applied at the current rate. Payment terms are 30 days net from invoice or proforma.

Delivery

Product lead times are indicated throughout the catalogue. Delivery is free on orders over £99.00 (exl. VAT). For orders under £99.00 (exl. VAT) a £10.00 (exl. VAT) delivery charge will apply upto 20kg (additional charge for more than 20kgs). All mobile dining furniture is delivered by our own transport (ground floor only). Additional charges apply outwith UK Mainland.

Guarantees

All of our products come with a guarantee, which represents our commitment to both quality and service. Our mobile dining tables have a 16 year warranty (on table mechanism and welds), whilst some of our writing boards benefit from a surface guarantee of up to 25 years.

Assembly

Our range includes fully assembled and self-assembly products that are identified throughout the catalogue. Where a product is self-assembly, all the instructions, screws and other fixings are in the box. In most cases we even supply the tools to do the job.

Accreditations

Spaceright Europe Ltd, a member of British Educational Supplies Association (BESA), has approved quality management and environmental management systems in place, giving us the following accreditations: ISO 9001:2015 and ISO 14001:2015.

Site Survey & Space Planning

We offer a completely free and comprehensive site survey and space planning service for our dining furniture range. Whether you have a detailed vision of what you want, or need inspiration, we can provide a solution which is right for you. Please see page 130 for further details.



All sizes stated are external board measurements unless otherwise noted e.g. poster cases. Colours as shown in the catalogue may vary from the actual colours due to photography and printing process. Full terms and conditions are available on request or via our web site. Spaceright Europe Ltd operate a policy of continuous improvement, therefore we reserve the right to alter the design or specification of a product without notice. Spaceright Europe Ltd claim their right as publishers of the copyright to this catalogue, therefore no content may be reproduced without written consent. E and O E.

Dining Furniture

Our flexible dining solutions enable schools to convert halls into multiuse areas effortlessly, without the need for heavy lifting.

In designing our dining furniture, we have used our expert knowledge of schools and similar environments, to deliver a comprehensive range of solutions that represent the very best in quality, versatility and value.

Our dining products benefit from:

- High-quality manufacturing
- Choice of heights and designs
- Free site survey (see pg. 130)
- Free space planning (see pg. 130)
- Free Gold Service Delivery (see pg. 130)

SPACERIGHT
europe ltd

spacerighteurope.com



Dining Furniture



Cube Table and Benches

- Stylish and modern in design
- Ideal solution for secondary, higher and further education establishments
- Benches store neatly underneath the table for space efficient storage
- Durable and sturdy construction with easy-clean surface
- 50mm thick laminated table top
- White steel frame
- 2 colours to choose from
- 5 year guarantee

Table Height	Seat Height	Age Range*
767mm	430mm	11+ Years

**Please note - age ranges are to be used as a guide only.*

Two modern colours to choose from



Benches store neatly underneath the table

Cube Table	Code	Price
767(h) x 1510(w) x 610mm (d)	9SCTWHITE	£386.00
767(h) x 1510(w) x 610mm (d)	9SCTOAK	£386.00

Cube Benches (Set of 2)	Code	Price
430(h) x 1390(w) x 305mm (d)	9SCBWHITE	£506.00
430(h) x 1390(w) x 305mm (d)	9SCBOAK	£506.00

Cube Set (Table & 2 x Bench)	Code	Price
Set (Table and 2 x bench)	9SCSWHITE	£788.00
Set (Table and 2 x bench)	9SCSOAK	£788.00

Colour Options



White Gloss
9001



Moderno Oak
9003

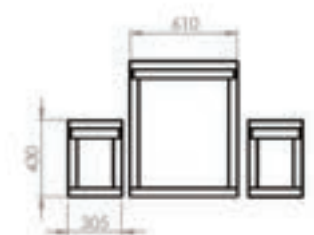
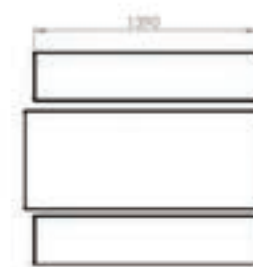



Modern

With a 50mm thick table top and square shaped frame, the Cube Table and Bench range will bring a modern feel and fresh look to your dining area.

Dining Furniture



Fast Fold Rectangular Table and Benches

- Slimline, space-saving tables and benches
- Unique folding mechanism allows legs to fold neatly into the frame
- Thinnest folding tables and benches on the market (Tables 40mm/Benches 46mm)
- 10 tables and 20 benches require only 0.8m² of space when stored on the trolley
- Lightweight aluminium frame design
- Steel legs for strength and stability
- 5 colours to choose from
- 5 year guarantee



Table and bench legs fold fully into the frame

Table Height Guide

Table Height	Seat Height	Age Range*
460mm	260mm	3-5 Years
530mm	330mm	4-7 Years
635mm	375mm	8-11 Years
710mm	450mm	12+ Years

*Please note - age ranges are to be used as a guide only.

Colour Options



Patent No. 2560852B

Fast Fold 1220mm Length

Fast Fold Table 1220mm(L) x 610mm(W)	Code	Price
460mm(h)	FFR4H0W1	£148.00
530mm(h)	FFR4H1W1	£148.00
635mm(h)	FFR4H2W1	£148.00
710mm(h)	FFR4H3W1	£148.00

Fast Fold Table 1220mm(L) x 685mm(W)	Code	Price
460mm(h)	FFR4H0W2	£148.00
530mm(h)	FFR4H1W2	£148.00
635mm(h)	FFR4H2W2	£148.00
710mm(h)	FFR4H3W2	£148.00

Fast Fold Bench 1220mm(L) x 305mm(W)	Code	Price
260mm(h)	FFB4H0	£126.00
330mm(h)	FFB4H1	£126.00
375mm(h)	FFB4H2	£126.00
450mm(h)	FFB4H3	£126.00

Fast Fold 1525mm Length

Fast Fold Table 1525mm(L) x 610mm(W)	Code	Price
460mm(h)	FFR5H0W1	£162.00
530mm(h)	FFR5H1W1	£162.00
635mm(h)	FFR5H2W1	£162.00
710mm(h)	FFR5H3W1	£162.00

Fast Fold Table 1525mm(L) x 685mm(W)	Code	Price
460mm(h)	FFR5H0W2	£162.00
530mm(h)	FFR5H1W2	£162.00
635mm(h)	FFR5H2W2	£162.00
710mm(h)	FFR5H3W2	£162.00

Fast Fold Bench 1525mm(L) x 305mm(W)	Code	Price
260mm(h)	FFB5H0	£132.00
330mm(h)	FFB5H1	£132.00
375mm(h)	FFB5H2	£132.00
450mm(h)	FFB5H3	£132.00

Fast Fold 1830mm Length

Fast Fold Table 1830mm(L) x 610mm(W)	Code	Price
460mm(h)	FFR6H0W1	£174.00
530mm(h)	FFR6H1W1	£174.00
635mm(h)	FFR6H2W1	£174.00
710mm(h)	FFR6H3W1	£174.00

Fast Fold Table 1830mm(L) x 685mm(W)	Code	Price
460mm(h)	FFR6H0W2	£174.00
530mm(h)	FFR6H1W2	£174.00
635mm(h)	FFR6H2W2	£174.00
710mm(h)	FFR6H3W2	£174.00

Fast Fold Bench 1830mm(L) x 305mm(W)	Code	Price
260mm(h)	FFB6H0	£139.00
330mm(h)	FFB6H1	£139.00
375mm(h)	FFB6H2	£139.00
450mm(h)	FFB6H3	£139.00



Lightweight

Designed for simplicity of use, the Fast Fold Tables and Benches are lightweight but sturdy, with an aluminium frame and steel legs for strength and stability. The thinnest folding tables and benches on the market.

Dining Furniture

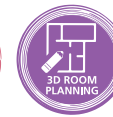

Fast Fold Trolley sets

- Slimline, space saving tables and benches
- Unique folding mechanism allows legs to fold neatly into the thinnest frame on the market (Tables 40mm/Benches 46mm)
- 10 tables and 20 benches require only 0.8m² of space when stored on the trolley
- Steel legs for strength and stability
- Designed to easily fit through doors
- 5 colours to choose from
- 5 year guarantee

Colour Options

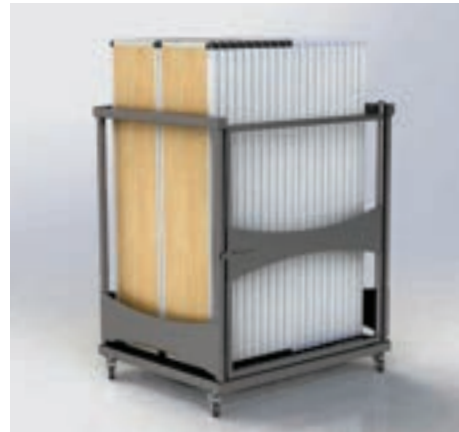

Patent No. 2560852B

Trolley with 10 tables and 20 benches	Code	Price
Table and bench length: 1220mm x Table width: 610mm / Bench width: 305mm		
Table Height: 530mm / Bench Height: 330mm	FFBUN2L4H1W1	£4235.00
Table Height: 635mm / Bench Height: 375mm	FFBUN2L4H2W1	£4235.00
Table Height: 710mm / Bench Height: 450mm	FFBUN2L4H3W1	£4235.00

Table and bench length: 1220mm x Table width: 685mm / Bench width: 305mm		
Table Height: 530mm / Bench Height: 330mm	FFBUN2L4H1W2	£4235.00
Table Height: 635mm / Bench Height: 375mm	FFBUN2L4H2W2	£4235.00
Table Height: 710mm / Bench Height: 450mm	FFBUN2L4H3W2	£4235.00

Table and bench length: 1830mm x Table width: 610mm / Bench width: 305mm		
Table Height: 530mm / Bench Height: 330mm	FFBUN2L6H1W1	£4710.00
Table Height: 635mm / Bench Height: 375mm	FFBUN2L6H2W1	£4710.00
Table Height: 710mm / Bench Height: 450mm	FFBUN2L6H3W1	£4710.00

Table and bench length: 1830mm x Table width: 685mm / Bench width: 305mm		
Table Height: 530mm / Bench Height: 330mm	FFBUN2L6H1W2	£4710.00
Table Height: 635mm / Bench Height: 375mm	FFBUN2L6H2W2	£4710.00
Table Height: 710mm / Bench Height: 450mm	FFBUN2L6H3W2	£4710.00

Trolley with 20 tables	Code	Price
Table length: 1220mm x Table width: 610mm		
Table Height: 530mm	FFBUN1L4H1W1	£3346.00
Table Height: 635mm	FFBUN1L4H2W1	£3346.00
Table Height: 710mm	FFBUN1L4H3W1	£3346.00

Table length: 1220mm x Table width: 685mm		
Table Height: 530mm	FFBUN1L4H1W2	£3346.00
Table Height: 635mm	FFBUN1L4H2W2	£3346.00
Table Height: 710mm	FFBUN1L4H3W2	£3346.00

Table length: 1830mm x Table width: 610mm		
Table Height: 530mm	FFBUN1L6H1W1	£3790.00
Table Height: 635mm	FFBUN1L6H2W1	£3790.00
Table Height: 710mm	FFBUN1L6H3W1	£3790.00

Table length: 1830mm x Table width: 685mm		
Table Height: 530mm	FFBUN1L6H1W2	£3790.00
Table Height: 635mm	FFBUN1L6H2W2	£3790.00
Table Height: 710mm	FFBUN1L6H3W2	£3790.00

Fast Fold Rectangular Table and Bench Trolley

- Designed to accommodate Fast Fold rectangular tables and benches for transportation and storage
- Unique design of tables and benches allows trolley to hold more tables and benches than any other on the market
- Holds up to 20 tables, 40 benches or 10 tables with 20 benches
- Heavy-duty steel construction
- Strong locking castors
- Designed to easily fit through doors



Designed to easily fit through doors

Rectangular Table and Bench Trolley

1040(w) x 1125(h) x 760mm(d)

Code

FFTROY

Price

£680.00



This holds all of this



Dining Furniture



8 Seat Round and Octagonal Mobile Folding Tables

- Mobile folding table with grey frame - easy to fold, store and clean
- Laminated table top with tough edging and MDF core (water resistant and easy-clean)
- Fits through standard height doorway (1980mm) for storage and transportation
- Open position safety lock to ensure table does not revert to folding position
- Folds into one position for both transport and storage
- Easy-clean intermediate lock for improved hygiene
- Choice of two heights (primary and secondary)
- Sturdy and wipe-clean plastic stools
- 11 stool colours to choose from
- Heavy-duty locking castors
- FIRA certified
- 16 year warranty on welds and mechanism

Folded to storage position



Table Height	Seat Height	Age Range*
685mm	375mm	5-11 Years
735mm	425mm	11+ Years

**Please note - age ranges are to be used as a guide only.*



Round Mobile Folding Table (8 Seat Unit)	Code	Price
685(h) x 2155mm (dia)	9SRL60827	£994.00
735(h) x 2155mm (dia)	9SRL60829	£994.00



Octagonal Mobile Folding Table (8 Seat Unit)	Code	Price
685(h) x 2155mm (dia)	9SRLOCT60827	£994.00
735(h) x 2155mm (dia)	9SRLOCT60829	£994.00

Round Table Top Colour Options

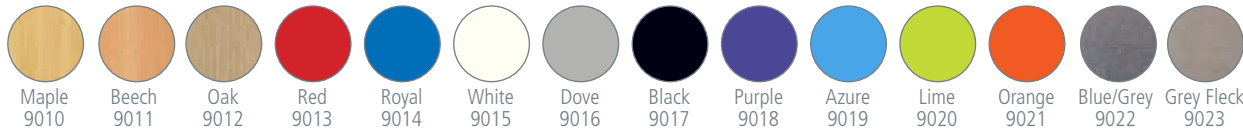

Octagonal Table Top Colour Options



Stool Colour Options (Round and Octagonal)

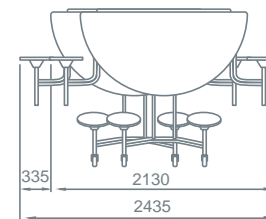
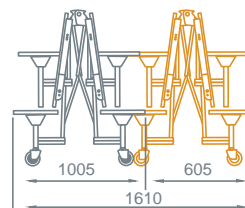
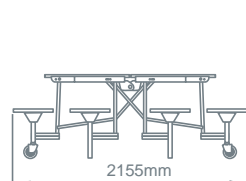
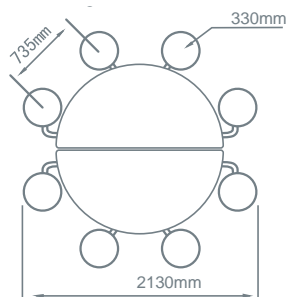

A	685mm	735mm
B	375mm	425mm
C	1330mm	1380mm
D	1005mm	1005mm

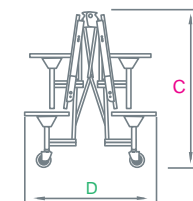
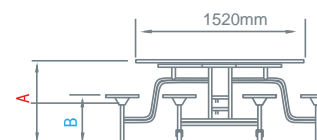



Effortless

Our Mobile Folding Tables make it quick and effortless to convert multiuse halls into dining areas, without the need for heavy lifting. A perfect solution for busy schools and canteens.

Dining Furniture



8 Seat Rectangular Mobile Folding Table

- Mobile folding table with grey frame - easy to fold, store and clean
- Laminated table top with tough edging and MDF core (water resistant and easy-clean)
- Fits through standard height doorway (1980mm) for storage and transportation
- Open position safety lock to ensure table does not revert to folding position
- Easy-clean intermediate lock for improved hygiene
- Transport and storage locking positions
- Choice of two heights (primary and secondary)
- Sturdy and wipe-clean plastic stools
- 14 table top colours to choose from
- 11 stool colours to choose from
- Heavy-duty locking castors
- FIRA certified
- 16 year warranty on welds and mechanism



Table Height	Seat Height	Age Range*
685mm	375mm	5-11 Years
735mm	425mm	11+ Years

**Please note - age ranges are to be used as a guide only.*

Rectangular Mobile Folding Table (8 Seat Unit)	Code	Price
685(h) x 2380(w) x 1500mm (d)	9SRL80827	£834.00
735(h) x 2380(w) x 1500mm (d)	9SRL80829	£834.00



Folded to transport position

Table Top Colour Options

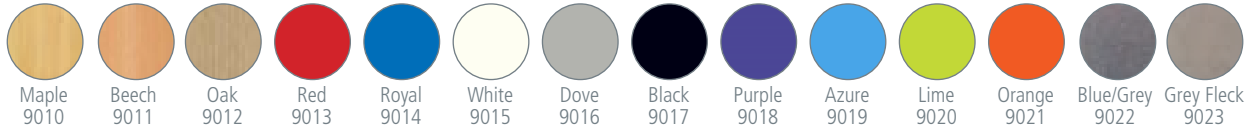

Stool Colour Options

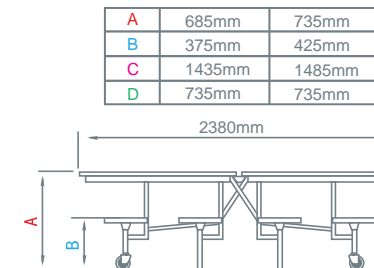
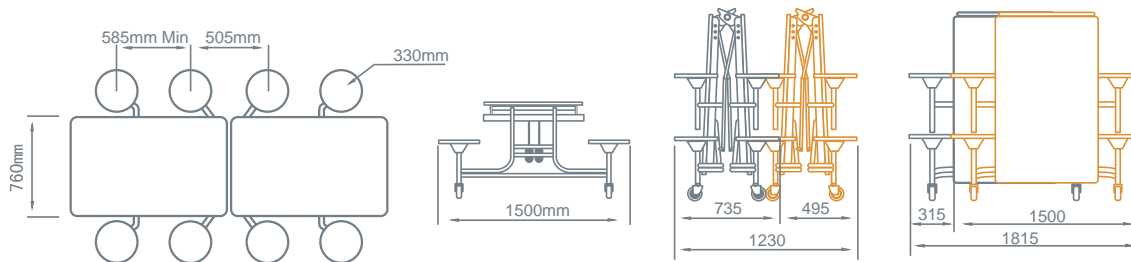



Hygienic

Safety and cleanliness are important factors in the design of our Mobile Folding Tables. Each one has an open position safety lock to ensure the table does not revert to the folding position, and an intermediate lock for improved hygiene.

Dining Furniture



12 Seat Rectangular Mobile Folding Table

- Mobile folding table with grey frame - easy to fold, store and clean
- Laminated table top with tough edging and MDF core (water resistant and easy-clean)
- Fits through standard height doorway (1980mm) for storage and transportation
- Open position safety lock to ensure table does not revert to folding position
- Easy-clean intermediate lock for improved hygiene
- Transport and storage locking positions
- Choice of two heights (primary and secondary)
- Sturdy and wipe-clean plastic stools
- 14 table top colours to choose from
- 11 stool colours to choose from
- Heavy-duty locking castors
- FIRA certified
- 16 year warranty on welds and mechanism

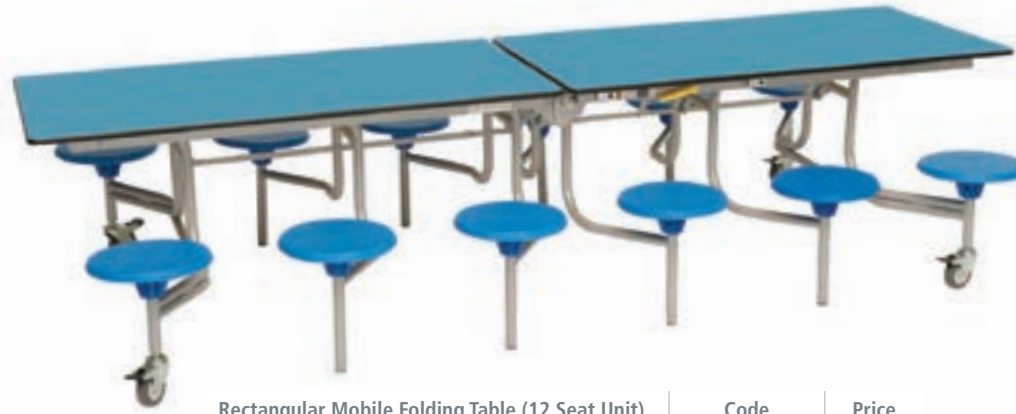

Rectangular Mobile Folding Table (12 Seat Unit)	Code	Price
685(h) x 3080(w) x 1500mm (d)	9SRL101227	£980.00
735(h) x 3080(w) x 1500mm (d)	9SRL101229	£980.00

Table Height	Seat Height	Age Range*
685mm	375mm	5-11 Years
735mm	425mm	11+ Years

**Please note - age ranges are to be used as a guide only.*

Folded to transport position



Table Top Colour Options

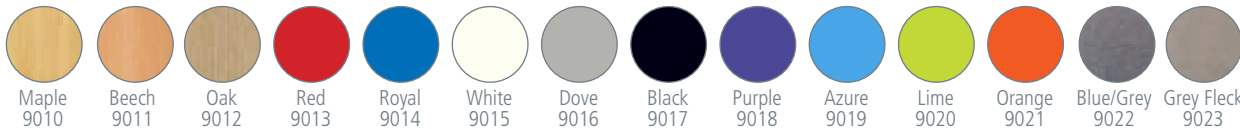

Stool Colour Options

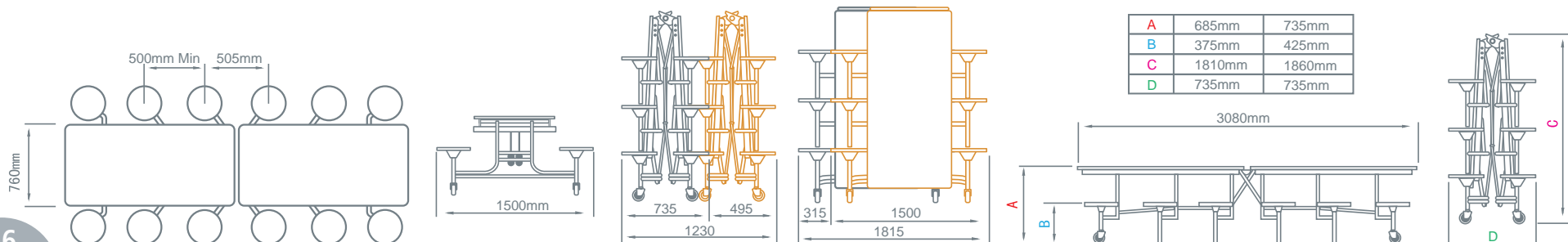

Popular

The twelve seat dining unit is the most popular configuration amongst schools. There are fourteen table top colours to choose from and two height options. The sturdy and flexible design is functional, practical and easy to use.



Dining Furniture



16 Seat Rectangular Mobile Folding Table

- Mobile folding table with grey frame - easy to fold, store and clean
- Laminated table top with tough edging and MDF core (water resistant and easy-clean)
- Fits through standard height doorway (1980mm) for storage and transportation
- Open position safety lock to ensure table does not revert to folding position
- Easy-clean intermediate lock for improved hygiene
- Transport and storage locking positions
- Sturdy and wipe-clean plastic stools
- Primary height 650mm
- 14 table top colours to choose from
- 11 stool colours to choose from
- Heavy-duty locking castors
- FIRA certified
- 16 year warranty on welds and mechanism



Table Height	Seat Height	Age Range*
650mm	340mm	4-11 Years

**Please note - age ranges are to be used as a guide only.*

Folded to storage position



Rectangular Mobile Folding Table (16 Seat Unit)	Code	Price
650(h) x 3280(w) x 1500mm (d)	9SRL101625	£1114.00

Table Top Colour Options

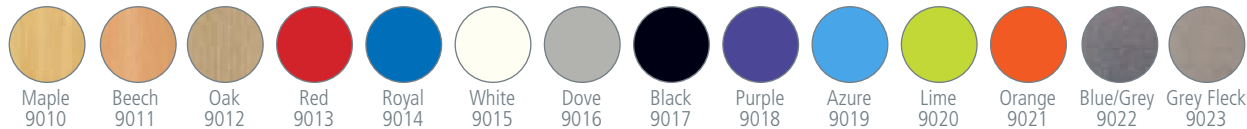

Stool Colour Options

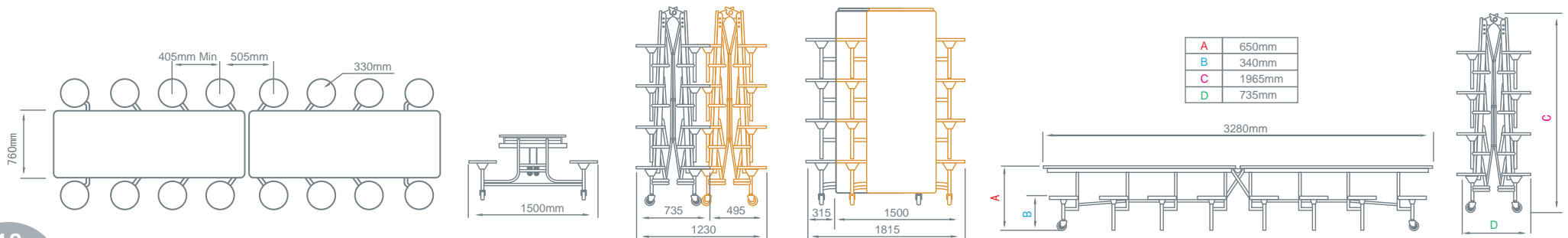



Functional

Designed specifically for primary school use, the sixteen seat unit is the ideal dining solution for younger children, not only is it easy to clean, but when not in use, is easy to store too.

Dining Furniture



Convertible Bench Unit - 3 benches in 1

- Versatile bench unit perfect for auditorium and classroom seating
- Join two units together to create a configuration ideal for cafeteria/dining use
- Laminated table top/bench with tough edging and MDF core (water resistant and easy-clean)
- Folding mechanism allows unit to be used as table with bench or bench with backrest
- Each bench seats between 4-6 children (depending on age)
- Choice of two heights (primary and secondary)
- 14 colours to choose from
- Heavy-duty locking castors
- FIRA certified
- 16 year warranty on welds and mechanism



Classroom Configuration
(Table with bench)



Auditorium Configuration
(Bench with backrest)

Table Height	Seat Height	Age Range*
685mm	375mm	5-11 Years
735mm	425mm	11+ Years

**Please note - age ranges are to be used as a guide only.*

Convertible Bench Unit	Code	Price
685(h) x 2435(w) x 730mm (d)	9SLCB827	£654.00
735(h) x 2435(w) x 730mm (d)	9SLCB829	£654.00

Colour Options

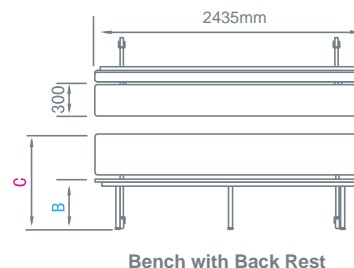
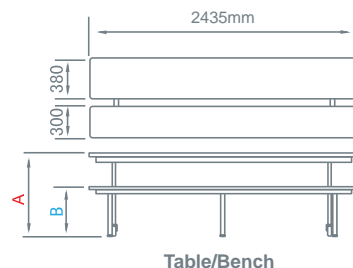
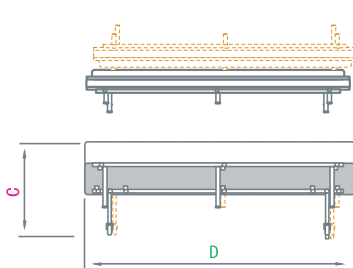
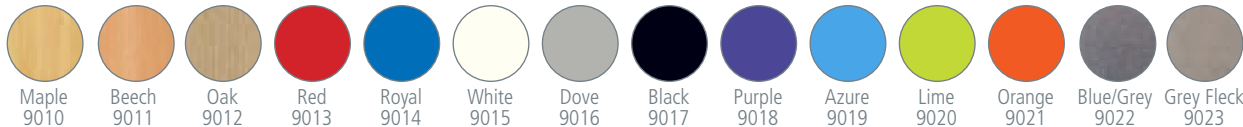

A	685mm	735mm
B	375mm	425mm
C	800mm	850mm
D	2485mm	2485mm

Convertible

Versatile in design, this bench unit is effectively three benches in one. Ideal for auditorium style seating, it can also be converted to a classroom table and then, by joining two units together, is perfect for dining use.



Cafeteria Configuration (two units joined)

Dining Furniture



Mobile Folding Bench Unit

- Mobile folding bench that seats between 12-16 children (depending on age)
- Easily accessible for children through six obstacle free entrances
- Laminated table top and bench with tough edging and MDF core (water resistant and easy-clean)
- Fits through standard height doorway (1980mm) for storage and transportation
- Open position safety lock to ensure table does not revert to folding position
- Easy-clean intermediate lock for improved hygiene
- Choice of two heights (primary and secondary)
- Folds into one position for both transport and storage
- 14 colours to choose from
- Heavy-duty locking castors
- FIRA certified
- 16 year warranty on welds and mechanism



Folded to transport and storage

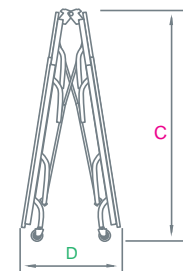
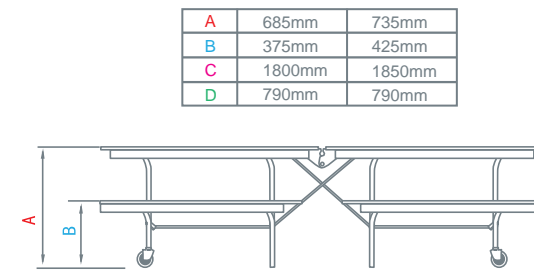
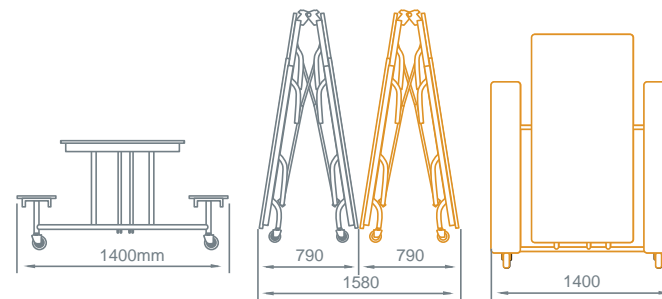
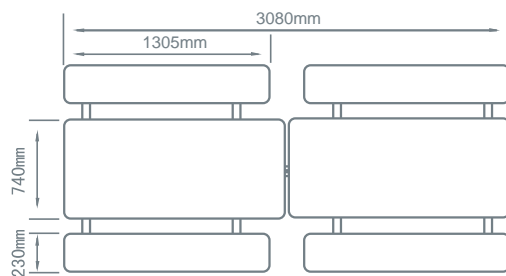
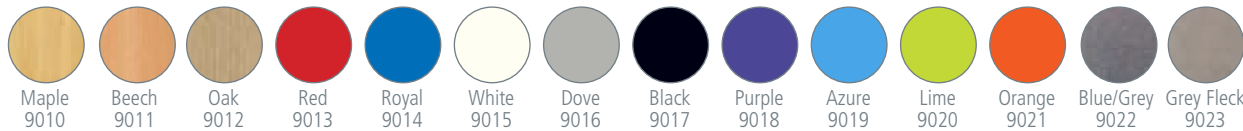

Table Height	Seat Height	Age Range*
685mm	375mm	5-11 Years
735mm	425mm	11+ Years

**Please note - age ranges are to be used as a guide only.*

Mobile Folding Bench	Code	Price
685(h) x 3080(w) x 1400mm (d)	9SLBU1027	£927.00
735(h) x 3080(w) x 1400mm (d)	9SLBU1029	£927.00

Colour Options



Accessible

The Mobile Folding Bench is ideal for busy lunch times and seats between twelve and sixteen children. This unit has the added benefit of being easily accessible through six obstacle free entrances.



Dining Furniture



8 Seat Primo Round Mobile Folding Table

- Contemporary dining table with gloss or oak effect table top
- Designed for use in secondary, higher and further education establishments
- 50mm thick laminated table top and grey frame
- Fits through standard height doorway (1980mm) for storage and transportation
- Open position safety lock to ensure table does not revert to folding position
- Easy-clean intermediate lock for improved hygiene
- Transport and storage locking positions
- Adult height 767mm
- 3 modern table top options to choose from
- 3 seat options to choose from
- Heavy-duty locking castors
- 16 year warranty on welds and mechanism

Table Height	Seat Height	Age Range*
767mm	435mm	11+ Years

**Please note - age ranges are to be used as a guide only.*

Colour Options



Watch the video

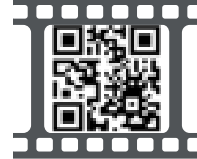

Scan the QR code



Full back option



Stool option



Seat option



Moderno Oak Primo Mobile Folding Table		Code	Price
767(h) x 2155mm (d)	Stool	9SRL60830PR03S	£1480.00
767(h) x 2155mm (d)	Seat	9SRL60830PR03	£1588.00
767(h) x 2340mm (d)	Full Back	9SRL60830PR03FB	£1860.00

White Gloss Primo Mobile Folding Table		Code	Price
767(h) x 2155mm (d)	Stool	9SRL60830PR02S	£1480.00
767(h) x 2155mm (d)	Seat	9SRL60830PR02	£1588.00
767(h) x 2340mm (d)	Full Back	9SRL60830PR02FB	£1860.00

Black Gloss Primo Mobile Folding Table		Code	Price
767(h) x 2155mm (d)	Stool	9SRL60830PR01S	£1480.00
767(h) x 2155mm (d)	Seat	9SRL60830PR01	£1588.00
767(h) x 2340mm (d)	Full Back	9SRL60830PR01FB	£1860.00

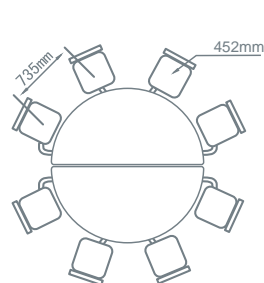

	Stool & Seat	Full Back
A	2155mm	2340mm
B	1066mm	1290mm
C	666mm	1040mm
D	1732mm	2330mm

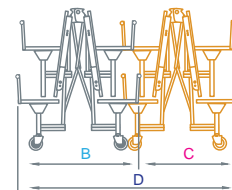
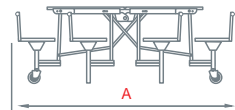

	Stool & Seat	Full Back
E	305mm	430mm
F	2155mm	2340mm
G	2460mm	2770mm

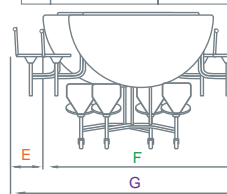

	Stool & Seat	Full Back
H	767mm	767mm
I	435mm	435mm
J	1066mm	1290mm
K	1860mm	1860mm

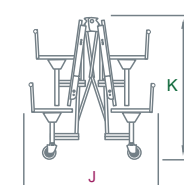
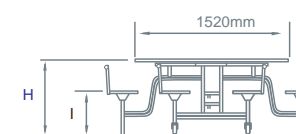

Contemporary

Primo tables combine all the key features of our standard Mobile Folding Tables with a contemporary style that is ideal for secondary, higher and further education establishments.



Dining Furniture



12 Seat Primo Rectangular Mobile Folding Table

- Contemporary dining table with gloss or oak effect table top
- Designed for use in secondary, higher and further education establishments
- 50mm thick laminated table top and grey frame
- Fits through standard height doorway (1980mm) for storage and transportation
- Open position safety lock to ensure table does not revert to folding position
- Easy-clean intermediate lock for improved hygiene
- Transport and storage locking positions
- 3 modern table top options to choose from
- 3 seat styles to choose from
- Adult height 767mm
- Heavy-duty locking castors
- 16 year warranty on welds and mechanism

Colour Options



White Gloss
9001



Black Gloss
9002



Moderno Oak
9003



Moderno Oak Primo Mobile Folding Table		Code	Price
767(h) x 3080(w) x 1500mm (d)	Stool	9SRL101230PR03S	£1374.00
767(h) x 3080(w) x 1500mm (d)	Seat	9SRL101230PR03	£1460.00
767(h) x 3080(w) x 1720mm (d)	Full Back	9SRL101230PR03FB	£1747.00



White Gloss Primo Mobile Folding Table		Code	Price
767(h) x 3080(w) x 1500mm (d)	Stool	9SRL101230PR02S	£1374.00
767(h) x 3080(w) x 1500mm (d)	Seat	9SRL101230PR02	£1460.00
767(h) x 3080(w) x 1720mm (d)	Full Back	9SRL101230PR02FB	£1747.00



Full back option



Stool option



Seat option



Black Gloss Primo Mobile Folding Table		Code	Price
767(h) x 3080(w) x 1500mm (d)	Stool	9SRL101230PR01S	£1374.00
767(h) x 3080(w) x 1500mm (d)	Seat	9SRL101230PR01	£1460.00
767(h) x 3080(w) x 1720mm (d)	Full Back	9SRL101230PR01FB	£1747.00

Watch the video

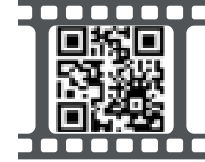

Scan the QR code

Table Height	Seat Height	Age Range*
767mm	435mm	11+ Years

*Please note - age ranges are to be used as a guide only.

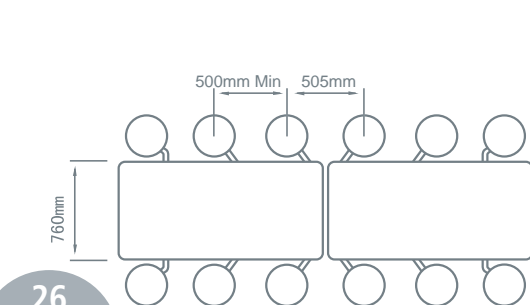

	Stool & Seat	Full Back
A	1500mm	1720mm
B	735mm	765mm
C	495mm	565mm
D	1230mm	1330mm

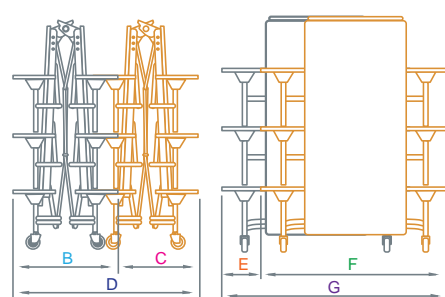
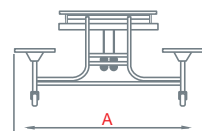

	Stool & Seat	Full Back
E	315mm	470mm
F	1500mm	1720mm
G	1815mm	2190mm

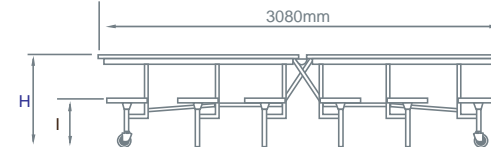

	Stool & Seat	Full Back
H	767mm	767mm
I	435mm	435mm
J	750mm	765mm
K	1860mm	1860mm

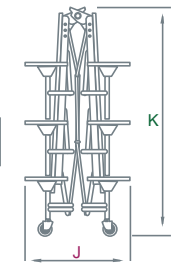

Comfort

With three seat styles to choose from, the Primo table combines stylish design with both flexibility and comfort. A fresh, modern solution for canteens and dining halls.



Dining Table Services

Spaceright Europe Ltd are experts in the manufacture and supply of innovative dining solutions, and we understand the importance of robust product design, quality and service. Buying dining furniture is an investment, so it's essential that you achieve a solution that meets your needs.



Site Survey (Free of charge service)

To help with the buying process, we would be delighted to arrange a free site survey. A member of our dedicated and experienced team will visit you to discuss your requirements and take the necessary measurements. For further details, please see pg. 130.

Space Planning (Free of charge service)

One of the most important services we provide to our customers is delivering detailed, aesthetic designs of cafeteria/dining room layouts. Our product design team are experts in creating bespoke dining solutions and space plans. For further details, please see pg. 130.



Free Gold Service Delivery

All orders for dining furniture (except Fast Fold) are delivered by our Free Gold Service Delivery. Our team will deliver your tables on a day that is convenient for you using sustainable packaging. We will unpack and commission the tables, then our expert team will provide training on using and caring for your tables. For further details, please see pg. 130.

Required Maintenance

- Regularly inspect table operation for smoothness and general stability
- Clean table tops according to current food service hygiene practices after each use
- Exterior components of tables should be inspected for food deposits and cleaned as required
- The underside of the tables should be inspected for chewing gum and other food deposits
- Every 6 months you should lubricate tables with a food grade silicon spray, which is required to pivot joints, or more often if indicated by stiff operation or noise
- Ensure tables are used in accordance with supplied operating instructions
- Caution:- Excessive use of water during cleaning may cause corrosion

Spaceright Europe Ltd offer an annual service and maintenance plan to help care for your tables. For further information and advice, please call 0845 6017619.



Writing Boards

Writing boards are an effective way to present information, whether it be for education, training or corporate use.

From traditional writing boards to efficient space saving solutions, we have a wide selection of boards to accommodate varying requirements.

With a selection of magnetic, non-magnetic and chalk surface options, all of our writing boards are durable and easy-clean.

- High-quality writing surfaces
- Designed to be practical and efficient
- Large selection of frames and sizes

SPACERIGHT
e u r o p e l t d

spacerighteurope.com



Writing Boards



Non-Magnetic Writing Board

- Non-magnetic, double-sided writing board
- Plain one side with grid on reverse
- Satin silver anodised aluminium frame
- Rounded safety corners and concealed corner fixings
- Pen ledge and wall fixings included
- Suitable for portrait or landscape use
- 5 year surface guarantee



5 Year Surface Guarantee	Code	Price
900(w) X 600mm(h)	0106	£38.00
1200(w) X 900mm(h)	0109	£57.00
1200(w) X 1200mm(h)	0112	£69.00
1500(w) X 1200mm(h)	0115	£79.00
1800(w) X 1200mm(h)	0118	£100.00
2400(w) X 1200mm(h)	0124	£129.00

Non-Magnetic Writing Board

- Non-magnetic, double-sided writing board
- Plain one side with grid on reverse
- Satin silver anodised aluminium frame
- Rounded safety corners and concealed corner fixings
- Pen ledge and wall fixings included
- Suitable for portrait or landscape use
- 10 year surface guarantee



10 Year Surface Guarantee	Code	Price
900(w) X 600mm(h)	0806	£42.00
1200(w) X 900mm(h)	0809	£67.00
1200(w) X 1200mm(h)	0812	£79.00
1500(w) X 1200mm(h)	0815	£107.00
1800(w) X 1200mm(h)	0818	£129.00
2400(w) X 1200mm(h)	0824	£162.00

Writing Board Accessories



Mini Dusters

Size	Code	Price
Pk 30	MINIDUSTER30	£23.00



Dry-wipe Pens Assorted

Size	Code	Price
Pk 4	DMPENSTASS4	£18.00



Dusters

Size	Code	Price
Single	WBERAS1	£18.00
Pk12	WBERAS12	£46.00



Dry-wipe Pens (Box of 10)

Size	Code	Price
Pk10 Black	DMPENSTBK10	£29.00
Pk10 Blue	DMPENSTBU10	£29.00
Pk10 Red	DMPENSTRD10	£29.00
Pk10 Green	DMPENSTGN10	£29.00



Board Conditioner

Size	Code	Price
250ml Spray	COND.25	£19.00
1.0lt Bottle	COND1	£21.00
2.5lt Bottle	COND2.5	£41.00

Practical

With a double-sided and easy-clean surface, our non-magnetic writing boards are the perfect practical display solution for education and office environments.

Sales Meeting

- * Sales Figures
- * Business Development
- * Actions Required
- * AOB





Magnetic Writing Board (Coated Steel)

- Magnetic writing board constructed from coated steel
- Satin silver anodised aluminium frame
- Rounded safety corners and concealed corner fixings
- Pen ledge and wall fixings included
- Suitable for portrait or landscape use
- 5 year surface guarantee



Magnetic Coated Steel Writing Board	Code	Price
900(w) X 600mm(h)	95151	£44.00
1200(w) X 900mm(h)	95152	£70.00
1200(w) X 1200mm(h)	95153	£93.00
1500(w) X 1200mm(h)	95157	£106.00
1800(w) X 1200mm(h)	95158	£119.00
2400(w) X 1200mm(h)	95159	£157.00

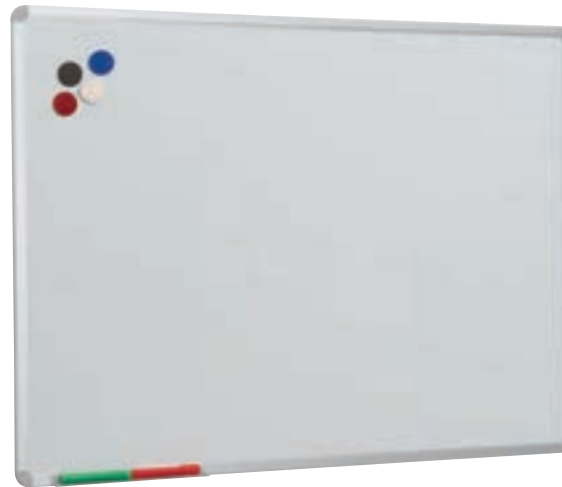

Magnetic Writing Board (Vitreous Enamel Steel)

- Superior magnetic vitreous enamel steel writing board
- Durable, anti-scratch surface for heavy use
- Satin silver anodised aluminium frame
- Rounded safety corners and concealed corner fixings
- Pen ledge and wall fixings included
- Suitable for portrait or landscape use
- 25 year surface guarantee

Magnetic VES Writing Board	Code	Price
900(w) X 600mm(h)	1306	£64.00
1200(w) X 900mm(h)	1309	£104.00
1200(w) X 1200mm(h)	1312	£132.00
1500(w) X 1200mm(h)	1315	£165.00
1800(w) X 1200mm(h)	1318	£180.00
2400(w) X 1200mm(h)	1324	£233.00

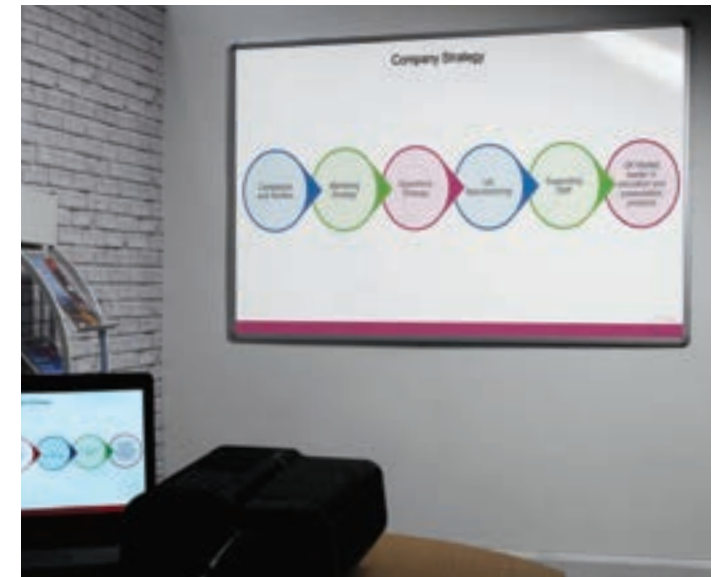

Magnetic Projection Board

- Dual use vitreous enamel steel projection board and magnetic writing surface
- Semi-matt surface finish to reduce projection glare
- Satin silver anodised aluminium frame
- Rounded safety corners and concealed corner fixings
- Pen ledge and wall fixings are included
- Suitable for portrait or landscape use
- 25 year surface guarantee



Magnetic VES Projection Board	Code	Price
1200(w) X 1200mm(h)	1112	£212.00
1500(w) X 1200mm(h)	1115	£268.00
1800(w) X 1200mm(h)	1118	£327.00
2400(w) X 1200mm(h)	1124	£382.00



Mag-notes

- Reusable magnetic dry-wipe notelets
- Suitable for use on magnetic/metal surfaces
- Ideal for office or education use
- Perfect for planning, presentations and more
- Pack of 40
- 10 of each colour: yellow, blue, pink, green
- 1 year guarantee

Mag-notes (Pack of 40)	Code	Price
75(w) X 75mm(h)	95200/40	£22.50





Non-Magnetic SmartShield Writing Board

- Non-magnetic writing board with stylish frame
- Premium finish and modern design
- Choice of 2 frame colours: aluminium or blue
- Rounded safety corners and concealed corner fixings
- Pen ledge and wall fixings included
- Suitable for portrait or landscape use
- 5 year surface guarantee

Magnetic SmartShield Writing Boards

- Magnetic writing board with stylish frame
- Premium finish and modern design
- Choice of 2 frame colours: aluminium or blue
- Rounded safety corners and concealed corner fixings
- Pen ledge and wall fixings included
- Suitable for portrait or landscape use
- 5 year surface guarantee



Non-Magnetic SmartShield Writing Board	Code	Price
900(w) X 600mm(h)	4731	£83.00
1200(w) X 900mm(h)	4732	£111.00
1200(w) X 1200mm(h)	4733	£129.00
1500(w) X 1200mm(h)	4734	£160.00
1800(w) X 1200mm(h)	4735	£174.00
2400(w) X 1200mm(h)	4736	£217.00

Magnetic SmartShield Writing Board	Code	Price
900(w) X 600mm(h)	4741	£89.00
1200(w) X 900mm(h)	4742	£119.00
1200(w) X 1200mm(h)	4743	£139.00
1500(w) X 1200mm(h)	4744	£170.00
1800(w) X 1200mm(h)	4745	£194.00
2400(w) X 1200mm(h)	4746	£221.00



Blue frame



Aluminium frame

Agenda

- Review of previous minutes
- Quality review

Stylish

With its stylish frame and sleek design, SmartShield noticeboards deliver a contemporary aesthetic. The perfect modern display solution.

Writing Boards



Non-Magnetic Mobile Writing Board

- Double-sided, non-magnetic writing board
- Plain one side with feint grid on reverse
- Mobile frame with locking castors and stability bar
- Portrait and landscape orientation available
- Height adjustable by 210mm
- 5 year surface guarantee

Non-Magnetic Writing Board Landscape	Code	Price
900(w) X 600mm(h)	1601L	£129.00
1200(w) X 900mm(h)	1603L	£144.00
1200(w) X 1200mm(h)	1605	£155.00
1500(w) X 1200mm(h)	1607L	£180.00
1800(w) X 1200mm(h)	1609L	£194.00

Non-Magnetic Writing Board Portrait	Code	Price
600(w) X 900mm(h)	1601P	£129.00
900(w) X 1200mm(h)	1603P	£144.00
1200(w) X 1500mm(h)	1607P	£180.00



Magnetic Mobile Writing Board

- Double-sided, magnetic writing board
- Plain both sides
- Mobile frame with locking castors and stability bar
- Portrait and landscape orientation available
- Height adjustable by 210mm
- 5 year surface guarantee



Magnetic Writing Board Landscape	Code	Price
900(w) X 600mm(h)	1611L	£139.00
1200(w) X 900mm(h)	1613L	£158.00
1200(w) X 1200mm(h)	1615	£179.00
1500(w) X 1200mm(h)	1617L	£219.00
1800(w) X 1200mm(h)	1619L	£239.00

Magnetic Writing Board Portrait	Code	Price
600(w) X 900mm(h)	1611P	£139.00
900(w) X 1200mm(h)	1613P	£158.00
1200(w) X 1500mm(h)	1617P	£219.00

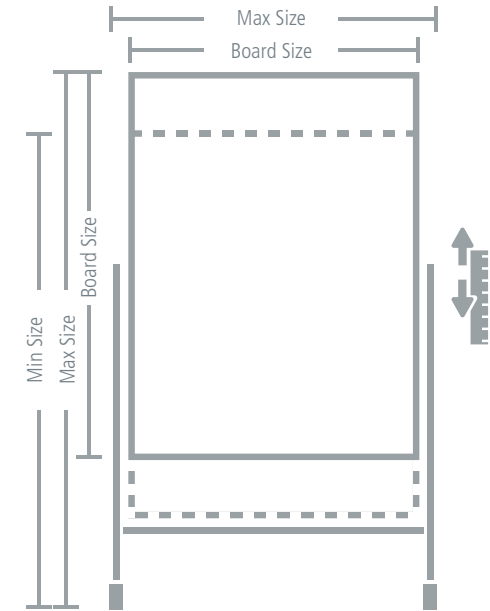

Board Size (w x h)	Max Overall Size (w x h)	Min Overall Size (w x h)
600 x 900 mm Portrait	640 x 1580 mm	640 x 1370 mm
900 x 600 mm Landscape	940 x 1420 mm	940 x 1210 mm
900 x 1200 mm Portrait	940 x 1730 mm	940 x 1520 mm
1200 x 900 mm Landscape	1240 x 1580 mm	1240 x 1370 mm
1200 x 1200 mm Square	1240 x 1730 mm	1240 x 1520 mm
1200 x 1500 mm Portrait	1240 x 1880 mm	1240 x 1670 mm
1500 x 1200 mm Landscape	1540 x 1730 mm	1540 x 1520 mm
1800 x 1200 mm Landscape	1840 x 1730 mm	1840 x 1520 mm

Adaptable

These mobile boards have two surfaces to maximise writing space. The sturdy frame and locking castors make it easy to transport between rooms or to position closer to the audience.

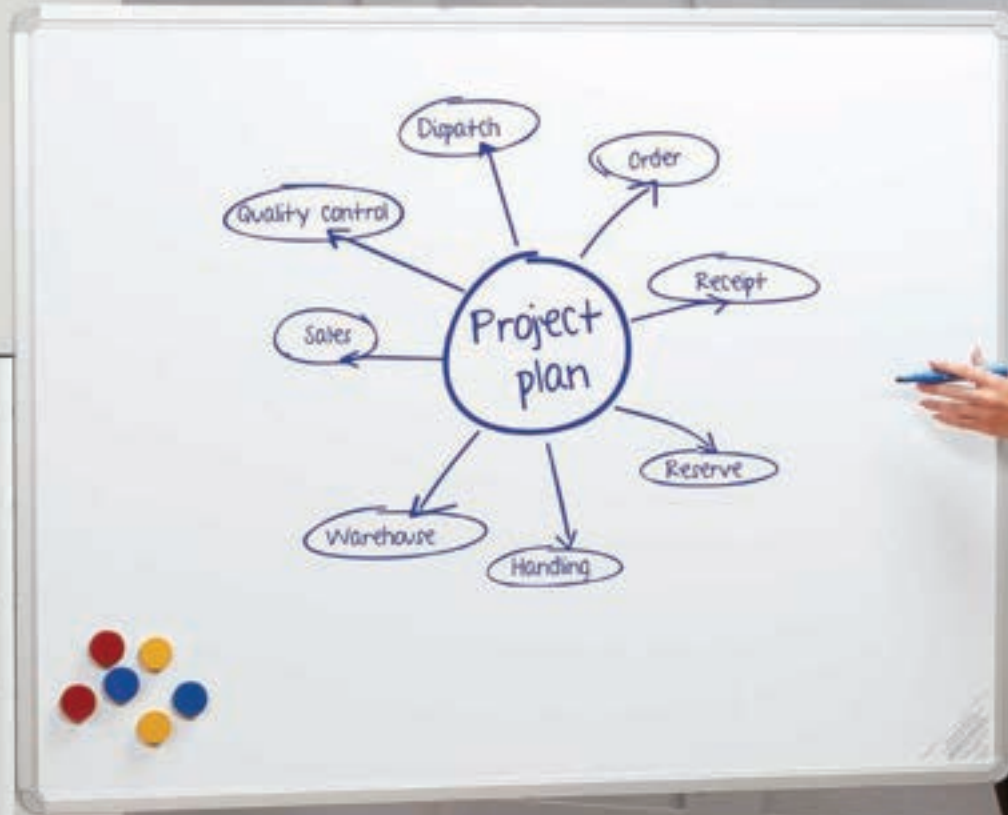

Writing Boards

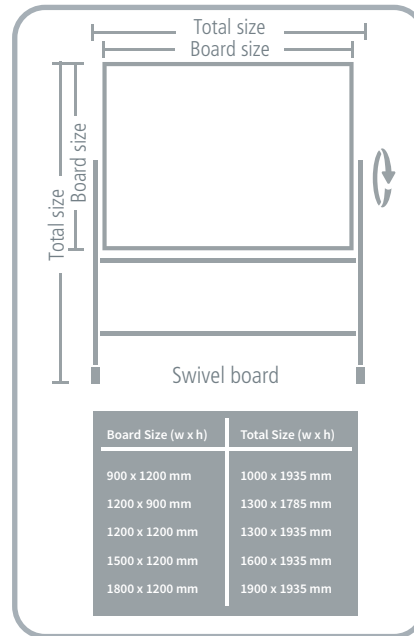

Mobile Swivel Writing Board

- Double-sided swivel board
- Magnetic: plain/plain surface, non-magnetic: plain/grid surface
- Rotates 360 degrees on the horizontal axis
- Tilt and lock in any position
- Mobile frame with locking castors and stability bar
- 5 year surface guarantee



Non-Magnetic Swivel Writing Board	Code	Price
900(w) X 1200mm(h) Portrait	1260	£171.00
1200(w) X 900mm(h) Landscape	1261	£171.00
1200(w) X 1200mm(h)	1262	£185.00
1500(w) X 1200mm(h) Landscape	1263	£203.00
1800(w) X 1200mm(h) Landscape	1264	£221.00

Magnetic Swivel Writing Board	Code	Price
900(w) X 1200mm(h) Portrait	1220	£236.00
1200(w) X 900mm(h) Landscape	1221	£236.00
1200(w) X 1200mm(h)	1222	£268.00
1500(w) X 1200mm(h) Landscape	1223	£287.00
1800(w) X 1200mm(h) Landscape	1224	£353.00



Mobile Pivot Writing Board

- Double-sided pivot board
- Magnetic: plain/plain surface, non-magnetic: plain/grid surface
- Assemble to rotate on either the vertical or horizontal axis
- Rotates 360 degrees in either direction
- Locks in any position
- Mobile frame with locking castors and stability bar
- 5 year surface guarantee



Non-Magnetic Pivot Writing Board	Code	Price
900(w) X 1200mm(h) Portrait	1280	£266.00
1200(w) X 900mm(h) Landscape	1281	£266.00
1200(w) X 1200mm(h)	1282	£302.00
1500(w) X 1200mm(h) Landscape	1283	£316.00
1800(w) X 1200mm(h) Landscape	1284	£352.00

Magnetic Pivot Writing Board	Code	Price
900(w) X 1200mm(h) Portrait	1275	£303.00
1200(w) X 900mm(h) Landscape	1276	£303.00
1200(w) X 1200mm(h)	1277	£331.00
1500(w) X 1200mm(h) Landscape	1278	£362.00
1800(w) X 1200mm(h) Landscape	1279	£412.00

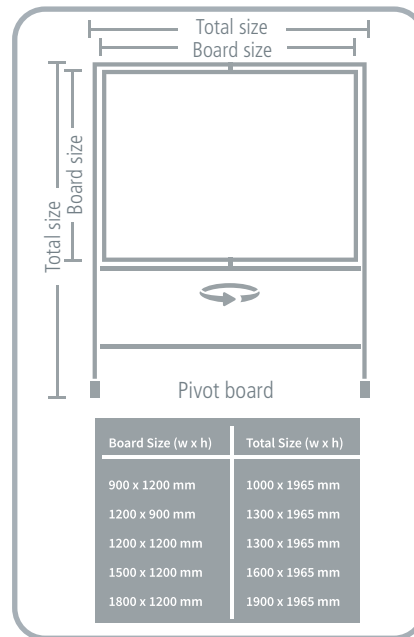

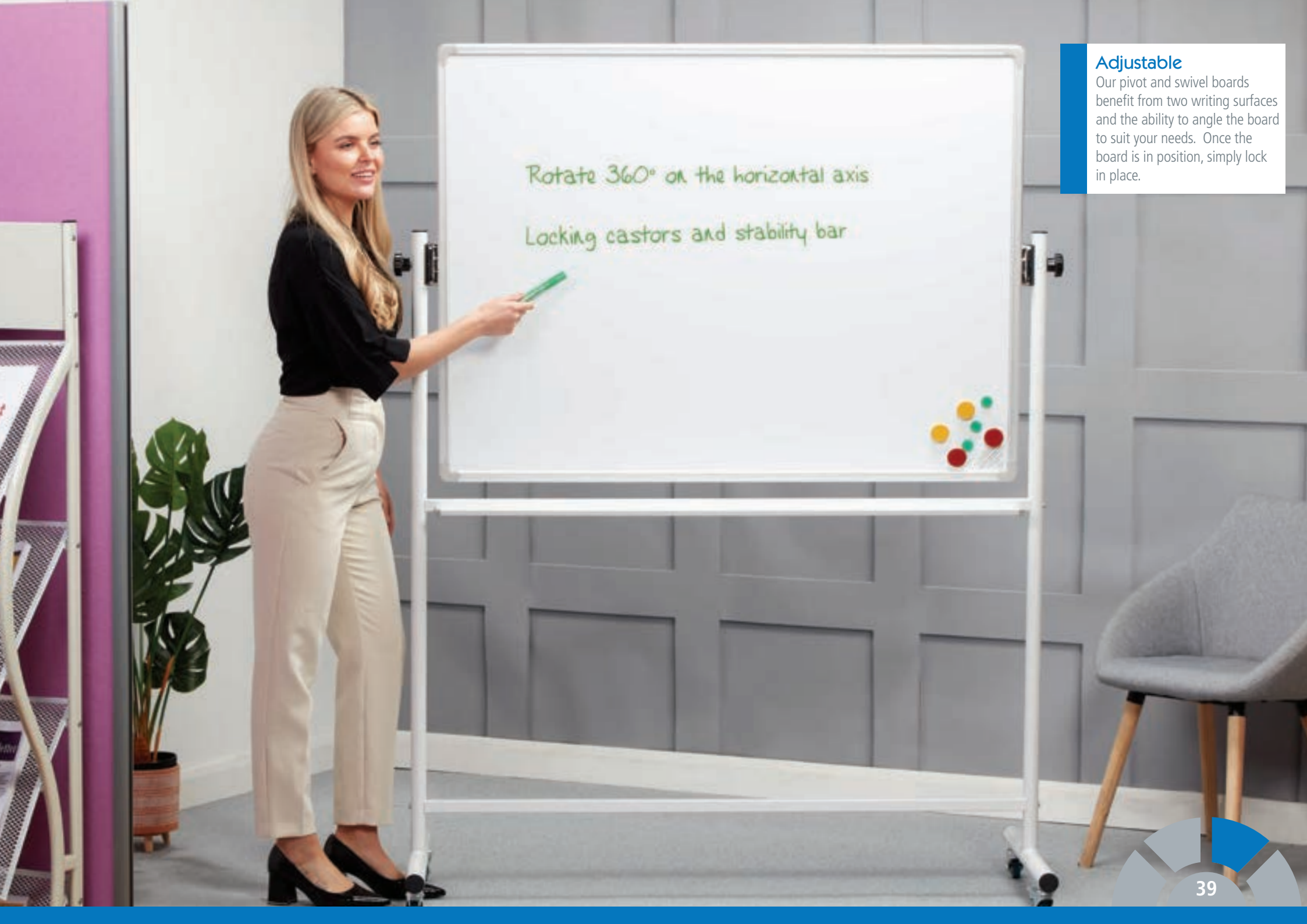

Adjustable

Our pivot and swivel boards benefit from two writing surfaces and the ability to angle the board to suit your needs. Once the board is in position, simply lock in place.

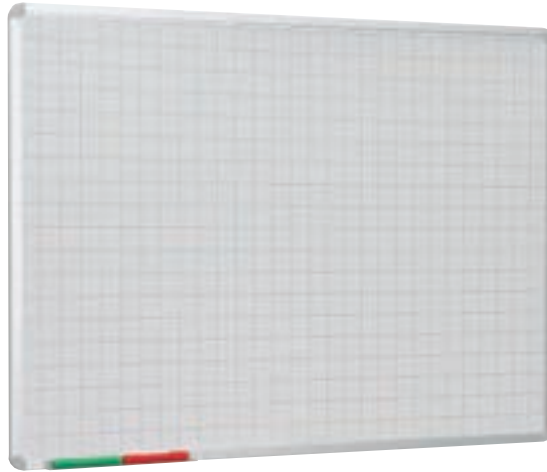

Non-Magnetic Square Writing Boards

- Writing board with 50mm squares
- Non-magnetic surface
- Perfect for teaching/training environments
- Satin silver anodised aluminium frame
- Rounded safety corners and concealed corner fixings
- Pen ledge and wall fixings included
- 5 year surface guarantee

Writing Board 50mm Squares	Code	Price
900(w) X 600mm(h)	0131G50	£122.00
1200(w) X 900mm(h)	0132G50	£127.00
1200(w) X 1200mm(h)	0133G50	£174.00
1500(w) X 1200mm(h)	0134G50	£199.00
1800(w) X 1200mm(h)	0136G50	£205.00
2400(w) X 1200mm(h)	0138G50	£300.00



Music Stave Writing Board

- Ideal for teaching
- Non-magnetic surface
- Satin silver anodised aluminium frame
- Rounded safety corners and concealed corner fixings
- Pen ledge and wall fixings included
- Size shown is 1200(w) X 1200mm(h)
- 5 year surface guarantee

Writing Board with Music Staves	Code	Price
900(w) X 600mm(h) (with 2 sets of staves)	0131M	£122.00
1200(w) X 900mm(h) (with 4 sets of staves)	0132M	£127.00
1200(w) X 1200mm(h) (with 5 sets of staves)	0133M	£174.00
1500(w) X 1200mm(h) (with 5 sets of staves)	0134M	£199.00
1800(w) X 1200mm(h) (with 5 sets of staves)	0136M	£205.00
2400(w) X 1200mm(h) (with 5 sets of staves)	0138M	£300.00



Non-Magnetic Lined Writing Boards

- Writing board with 75mm lines
- Non-magnetic surface
- Perfect for teaching/training environments
- Satin silver anodised aluminium frame
- Rounded safety corners and concealed corner fixings
- Pen ledge and wall fixings included
- 5 year surface guarantee

Writing Board 75mm Lines	Code	Price
900(w) X 600mm(h)	0131L75	£122.00
1200(w) X 900mm(h)	0132L75	£127.00
1200(w) X 1200mm(h)	0133L75	£174.00
1500(w) X 1200mm(h)	0134L75	£199.00
1800(w) X 1200mm(h)	0136L75	£205.00
2400(w) X 1200mm(h)	0138L75	£300.00



Magnetic Planners

- 3 printed design options: weekly, monthly and annual
- Magnetic board surface 900(w) x 600mm(h)
- Spacious layout for notes and key coding
- Satin silver anodised aluminium frame
- Rounded safety corners and concealed corner fixings
- Pen ledge and wall fixings included
- 5 year surface guarantee



Magnetic Writing Board

	Code	Price
Weekly Planner	95602	£71.00
Monthly Planner	95601	£71.00
Yearly Planner	95600	£71.00



Monthly planner

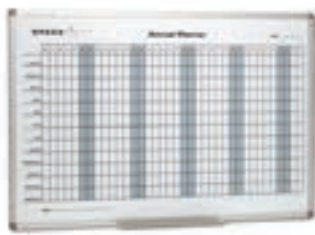

Annual planner



Organise
Whether it's organising dates or organising information, these writing boards help you to present information in a clear, concise and efficient manner.



Open position



Closed position

Spacesaving Writing Boards

- Folding writing board system designed to be space efficient
- Wings are double-sided to create additional writing areas
- Plain board surface with feint grid on the outside of wings
- Boards are available with either a single or double wing
- Non-magnetic surface
- Satin silver anodised aluminium frame
- Rounded safety corners and concealed corner fixings
- Pen ledge and wall fixings included
- 5 year surface guarantee



Closed size
600 x 900 mm
Open size
1200 x 900 mm
Single wing



Closed size
900 x 1200 mm
Open size
1800 x 1200 mm
Single wing



Closed size
1200 x 1200 mm
Open size
2400 x 1200 mm
Single wing



Closed size
1800 x 1200 mm
Open size
3600 x 1200 mm
Twin wings



Closed size
2400 x 1200 mm
Open size
4800 x 1200 mm
Twin wings

Please make sure you have enough space to accommodate the open wings as these boards will double in width when wings are open.
Minimum 1200mm clearance required from wall.

Spacesaving Writing Board	Code	Price
600(w) X 900mm(h) (Single Wing)	6120	£128.00
900(w) X 1200mm(h) (Single Wing)	6121	£170.00
1200(w) X 1200mm(h) (Single Wing)	6122	£235.00
1800(w) X 1200mm(h) (Twin Wings)	6182	£370.00
2400(w) X 1200mm(h) (Twin Wings)	6242	£434.00



Sliding detail

Sliding Writing Board System

- Sliding writing board system with non-magnetic surface
- Full back board with 1 or 2 sliding boards
- System fitted with 3 channels so sliding boards can overlap
- Nylon glides provide an easy sliding action
- White anodised aluminium frame
- Wall fixings included
- 5 year surface guarantee

Sliding Writing Board System (1 sliding board)	Code	Price
Writing space 3300(w) X 1200mm (h)		
2400(w) X 1200mm(h) Board Size	2790	£635.00

Sliding Writing Board System (2 sliding board)	Code	Price
Writing space 4200(w) X 1200mm (h)		
2400(w) X 1200mm(h) Board Size	2791	£643.00



Writing Board Accessories



Dry-wipe Pens

Size	Code	Price
Pk10 Black	DMPENSTBK10	£29.00
Pk10 Blue	DMPENSTBU10	£29.00
Pk10 Red	DMPENSTRD10	£29.00
Pk10 Green	DMPENSTGN10	£29.00



Board Cleaner

Size	Code	Price
250ml Spray	DWS.25	£20.00
1.0lt Bottle	DWC1	£22.00
2.5lt Bottle	DWC2.5	£40.00



Chalk Writing Boards

- Non-magnetic chalk writing board
- Satin silver anodised aluminium frame
- Rounded safety corners and concealed corner fixings
- Chalk ledge and wall fixings included
- Non-reflective surface
- Suitable for portrait or landscape use
- Boards are delivered pre-chalked in preparation for use
- 5 year surface guarantee

Chalk Writing Board	Code	Price
900(w) X 600mm(h)	1006	£63.00
1200(w) X 900mm(h)	1009	£102.00
1200(w) X 1200mm(h)	1012	£115.00
1500(w) X 1200mm(h)	1015	£119.00
1800(w) X 1200mm(h)	1018	£129.00
2400(w) X 1200mm(h)	1024	£152.00



Eco-friendly Chalk Writing Board

- Non-magnetic chalk writing board
- Light wood effect frame
- Constructed from a high proportion of recycled material
- Wall fixings included
- Non-reflective surface
- Suitable for portrait or landscape use
- Boards are delivered pre-chalked in preparation for use
- 5 year surface guarantee

Eco-friendly Chalk Writing Board	Code	Price
900(w) X 600mm(h)	1031	£66.00
1200(w) X 900mm(h)	1032	£93.00
1200(w) X 1200mm(h)	1033	£98.00
1500(w) X 1200mm(h)	1034	£130.00
1800(w) X 1200mm(h)	1035	£152.00
2400(w) X 1200mm(h)	1036	£160.00



Eco-friendly Writing Board

- Non-magnetic writing board
- Plain surface
- Light wood effect frame
- Constructed from a high proportion of recycled material
- Wall fixings included
- Suitable for portrait or landscape use
- 5 year surface guarantee

Eco-friendly Writing Board	Code	Price
900(w) X 600mm(h)	1850	£63.00
1200(w) X 900mm(h)	1851	£75.00
1200(w) X 1200mm(h)	1852	£79.00
1500(w) X 1200mm(h)	1853	£105.00
1800(w) X 1200mm(h)	1854	£105.00
2400(w) X 1200mm(h)	1855	£134.00



Writing Board Accessories

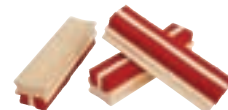

Chalk Duster

Size	Code	Price
Single	XLD	£13.00



Dry-wipe Pens

Size	Code	Price
Pk 4	DMPENSTASS4	£18.00



Chalk

Colour	Code	Price
White	CHLKOW100	£17.00
Assorted	CHLKOA100	£17.00

Notable

Allow your message to be the most prominent feature. Communicate in an effective manner, using one of these chalkboards. Pre-chalked in preparation for use and to make surface easier to clean.

Staff
Meeting 3pm



Wall Mounted Magnetic Glass Writing Board

- 4mm toughened safety glass
- 15 board colours to choose from
- 7 size options
- Contemporary chrome fixings
- Suitable for portrait or landscape use
- For best results use strong neodymium magnets
- Lifetime surface guarantee*

Wall Mounted Magnetic Glassboards	Code	Price
600(w) X 450mm(h)	GW4S	£193.00
900(w) X 600mm(h)	GW60	£250.00
1000(w) X 650mm(h)	GW6S	£260.00
1200(w) X 900mm(h)	GW90	£302.00
1200(w) X 1200mm(h)	GW12	£388.00
1500(w) X 1200mm(h)	GW15	£464.00
1800(w) X 1200mm(h)	GW18	£527.00



Customised Wall Mounted Magnetic Glass Writing Board

- 4mm toughened safety glass
- 15 board colours to choose from
- 7 size options
- Contemporary chrome fixings
- Suitable for portrait or landscape use
- For best results use strong neodymium magnets
- Fully customisable (see page 47 for details)
- Lifetime surface guarantee*

Customised Wall Mounted Glassboards	Code	Price
600(w) X 450mm(h)	GWP4S	£259.00
900(w) X 600mm(h)	GWP60	£322.00
1000(w) X 650mm(h)	GWP6S	£344.00
1200(w) X 900mm(h)	GWP90	£429.00
1200(w) X 1200mm(h)	GWP12	£493.00
1500(w) X 1200mm(h)	GWP15	£577.00
1800(w) X 1200mm(h)	GWP18	£685.00

Colour Options



Introduce a splash of colour with our stylish, magnetic, glass writing boards.

Made from recycled 4mm toughened safety glass with polished edges, these boards provide a durable, premium quality writing surface for presenting information.

The contemporary design makes an impressive visual impact and offers a refined alternative to conventional dry-wipe boards.

Our wall mounted glassboards are available in a variety of colours with the option to customise your board.

- Stylish and contemporary design
- Magnetic surface for use with strong magnets
- Easy to clean with dry-wipe eraser
- Lifetime surface guarantee*



Frameless finish



Chrome fixings

Customise Your Glass Writing Board

Add a personal touch to any of the glass boards in our range. All you have to do is place your order and send us your logo. We will then contact you to discuss your requirements and agree a design brief. A proof will be sent for approval before print. From approval, the product lead time will be approximately 4 weeks.

Please note all customised glassboards are non-returnable.

White'n Wipe
Glassboards

* Does not include accidental damage or misuse



Polished

With a frameless finish and polished edges, our glass boards are safe for use in an office or education environment.

Boards can be fitted side by side to create a larger writing area.



Wall Mounted Rollerboard Frame

- Perfect solution for smaller spaces
- Sturdy, durable, traditional construction
- Light wood melamine MDF frame
- Writing surfaces can be replaced as required
- Wall fixings included
- Select 3 section surface options below

Wall Mounted Rollerboard Frame	Code	Price
1200(w) X 1800mm(h) 3 section surface	3226	£439.00
1800(w) X 1200mm(h) 3 section surface	3227	£550.00

Surface options for 3226 (choose 3)	Code	Price
Plain White	SEC3226P	£74.00
Ruled 50mm Squares	SEC322650S	£100.00
Ruled 75mm Lines	SEC322675L	£100.00
Feint Grid	SEC3226WD	£105.00

Surface options for 3227 (choose 3)	Code	Price
Plain White	SEC3227P	£105.00
Ruled 50mm Squares	SEC322750S	£165.00
Ruled 75mm Lines	SEC322775L	£165.00
Feint Grid	SEC3227WD	£173.00



Floor Standing Wall Fixed Rollerboard Frame

- Select 3 or 4 section surface options below
- Sturdy, durable, traditional construction
- Floor standing but fixed to wall (fixings included)
- Light wood melamine MDF frame
- Writing surfaces can be replaced as required
- Suitable for large classrooms/teaching environments

Floor Standing Rollerboard Frame	Code	Price
1500(w) X 2300mm(h) 3 section surface	3220	£413.00
1800(w) X 2300mm(h) 3 section surface	3221	£462.00
2400(w) X 2300mm(h) 3 section surface	3222	£520.00
1500(w) X 2300mm(h) 4 section surface	3223	£420.00
1800(w) X 2300mm(h) 4 section surface	3224	£493.00
2400(w) X 2300mm(h) 4 section surface	3225	£570.00

Surface options for 3220 (choose 3)	Code	Price
Plain White	SEC3220P	£90.00
Ruled 50mm Squares	SEC322050S	£136.00
Ruled 75mm Lines	SEC322075L	£136.00
Feint Grid	SEC3220WD	£139.00

Surface options for 3221 (choose 3)	Code	Price
Plain White	SEC3221P	£108.00
Ruled 50mm Squares	SEC322150S	£168.00
Ruled 75mm Lines	SEC322175L	£168.00
Feint Grid	SEC3221WD	£176.00

Surface options for 3222 (choose 3)	Code	Price
Plain White	SEC3222P	£131.00
Ruled 50mm Squares	SEC322250S	£216.00
Ruled 75mm Lines	SEC322275L	£216.00
Feint Grid	SEC3222WD	£228.00

Surface options for 3223 (choose 4)	Code	Price
Plain White	SEC3223P	£90.00
Ruled 50mm Squares	SEC322350S	£136.00
Ruled 75mm Lines	SEC322375L	£136.00
Feint Grid	SEC3223WD	£139.00

Surface options for 3224 (choose 4)	Code	Price
Plain White	SEC3224P	£108.00
Ruled 50mm Squares	SEC322450S	£168.00
Ruled 75mm Lines	SEC322475L	£168.00
Feint Grid	SEC3224WD	£176.00

Surface options for 3225 (choose 4)	Code	Price
Plain White	SEC3225P	£131.00
Ruled 50mm Squares	SEC322550S	£216.00
Ruled 75mm Lines	SEC322575L	£216.00
Feint Grid	SEC3225WD	£228.00



Mobile Rollerboard Frame

- Suitable for small classrooms/teaching environments
- Sturdy, durable, traditional construction
- Light wood melamine MDF frame
- Writing surfaces can be replaced as required
- 4 heavy-duty castors
- Select 3 section surface options below

Mobile Rollerboard Frame	Code	Price
1200(w) X 1800mm(h) 3 section surface	3228	£485.00
1500(w) X 2300mm(h) 3 section surface	3229	£570.00

Surface options for 3228 (choose 3)	Code	Price
Plain White	SEC3228P	£65.00
Ruled 50mm Squares	SEC322850S	£86.00
Ruled 75mm Lines	SEC322875L	£86.00
Feint Grid	SEC3228WD	£90.00

Surface options for 3229 (choose 3)	Code	Price
Plain White	SEC3229P	£90.00
Ruled 50mm Squares	SEC322950S	£136.00
Ruled 75mm Lines	SEC322975L	£136.00
Feint Grid	SEC3229WD	£139.00



Revolving

For over 100 years rollerboards have played a pivotal role in education and are a familiar feature in most classrooms and lecture theatres.





Replacement Sections

- Our sections are suitable for any make of rollerboard and can be replaced as required
- Choose from plain, feint grid, 50mm square or 75mm lines
- Writing sections are easy to fit and fitting instructions are provided, however, a fitting service is available (price on request)
- All sections carry a 1 year surface guarantee*

Replacement Plain White Sections

Width up to	Code	Price
1200mm(w)	9012	£105.00
1500mm(w)	9016	£129.00
1800mm(w)	9019	£145.00
2400mm(w)	9025	£182.00

Replacement Ruled and Feint Grid Sections

Width up to	Code	Price
1200mm(w)	9112	£147.00
1500mm(w)	9116	£170.00
1800mm(w)	9119	£186.00
2400mm(w)	9125	£224.00

Request an Inspection

If you have a requirement for new rollerboard surfaces, or need help assessing the condition of your current board surfaces, we can help.

Our qualified service team will visit to inspect your boards and provide a recommendation report on any maintenance/replacements required.

To book an inspection please call:

0845 6017619

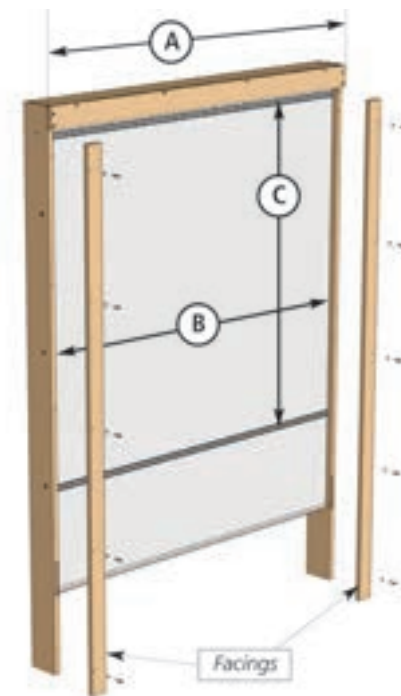

Measuring Guide

To enable us to supply replacement writing sections made exactly to your requirements, we require the following key information:

1. Overall board width, including frame - A
2. Overall section width - B
3. Section height between connecting strip centres - C
4. Writing surface type required for each section
5. If fitting is required, please also supply the location of the rollerboard e.g. Science lab

Flip Chart Easels

Easels are the quick, easy and efficient solution for presenting information to an audience.

Whether it's for brainstorming, training, teaching or meetings, our range of easels are designed to suit different requirements.

Mobile easels are perfect for moving from room to room and positioning close to the audience, whilst tripod and loop leg easels are ideal for storing away after use.

Our easel features include:

- Strong, sturdy construction
- High-quality and dry-wipe surface
- Height adjustable for flexibility
- Integrated flip chart clamp and pen ledge
- Magnetic and non-magnetic surface options

SPACERIGHT
europe ltd

spacerighteurope.com



Flip Chart Easels



SPACERIGHT
europe ltd

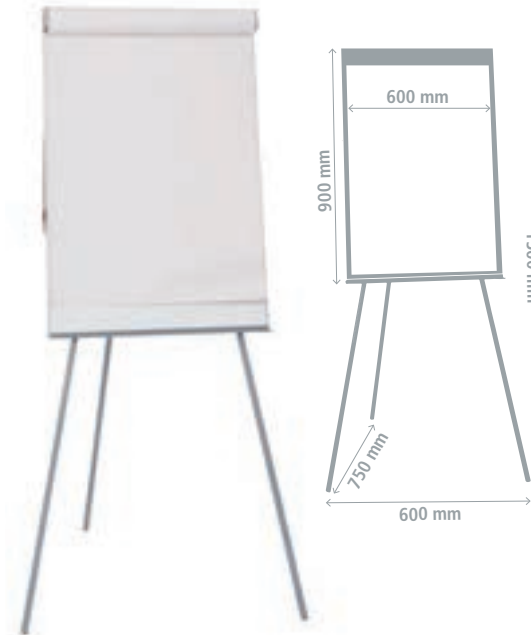

Non-Magnetic Telescopic Flip Chart Easel

- Non-magnetic dry-wipe surface
- 600(w) x 900mm(h) surface area
- Sturdy metal construction
- Telescopic leg design for easy storage
- Height adjustable by 700mm
- Foot print 600(w) x 750mm(d)
- Flip chart clamp (holds pads up to A1 size)
- Pen ledge
- 1 year surface guarantee

Non-Magnetic Flip Chart Easel	Code	Price
600(w) X 1500mm(h)	3500	£79.00



Step 1



Fold out rear leg and click rear leg extension into place

Step 2



Pull down front leg extensions and click into place

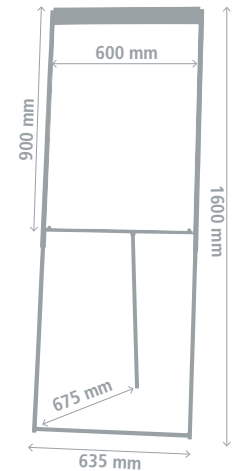

2 Clix Easel

- Non-magnetic dry-wipe surface
- 600(w) x 900mm(h) surface area
- Simple two step operation
- No assembly required
- Incredibly stable metal construction
- Folds for easy storage
- Height adjustable to 3 preset heights
- Foot print 635(w) x 675mm(d)
- Flip chart clamp (holds pads up to A1 size)
- Full length pen ledge
- 2 colour options to choose from
- 1 year surface guarantee

Tripod 2 Clix Easel	Code	Price
635(w) X 1600mm(h) Blue	95015	£91.00
635(w) X 1600mm(h) Red	95016	£91.00

Colour Options (2 Clix Easel)

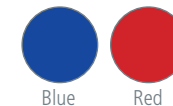

Blue

Red

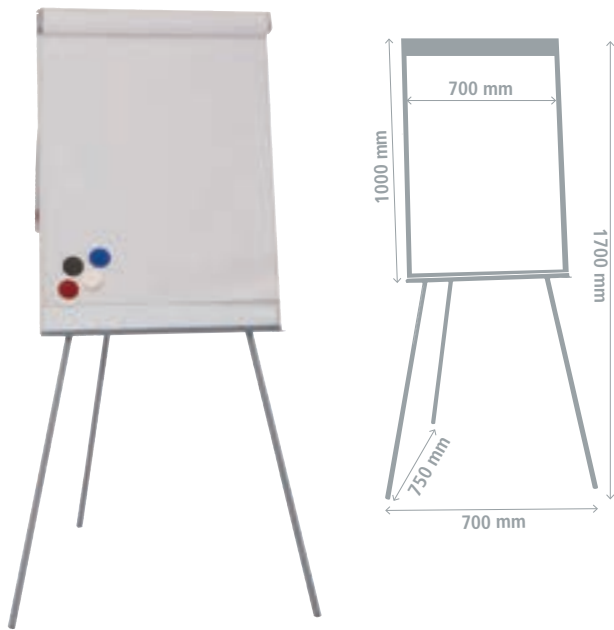

Magnetic Telescopic Flip Chart Easel

- Magnetic dry-wipe surface
- 700(w) x 1000mm(h) surface area
- Sturdy metal construction
- Telescopic leg design for easy storage
- Height adjustable by 700mm
- Foot print 700(w) x 750mm(d)
- Flip chart clamp (holds pads up to A1 size)
- Pen ledge
- 1 year surface guarantee



Magnetic Telescopic Flip Chart Easel	Code	Price
700(w) X 1700mm(h)	95010	£105.00

Writing Board Accessories

Dusters			Dry-wipe Pens		
Size	Code	Price	Size	Code	Price
Single	WBERAS1	£18.00	Pk 4	DMPENSTASS4	£18.00
Pk12	WBERAS12	£46.00			



Flip Chart Easels



SPACERIGHT
europe ltd

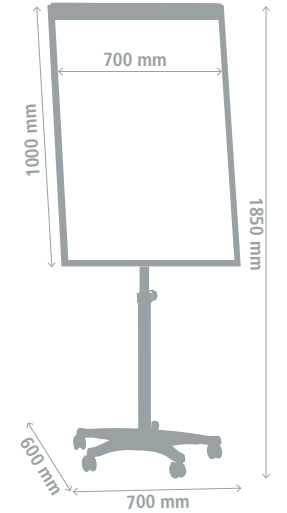
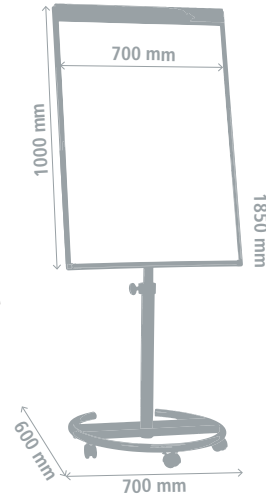

Mobile Round Base Easel

- Choose from magnetic or non-magnetic surface
- 700(w) x 1000mm(h) surface area
- Height adjustable by 250mm
- Complete with side bars for displaying multiple sheets (3 x A1)
- Sturdy mobile base with 5 locking castors
- Foot print 700(w) x 600mm(d)
- Flip chart clamp (holds pads up to A1 size)
- Pen ledge
- White frame
- 1 year surface guarantee

Mobile Star Base Easel

- Choose from magnetic or non-magnetic surface
- 700(w) x 1000mm(h) surface area
- Height adjustable by 250mm
- Complete with side bars for displaying multiple sheets (3 x A1)
- Sturdy mobile star base with 5 locking castors
- Foot print 700(w) x 600mm(d)
- Flip chart clamp (holds pads up to A1 size)
- Pen ledge
- Black frame
- 1 year surface guarantee

Mobile Round Base Easel	Code	Price
700(w) X 1850mm(h) Non-magnetic	95111	£140.00
700(w) X 1850mm(h) Magnetic	95001	£164.00

Mobile Star Base Easel	Code	Price
700(w) X 1850mm(h) Non-magnetic	95333	£151.00
700(w) X 1850mm(h) Magnetic	95003	£168.00



Ultramate Magnetic Round Base Flip Chart Easel

- Magnetic dry-wipe surface
- 700(w) x 1000mm(h) surface area
- Height adjustable by 250mm
- Sturdy mobile base with 5 locking castors
- Foot print 700(w) x 600mm(d)
- Flip chart clamp (holds pads up to A1 size)
- Pen ledge
- 6 colour options to choose from
- 1 year surface guarantee

Magnetic Round Base Ultramate Easel	Code	Price
700(w) X 1850mm(h) Black	95001BLK	£149.00
700(w) X 1850mm(h) Blue	95001BL	£149.00
700(w) X 1850mm(h) Red	95001R	£149.00
700(w) X 1850mm(h) Green	95001GRN	£149.00
700(w) X 1850mm(h) White	95001WH	£149.00
700(w) X 1850mm(h) Grey	95001GRY	£149.00

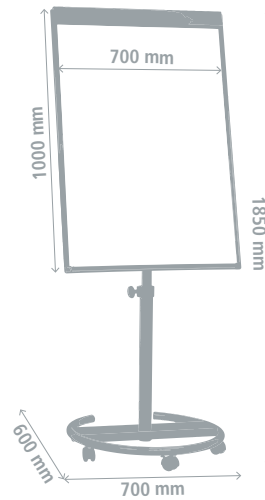

Colour Options (Ultramate Round Base)

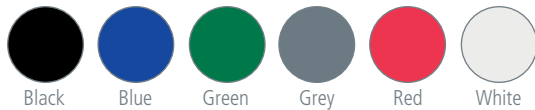

Flip Chart Easels

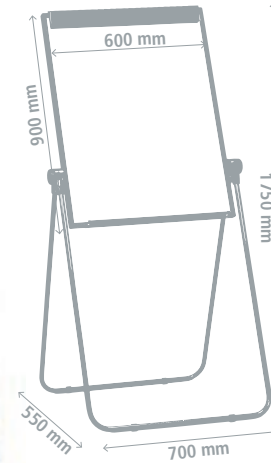

Ultramate Magnetic Loop Leg Flip Chart Easel

- Double-sided, magnetic dry-wipe surface
- Lightweight yet sturdy construction
- 600(w) x 900mm(h) surface area
- Height adjustable by 700mm
- Surface tilts and rotates for ease of use
- Foot print 700(w) x 550mm(d)
- Flip chart clamp (holds pads up to A1 size)
- Pen ledge on one side
- 6 colour options to choose from
- 1 year surface guarantee



Ultramate Magnetic Loop Leg Easel	Code	Price
700(w) X 1750mm(h) Black	95006	£116.00
700(w) X 1750mm(h) Blue	95007	£116.00
700(w) X 1750mm(h) Red	95008	£116.00
700(w) X 1750mm(h) Green	95009GRN	£116.00
700(w) X 1750mm(h) White	95009WH	£116.00
700(w) X 1750mm(h) Grey	95009GRY	£116.00

Colour Options (Ultramate Loop Leg)

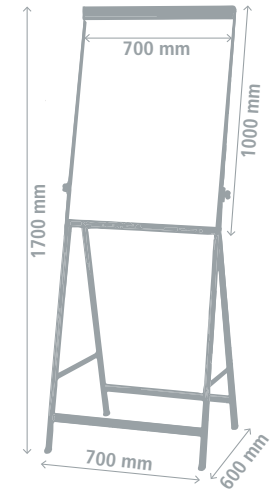

Magnetic Conference Easel

- Magnetic writing board surface
- Designed for high performance
- High-quality aluminium frame
- 700(w) x 1000mm(h) surface area
- Height adjustable by 765mm
- Foot print 700(w) x 600mm(d)
- Legs interlock for easy carrying and storage
- Flip chart clamp (holds pads up to A1 size)
- Full length pen ledge
- 3 year surface guarantee



Magnetic Conference Easel	Code	Price
700(w) X 1700mm(h)	95014	£343.00

Writing Board Accessories



Dusters

Size	Code	Price
Single	WBERAS1	£18.00
Pk12	WBERAS12	£46.00



Dry-wipe Pens

Size	Code	Price
Pk 4	DMPENSTASS4	£18.00

WeatherShield Showcases & Signage

Present your information in a professional manner with the WeatherShield showcase and signage range.

For ease of use and hassle-free changing of information, each showcase features gas strut assisted doors that will remain in position when opened. The double locking system and virtually shatterproof glazing ensures that information within the showcase is safe and secure.

All WeatherShield showcases and signs are:

- Made from strong, durable aluminium
- Suitable for a variety of institutions including schools, universities, nurseries and more
- Available with free personalisation to allow you to convey your identity to staff, pupils and visitors

SPACERIGHT
europe ltd

spacerighteurope.com



WeatherShield Showcases



SPACERIGHT
europe ltd



WeatherShield Wall Mounted Outdoor Showcase

- Display information outdoors to visitors, staff and pupils
- Double seal and fully enclosed case protects from the elements
- IP55 certified (dust and water ingress)
- Virtually shatterproof PETG glazing
- Safe and secure double locking system
- Features gas strut assisted doors
- Internal clearance between door and board is 40mm
- Choose from 7 colour options with aluminium frame or 4 colour options with powder coated frame
- Wall fixings included
- Made in the UK
- 2 year product guarantee

WeatherShield Wall Mounted Showcase	Code	Price
742(w) X 555mm(h) (4xA4 Landscape)	7201	£314.00
560(w) X 735mm(h) (4xA4 Portrait)	7202	£314.00
1005(w) X 735mm(h) (8xA4)	7203	£342.00
780(w) X 1031mm(h) (9xA4)	7204	£376.00
1005(w) X 1031mm(h) (12xA4)	7205	£432.00
1220(w) X 1031mm(h) (15xA4)	7206	£459.00
1423(w) X 1031mm(h) (18xA4)	7207	£494.00



WeatherShield Freestanding Outdoor Showcase

- Display information outdoors to visitors, staff and pupils
- Choose from sunken or surface mounted posts
- Supplied with 2 x 2400mm grey powder coated aluminium posts
- Double seal and fully enclosed case protects from the elements
- IP55 certified (dust and water ingress)
- Virtually shatterproof PETG glazing
- Safe and secure double locking system
- Features gas strut assisted doors
- Internal clearance between door and board is 40mm
- Choose from 7 colour options with aluminium frame or 4 colour options with powder coated frame
- Made in the UK
- 2 year product guarantee

Freestanding Showcase (Sunken Posts)	Code	Price
780(w) X 1031mm(h) (9xA4)	7401	£651.00
1005(w) X 1031mm(h) (12xA4)	7402	£694.00
1220(w) X 1031mm(h) (15xA4)	7403	£717.00
1423(w) X 1031mm(h) (18xA4)	7404	£789.00

Freestanding Showcase (Surface Posts)	Code	Price
780(w) X 1031mm(h) (9xA4)	7411	£881.00
1005(w) X 1031mm(h) (12xA4)	7412	£903.00
1220(w) X 1031mm(h) (15xA4)	7413	£960.00
1423(w) X 1031mm(h) (18xA4)	7414	£1,029.00

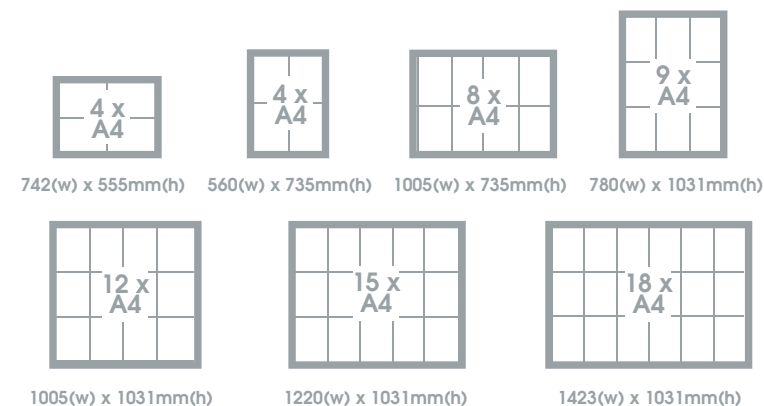

Surface brackets

For fitting instructions please see page 64.



Aluminium Frame Colour Options (Felt)



Powder Coated Frame Colour Options (Frame and Felt)



Mix and match colour options are available on a non-refundable basis

Impress

First impressions count. The WeatherShield showcase and signage range delivers your information to visitors, staff and pupils, in a professional and eye-catching manner.



WeatherShield Contour



SPACERIGHT
europe ltd



WeatherShield Contour Wall Mounted Outdoor Sign

- Personalised outdoor sign with name, logo or crest and footer text*
- Double seal and fully enclosed showcase protects from the elements
- IP55 certified (dust and water ingress)
- Virtually shatterproof PETG glazing
- Safe and secure double locking system
- Features gas strut assisted doors
- Internal clearance between door and board is 40mm
- 5 colour options to choose from
- Wall fixings included
- 2 year product guarantee

WeatherShield Contour Outdoor Sign	Code	Price
750(w) X 1000mm(h) (4xA4 Landscape)	7480	£778.00
750(w) X 1000mm(h) (4xA4 Portrait)	7481	£778.00
1100(w) X 1400mm(h) (8xA4)	7482	£864.00
1100(w) X 1400mm(h) (9xA4)	7483	£918.00
1500(w) X 1400mm(h) (12xA4)	7408	£983.00
1500(w) X 1400mm(h) (15xA4)*	7484	£1,071.00
1500(w) X 1400mm(h) (18xA4)*	7485	£1,144.00

Colour Options (Frame and Felt)



Please note the aluminium framed showcase has a blue backing panel as standard.



WeatherShield Contour Freestanding Outdoor Sign

- Personalised outdoor sign with name, logo or crest and footer text*
- Choose from sunken or surface mounted posts
- Supplied with 2 x 2400mm grey powder coated aluminium posts
- Double seal and fully enclosed showcase protects from the elements
- IP55 certified (dust and water ingress)
- Virtually shatterproof PETG glazing
- Safe and secure double locking system with gas strut assisted doors
- Internal clearance between door and board is 40mm
- 5 colour options to choose from
- 2 year product guarantee

Freestanding Contour Sign (Sunken Posts)	Code	Price
750(w) X 1000mm(h) (4xA4 Landscape)	7450	£996.00
750(w) X 1000mm(h) (4xA4 Portrait)	7451	£996.00
1100(w) X 1400mm(h) (8xA4)	7452	£1,082.00
1100(w) X 1400mm(h) (9xA4)	7453	£1,134.00
1500(w) X 1400mm(h) (12xA4)	7406	£1,200.00
1500(w) X 1400mm(h) (15xA4)*	7454	£1,288.00
1500(w) X 1400mm(h) (18xA4)*	7455	£1,362.00

Personalisation

WeatherShield Contour signs are personalised free of charge with your business/institution name, logo or crest and footer text*. Simply select the size and colour required, then place your order. We will then contact you to confirm the details and request any artwork you may have. A proof will be supplied prior to print and the lead time is 4 weeks from artwork approval. All artwork is applied to the sign in waterproof vinyl. If you have any queries, please contact us on 0845 6017619.

Please note all personalised WeatherShield signs are non-returnable.



* Footer text is not possible on 15 x A4 and 18 x A4 sizes



Surface brackets

For fitting instructions please see page 64.

Freestanding Contour Sign (Surface Posts)	Code	Price
750(w) X 1000mm(h) (4xA4 Landscape)	7460	£1,213.00
750(w) X 1000mm(h) (4xA4 Portrait)	7461	£1,213.00
1100(w) X 1400mm(h) (8xA4)	7462	£1,299.00
1100(w) X 1400mm(h) (9xA4)	7463	£1,352.00
1500(w) X 1400mm(h) (12xA4)	7416	£1,417.00
1500(w) X 1400mm(h) (15xA4)*	7464	£1,506.00
1500(w) X 1400mm(h) (18xA4)*	7465	£1,582.00



Promote

The WeatherShield Contour range effectively combines signage and display, allowing you to present information outdoors, whilst promoting your school, university, college or business identity.

WeatherShield Headline



SPACERIGHT
europe ltd



WeatherShield Headline Wall Mounted Outdoor Sign

- Personalised outdoor sign with name
- Double seal and fully enclosed showcase protects from the elements
- IP55 certified (dust and water ingress)
- Name plate is 250mm high
- Virtually shatterproof PETG glazing
- Safe and secure double locking system
- Features gas strut assisted doors
- Internal clearance between door and board is 40mm
- 5 colour options to choose from
- Wall fixings included
- Made in the UK
- 2 year product guarantee

WeatherShield Headline Outdoor Sign	Code	Price
780(w) X 1281mm(h) (9xA4) single door	7472	£740.00
1005(w) X 1281mm(h) (12xA4) single door	7473	£802.00
1220(w) X 1281mm(h) (15xA4) single door	7474	£845.00
1423(w) X 1281mm(h) (18xA4) single door	7475	£953.00
1570(w) X 1281mm(h) (18xA4) double door	7476	£1,166.00

Colour Options (Frame and Felt)



Please note the aluminium framed showcase has a blue name panel as standard.



WeatherShield Headline Freestanding Outdoor Sign

- Personalised outdoor sign with name
- Choose from sunken or surface mounted posts
- Supplied with 2 x 2400mm grey powder coated aluminium posts
- Double seal and fully enclosed showcase protects from the elements
- IP55 certified (dust and water ingress)
- Name plate is 250mm high
- Virtually shatterproof PETG glazing
- Safe and secure double locking system
- Features gas strut assisted doors
- Internal clearance between door and board is 40mm
- 5 colour options to choose from
- Made in the UK
- 2 year product guarantee

Freestanding Headline Sign (Sunken Posts)	Code	Price
780(w) X 1281mm(h) (9xA4) single door	7432	£953.00
1005(w) X 1281mm(h) (12xA4) single door	7433	£1,016.00
1220(w) X 1281mm(h) (15xA4) single door	7434	£1,059.00
1423(w) X 1281mm(h) (18xA4) single door	7435	£1,166.00
1570(w) X 1281mm(h) (18xA4) double door	7436	£1,486.00

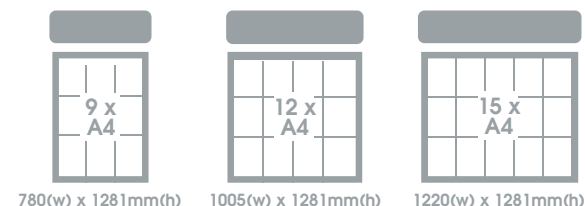

780(w) x 1281mm(h) 1005(w) x 1281mm(h) 1220(w) x 1281mm(h)

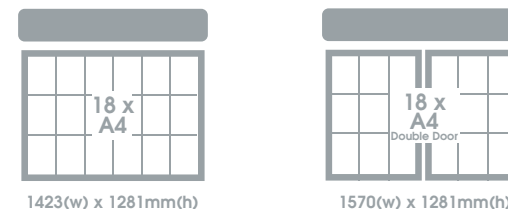

1423(w) x 1281mm(h) 1570(w) x 1281mm(h)



Surface brackets



Post fitment

For fitting instructions please see page 66.

Freestanding Headline Sign (Surface Posts)	Code	Price
780(w) X 1281mm(h) (9xA4) single door	7442	£1,166.00
1005(w) X 1281mm(h) (12xA4) single door	7443	£1,229.00
1220(w) X 1281mm(h) (15xA4) single door	7444	£1,273.00
1423(w) X 1281mm(h) (18xA4) single door	7445	£1,379.00
1570(w) X 1281mm(h) (18xA4) double door	7446	£1,806.00

Personalisation

WeatherShield Headline signs are personalised free of charge with your business/institution name. Simply select the size and colour required, then place your order. We will then contact you to confirm the details. A proof will be supplied prior to print and the lead time is 4 weeks from artwork approval. All artwork is applied to the sign in waterproof vinyl. If at any point you have any queries, please contact us on 0845 6017619. **Please note all personalised WeatherShield signs are non-returnable.**

Protect

WeatherShield Headline signage is perfect for displaying notices outdoors in a safe and secure environment. Information is protected from the elements in a waterproof showcase.

Langland Community School



WeatherShield Showcase



SPACERIGHT
europe ltd



WeatherShield Wall Mounted Magnetic Outdoor Showcase

- Display handwritten information or notices outdoors
- Magnetic dry-wipe surface
- Double seal and fully enclosed case protects from the elements and is IP55 certified
- Virtually shatterproof PETG glazing
- Safe and secure double locking system
- Features gas strut assisted door
- Internal clearance between door and board is 40mm
- 5 colour options to choose from
- Wall fixings included
- Made in the UK
- 2 year product guarantee



WeatherShield Magnetic Showcase

Code	Price
742(w) X 555mm(h)	7221 £329.00
560(w) X 735mm(h)	7222 £329.00
1005(w) X 735mm(h)	7223 £373.00
780(w) X 1031mm(h)	7224 £397.00
1005(w) X 1031mm(h)	7225 £428.00
1220(w) X 1031mm(h)	7226 £450.00
1423(w) X 1031mm(h)	7227 £515.00

Colour Options (Frame)

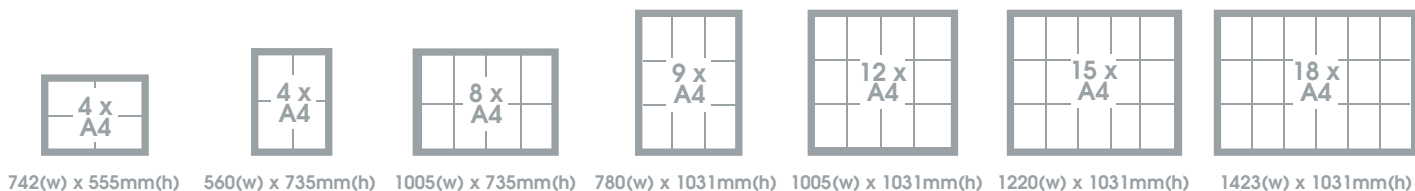

WeatherShield Fitting Instructions

- All WeatherShield showcases and signage products are supplied with full fitting instructions
- Wall Mounted WeatherShield products are supplied with wall fixings
- Surface mounted WeatherShield products are supplied with two brackets that need to be fixed to a preformed concrete base (600mm deep)
- Sunken post WeatherShield products should be installed 600mm deep into ground and filled with postcrete

Installation for WeatherShield showcase and signage products is available separately by quotation.
For further information, please contact us on 0845 6017619.

Fire Retardant Noticeboards

FlameShield is the market leading brand in fire retardant noticeboards.

The FlameShield noticeboard core and bonded textile are fire retardant as a composite, meeting Class 0 when assessed to BS 476 Parts 6 and 7 and comply with Class B-s1, d0 when tested to BS-EN13501-1: 2002.

The range benefits from:

- Unframed, aluminium framed and tamperproof boards
- Various colour and size options to suit all requirements
- High-quality manufacturing
- UK made

For further information on suitable use of these boards, please see pg. 74.

SPACERIGHT
europe ltd
spacerighteurope.com



Flame  Shield

Fire Retardant Noticeboards

FlameShield



SPACE RIGHT
europe ltd



FlameShield Unframed Noticeboard

- Noticeboard core and bonded textile are fire retardant as a composite, meeting Class 0 when assessed to BS 476 Parts 6 and 7, and comply with Class B-s1, d0 when tested to BS-EN13501-1: 2002
- Wrapped over edges are fixed on reverse
- Suitable for pins and staples
- Ideal for portrait or landscape use
- Wall fixings included
- 7318H and 7324H are supplied in two parts
- 5 colours to choose from
- 2 year product guarantee

FlameShield Aluminium Framed Noticeboard

- Noticeboard core and bonded textile are fire retardant as a composite, meeting Class 0 when assessed to BS 476 Parts 6 and 7, and comply with Class B-s1, d0 when tested to BS-EN13501-1: 2002
- Satin silver anodised aluminium frame
- Rounded safety corners and concealed corner fixings
- Suitable for pins and staples
- Ideal for portrait or landscape use
- Wall fixings included
- 5 colours to choose from
- 2 year product guarantee

FlameShield Tamperproof Noticeboard

- Noticeboard core and bonded textile are fire retardant as a composite, meeting Class 0 when assessed to BS 476 Parts 6 and 7, and comply with Class B-s1, d0 when tested to BS-EN13501-1: 2002
- The clear plastic doors are tested separately and conform to Class 1Y when assessed to BS 476 Part 7
- Satin silver anodised aluminium frame with rounded safety corners
- Top hinged models have stays to hold doors open (landscape use only)
- Single door models are suitable for portrait or landscape use
- Double door models are suitable for landscape use only
- Internal clearance is 20mm
- Suitable for pins/staples and wall fixings included
- 5 colours to choose from
- 2 year product guarantee



FlameShield Unframed Noticeboard	Code	Price
900(w) X 600mm(h)	7306H	£60.00
1200(w) X 900mm(h)	7309H	£88.00
1200(w) X 1200mm(h)	7312H	£105.00
1500(w) X 1200mm(h)	7315H	£136.00
1800(w) X 600mm(h)	7317H	£115.00
1800(w) X 1200mm(h) (2 boards 1200 x 900mm)	7318H	£158.00
2400(w) X 1200mm(h) (2 boards 1200 x 1200mm)	7324H	£191.00

FlameShield Framed Noticeboard	Code	Price
900(w) X 600mm(h)	4806H	£65.00
1200(w) X 900mm(h)	4809H	£93.00
1200(w) X 1200mm(h)	4812H	£117.00
1500(w) X 1200mm(h)	4815H	£141.00
1800(w) X 1200mm(h)	4818H	£163.00
2400(w) X 1200mm(h)	4824H	£212.00

FlameShield Side Hinged Noticeboard	Code	Price
600(w) X 900mm(h)	5006H	£164.00
900(w) X 1200mm(h)	5009H	£232.00
1200(w) X 1200mm(h)	5012H	£287.00
1800(w) X 1200mm(h)	5018H	£434.00
2400(w) X 1200mm(h)	5024H	£510.00

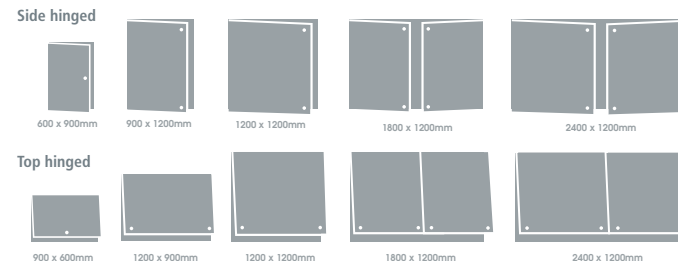

Colour Options



For fire regulation information, please see page 74.



Safety

FlameShield noticeboards are engineered to last and designed to meet the required standards. As a result, you will find they are heavier, robust and more dense than a standard noticeboard.

Fire Retardant Noticeboards



Accents FlameShield Unframed Noticeboard

- Noticeboard core and bonded textile are fire retardant as a composite, meeting Class 0 when assessed to BS 476 Parts 6 and 7, and comply with Class B-s1, d0 when tested to BS-EN13501-1: 2002
- Wrapped over edges fixed on reverse
- Suitable for pins and staples
- Ideal for portrait or landscape use
- Wall fixings included
- 7318L and 7324L are supplied in two parts
- 9 impressive colours to choose from
- 2 year product guarantee

Accents FlameShield Unframed Noticeboard	Code	Price
900(w) X 600mm(h)	7306L	£68.00
1200(w) X 900mm(h)	7309L	£101.00
1200(w) X 1200mm(h)	7312L	£120.00
1500(w) X 1200mm(h)	7315L	£156.00
1800(w) X 1200mm(h) (2 boards 1200 x 900mm)	7318L	£181.00
2400(w) X 1200mm(h) (2 boards 1200 x 1200mm)	7324L	£219.00

Colour Options



For fire regulation information, please see page 74.



Accents FlameShield Aluminium Framed Noticeboard

- Noticeboard core and bonded textile are fire retardant as a composite, meeting Class 0 when assessed to BS 476 Parts 6 and 7, and comply with Class B-s1, d0 when tested to BS-EN13501-1: 2002
- Satin silver anodised aluminium frame
- Rounded safety corners and concealed corner fixings
- Suitable for pins and staples
- Ideal for portrait or landscape use
- Wall fixings included
- 9 impressive colours to choose from
- 2 year product guarantee

Accents FlameShield Framed Noticeboard	Code	Price
900(w) X 600mm(h)	4806L	£74.00
1200(w) X 900mm(h)	4809L	£108.00
1200(w) X 1200mm(h)	4812L	£134.00
1500(w) X 1200mm(h)	4815L	£162.00
1800(w) X 1200mm(h)	4818L	£187.00
2400(w) X 1200mm(h)	4824L	£244.00

Side hinged

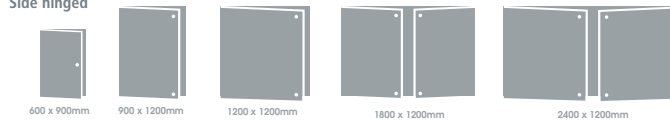

Top hinged

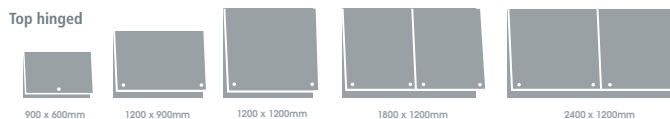

Accents FlameShield Tamperproof Noticeboard

- Noticeboard core and bonded textile are fire retardant as a composite, meeting Class 0 when assessed to BS 476 Parts 6 and 7, and comply with Class B-s1, d0 when tested to BS-EN13501-1: 2002
- The clear plastic doors are tested separately and conform to Class 1Y when assessed to BS 476 Part 7
- Top hinged models have stays to hold doors open (landscape use only)
- Satin silver anodised aluminium frame with rounded safety corners
- Single door models are suitable for portrait or landscape use
- Double door models are suitable for landscape use only
- Internal clearance is 20mm
- Suitable for pins/staples and wall fixings included
- 9 impressive colours to choose from
- 2 year product guarantee



Accents FlameShield Side Hinged	Code	Price
600(w) X 900mm(h)	5006L	£190.00
900(w) X 1200mm(h)	5009L	£266.00
1200(w) X 1200mm(h)	5012L	£329.00
1800(w) X 1200mm(h)	5018L	£499.00
2400(w) X 1200mm(h)	5024L	£588.00

Accents FlameShield Top Hinged	Code	Price
900(w) X 600mm(h)	5006TL	£219.00
1200(w) X 900mm(h)	5009TL	£292.00
1200(w) X 1200mm(h)	5012TL	£345.00
1800(w) X 1200mm(h)	5018TL	£525.00
2400(w) X 1200mm(h)	5024TL	£616.00



Impact

Accents noticeboards make an impressive impact in any education or office environment. Choose the style and colour that best meets your needs.

Fire Retardant Noticeboards



SmartShield FlameShield Aluminium Framed Noticeboard

- Noticeboard core and bonded textile are fire retardant as a composite, meeting Class 0 when assessed to BS 476 Parts 6 and 7, and comply with Class B-s1, d0 when tested to BS-EN13501-1: 2002
- Premium aluminium frame
- Contemporary and stylish in design
- Smooth rounded safety corners and concealed corner fixings
- Suitable for pins and staples
- Ideal for portrait or landscape use
- Wall fixings included
- Choice of 2 frame colours: aluminium or blue
- 4 board colours to choose from
- 2 year product guarantee

SmartShield Framed Noticeboard	Code	Price
900(w) X 600mm(h)	4751	£88.00
1200(w) X 900mm(h)	4752	£116.00
1200(w) X 1200mm(h)	4753	£134.00
1500(w) X 1200mm(h)	4754	£178.00
1800(w) X 1200mm(h)	4755	£194.00
2400(w) X 1200mm(h)	4756	£233.00

Colour Options (Board)

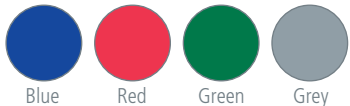

For fire regulation information, please see page 74.



Aluminium frame



Blue frame



SmartShield FlameShield Tamperproof Noticeboard

- Noticeboard core and bonded textile are fire retardant as a composite, meeting Class 0 when assessed to BS 476 Parts 6 and 7, and comply with Class B-s1, d0 when tested to BS-EN13501-1: 2002
- The clear plastic doors are tested separately and conform to Class 1Y when assessed to BS 476 Part 7
- Premium aluminium frame is contemporary and stylish in design
- Smooth rounded safety corners and concealed corner fixings
- Internal clearance is 20mm
- Suitable for pins and staples
- Single door models are suitable for portrait or landscape use
- Double door models are suitable for landscape use only
- Wall fixings included
- Choice of 2 frame colours: aluminium or blue
- 4 board colours to choose from
- 2 year product guarantee



Aluminium frame



Blue frame

SmartShield Tamperproof Noticeboard	Code	Price
600(w) X 900mm(h)	4761	£173.00
900(w) X 1200mm(h)	4762	£237.00
1200(w) X 1200mm(h)	4763	£297.00
1800(w) X 1200mm(h)	4765	£439.00
2400(w) X 1200mm(h)	4766	£536.00

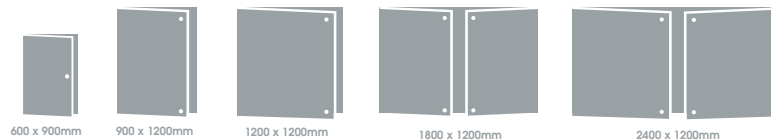



Premium

SmartShield noticeboards are contemporary and stylish in design with a smooth, premium frame finish. Perfect for displaying information in a modern and professional manner.

Fire Retardant Noticeboards



Premium Internal Showcase

- Superior quality internal showcase for displaying notices and information
- Noticeboard core and bonded textile are fire retardant as a composite, meeting Class 0 when assessed to BS 476 Parts 6 and 7, and comply with Class B-s1, d0 when tested to BS-EN13501-1: 2002
- The clear plastic doors are tested separately and conform to Class 1Y when assessed to BS 476 Part 7
- Choose from 7 colour options with aluminium frame or 4 colour options with powder coated frame
- Safe and secure double locking system
- Features gas strut assisted doors
- Internal clearance is 40mm
- Wall fixings included
- Made in the UK
- 2 year product guarantee

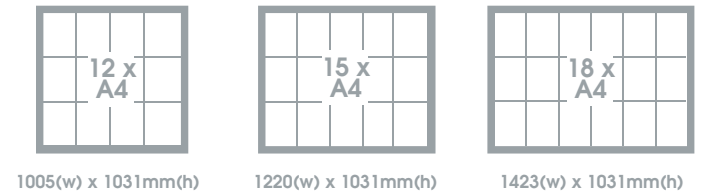
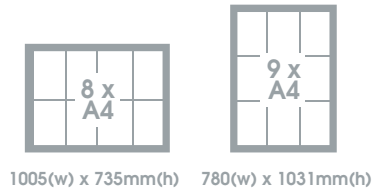

Premium Internal Showcase	Code	Price
1005(w) X 735mm(h) (8 x A4)	7110	£321.00
780(w) X 1031mm(h) (9 x A4)	7111	£344.00
1005(w) X 1031mm(h) (12 x A4)	7112	£387.00
1220(w) X 1031mm(h) (15 x A4)	7113	£432.00
1423(w) X 1031mm(h) (18 x A4)	7114	£460.00

Aluminium Frame Colour Options (Felt)



Powder Coated Frame Colour Options (Frame and Felt)



For fire regulation information, please see page 74.

Standards

Our Premium Internal Showcase is ideal for displaying information and notices in a professional manner. Designed to the highest standards for use in all areas including corridors.





Fire Retardant Noticeboards

The consequence of fire spread within circulation and escape routes presents a high risk to the building occupants. Materials and items on the walls of these areas should not propagate or accelerate a fire, therefore allowing the occupants the opportunity to exit safely. It is recommended that noticeboards used in these areas should be fire retardant.

FlameShield noticeboards are manufactured in the UK by Spaceright Europe Ltd.

The FlameShield noticeboard core and bonded textile are fire retardant as a composite, meeting Class 0 when assessed to BS 476 Parts 6 and 7 and comply with Class B-s1, d0 when tested to BS-EN13501-1: 2002.

The clear plastic doors used in tamperproof FlameShield noticeboards are tested separately, and conform to Class 1Y when assessed to BS 476 part 7.

FlameShield noticeboards are engineered to last and designed to meet the required standards, as a result you will find they are heavier, robust and more dense than a standard noticeboard.

Building owners may need to regularly review the fire risks in their premises to comply with their national regulations. Part of that review should consider the type and extent of noticeboard installed, the management of its use, the location of the noticeboard with respect to escape routes, and the other fire safety precautions within the building.

Documents related to fire safety risk assessments can be found at:
<https://www.gov.uk/government/collections/fire-safety-law-and-guidance-documents-for-business>



Noticeboards

Displaying internal notices and information to staff, pupils and visitors, requires an effective approach.

Our range of noticeboards offer versatility and style, with a variety of sizes, colour options and designs to choose from.

In addition to our large selection of textile noticeboards with aluminium or wooden frames, we also offer printed noticeboards in the form of our Pin Panelz range.

All of our noticeboards are:

- Manufactured to a high standard
- Supplied with wall fixings (where applicable)
- Available in a large selection of sizes, styles and colours

SPACERIGHT
europe ltd

spacerighteurope.com



Noticeboards



Unframed Noticeboard

- Felt fabric cover
- Wrapped over edges fixed on reverse
- Boards can be butted together to form large display surface
- Suitable for pins and staples
- Ideal for portrait or landscape use
- Wall fixings included
- 2218 and 2224 are supplied in two parts
- 4 colours to choose from
- 2 year product guarantee



Unframed Noticeboard	Code	Price
900(w) X 600mm(h)	2206	£41.00
1200(w) X 900mm(h)	2209	£56.00
1200(w) X 1200mm(h)	2212	£75.00
1500(w) X 1200mm(h)	2215	£84.00
1800(w) X 1200mm(h) (2 boards 1200 x 900mm)	2218	£94.00
2400(w) X 1200mm(h) (2 boards 1200 x 1200mm)	2224	£105.00

Aluminium Framed Noticeboard

- Satin silver anodised aluminium frame
- Felt fabric cover or cork
- Rounded safety corners and concealed corner fixings
- Suitable for pins and staples
- Ideal for portrait or landscape use
- Wall fixings included
- 5 colours to choose from
- 2 year product guarantee

Aluminium Framed Noticeboard	Code	Price
900(w) X 600mm(h)	7506	£40.00
1200(w) X 900mm(h)	7509	£55.00
1200(w) X 1200mm(h)	7512	£65.00
1500(w) X 1200mm(h)	7515	£81.00
1800(w) X 1200mm(h)	7518	£93.00
2400(w) X 1200mm(h)	7524	£115.00

Tamperproof Noticeboard

- PETG locking doors are virtually shatterproof
- Satin silver anodised aluminium frame
- Felt fabric cover or cork
- Rounded safety corners and concealed corner fixings
- Internal clearance is 20mm
- Top hinged models have stays to hold doors open (landscape use only)
- Single door models are suitable for portrait or landscape use
- Double door models are suitable for landscape use only
- Suitable for pins/staples and wall fixings included
- 5 colours to choose from
- 2 year product guarantee



Side Hinged Tamperproof Noticeboard	Code	Price
600(w) X 900mm(h)	7906	£100.00
900(w) X 1200mm(h)	7909	£142.00
1200(w) X 1200mm(h)	7912	£179.00
1800(w) X 1200mm(h)	7918	£273.00
2400(w) X 1200mm(h)	7924	£329.00

Top Hinged Tamperproof Noticeboard	Code	Price
900(w) X 600mm(h)	7906T	£125.00
1200(w) X 900mm(h)	7909T	£185.00
1200(w) X 1200mm(h)	7912T	£200.00
1800(w) X 1200mm(h)	7918T	£359.00
2400(w) X 1200mm(h)	7924T	£394.00

Colour Options



Cork only available on aluminium or tamperproof frame

Side hinged

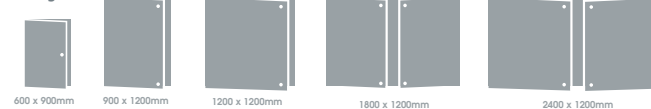

Top hinged

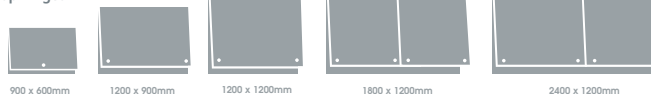



Mobile Noticeboard

- Double-sided mobile noticeboard
- Satin silver anodised aluminium frame
- Felt fabric cover
- Mobile stand features locking castors and stability bar
- Easy to position close to audience as required
- Height adjustable by 210mm
- Panels are freestanding and can be butted together
- Suitable for pins and staples
- Easy to assemble
- 4 colours to choose from
- 2 year product guarantee



Mobile Noticeboard	Code	Price
900(w) X 1200mm(h) Portrait	1654P	£162.00
1200(w) X 900mm(h) Landscape	1654L	£162.00
1200(w) X 1200mm(h)	1655	£197.00
1200(w) X 1500mm(h) Portrait	1657P	£224.00
1500(w) X 1200mm(h) Landscape	1657L	£224.00
1800(w) X 1200mm(h) Landscape	1659L	£236.00

Board Size (w x h)	Max Overall Size (w x h)	Min Overall Size (w x h)
900 x 1200 mm Portrait	940 x 1730 mm	940 x 1520 mm
1200 x 900 mm Landscape	1240 x 1580 mm	1240 x 1370 mm
1200 x 1200 mm Square	1240 x 1730 mm	1240 x 1520 mm
1200 x 1500 mm Portrait	1240 x 1880 mm	1240 x 1670 mm
1500 x 1200 mm Landscape	1540 x 1730 mm	1540 x 1520 mm
1800 x 1200 mm Landscape	1840 x 1730 mm	1840 x 1520 mm



Noticeboards



Accents Unframed Noticeboard

- Felt fabric cover
- Wrapped over edges fixed on reverse
- Boards can be butted together to form large display surface
- Suitable for pins and staples
- Ideal for portrait or landscape use
- Wall fixings included
- 8355 and 8356 are supplied in two parts
- 9 impressive colours to choose from
- 2 year product guarantee

Accents Unframed Noticeboard	Code	Price
900(w) X 600mm(h)	8351	£56.00
1200(w) X 900mm(h)	8352	£69.00
1200(w) X 1200mm(h)	8353	£79.00
1500(w) X 1200mm(h)	8354	£93.00
1800(w) X 1200mm(h) (2 boards 1200 x 900mm)	8355	£99.00
2400(w) X 1200mm(h) (2 boards 1200 x 1200mm)	8356	£124.00



Accents Aluminium Framed Noticeboard

- Satin silver anodised aluminium frame
- Felt fabric cover
- Rounded safety corners and concealed corner fixings
- Suitable for pins and staples
- Ideal for portrait or landscape use
- Wall fixings included
- 9 impressive colours to choose from
- 2 year product guarantee

Accents Aluminium Framed Noticeboard	Code	Price
900(w) X 600mm(h)	8306	£57.00
1200(w) X 900mm(h)	8309	£68.00
1200(w) X 1200mm(h)	8312	£84.00
1500(w) X 1200mm(h)	8315	£99.00
1800(w) X 1200mm(h)	8318	£108.00
2400(w) X 1200mm(h)	8324	£130.00

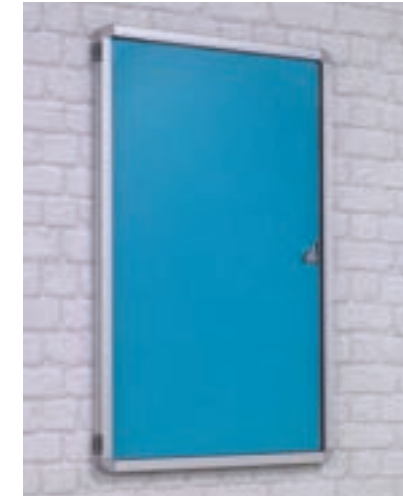

Accents Tamperproof Noticeboard

- PETG locking doors are virtually shatterproof
- Satin silver anodised aluminium frame
- Felt fabric cover
- Rounded safety corners and concealed corner fixings
- Top hinged models have stays to hold doors open (landscape use only)
- Single door models are suitable for portrait or landscape use
- Double door models are suitable for landscape use only
- Internal clearance is 20mm
- Suitable for pins/staples and wall fixings included
- 9 impressive colours to choose from
- 2 year product guarantee



Accents Side Hinged Tamperproof	Code	Price
600(w) X 900mm(h)	8406	£120.00
900(w) X 1200mm(h)	8409	£173.00
1200(w) X 1200mm(h)	8412	£197.00
1800(w) X 1200mm(h)	8418	£317.00
2400(w) X 1200mm(h)	8424	£362.00

Accents Top Hinged Tamperproof	Code	Price
900(w) X 600mm(h)	8406T	£138.00
1200(w) X 900mm(h)	8409T	£190.00
1200(w) X 1200mm(h)	8412T	£208.00
1800(w) X 1200mm(h)	8418T	£377.00
2400(w) X 1200mm(h)	8424T	£419.00

Colour Options

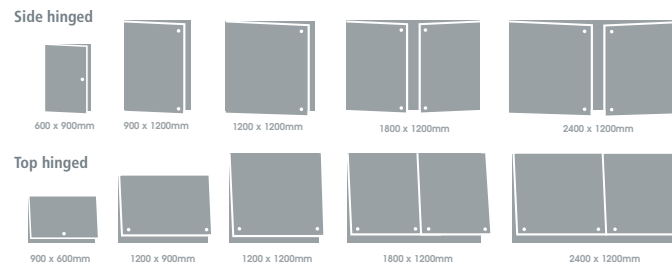
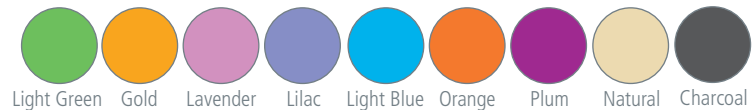



Accents Mobile Noticeboard

- Double-sided mobile noticeboard
- Satin silver anodised aluminium frame
- Felt fabric cover
- Mobile stand features locking castors and stability bar
- Easy to position close to audience as required
- Height adjustable by 210mm
- Panels are freestanding and can be butted together
- Suitable for pins and staples
- Easy to assemble
- 9 impressive colours to choose from
- 2 year product guarantee



Accents Mobile Noticeboard	Code	Price
900(w) X 1200mm(h) Portrait	8362P	£178.00
1200(w) X 900mm(h) Landscape	8362L	£178.00
1200(w) X 1200mm(h)	8363	£212.00
1200(w) X 1500mm(h) Portrait	8364P	£235.00
1500(w) X 1200mm(h) Landscape	8364L	£235.00
1800(w) X 1200mm(h) Landscape	8365L	£254.00

Board Size (w x h)	Max Overall Size (w x h)	Min Overall Size (w x h)
900 x 1200 mm Portrait	940 x 1730 mm	940 x 1520 mm
1200 x 900 mm Landscape	1240 x 1580 mm	1240 x 1370 mm
1200 x 1200 mm Square	1240 x 1730 mm	1240 x 1520 mm
1200 x 1500 mm Portrait	1240 x 1880 mm	1240 x 1670 mm
1500 x 1200 mm Landscape	1540 x 1730 mm	1540 x 1520 mm
1800 x 1200 mm Landscape	1840 x 1730 mm	1840 x 1520 mm





SmartShield Aluminium Framed Noticeboard

- Premium aluminium framed board
- Contemporary and stylish in design
- Felt fabric cover
- Smooth rounded safety corners and concealed corner fixings
- Suitable for pins and staples
- Ideal for portrait or landscape use
- Wall fixings included
- Choice of 2 frame colours: aluminium or blue
- 4 board colours to choose from
- 2 year product guarantee

SmartShield Framed Noticeboard	Code	Price
900(w) X 600mm(h)	4711	£73.00
1200(w) X 900mm(h)	4712	£100.00
1200(w) X 1200mm(h)	4713	£112.00
1500(w) X 1200mm(h)	4714	£135.00
1800(w) X 1200mm(h)	4715	£146.00
2400(w) X 1200mm(h)	4716	£176.00

Colour Options

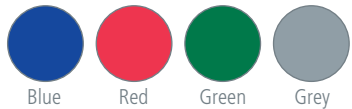

SmartShield Tamperproof Noticeboard

- Premium tamperproof board is contemporary and stylish in design
- PETG locking doors are virtually shatterproof
- Felt fabric cover
- Smooth rounded safety corners and concealed corner fixings
- Internal clearance is 20mm
- Single door models are suitable for portrait or landscape use
- Double door models are suitable for landscape use only
- Suitable for pins and staples
- Wall fixings included
- Choice of 2 frame colours: aluminium or blue
- 4 board colours to choose from
- 2 year product guarantee



SmartShield Tamperproof Noticeboard	Code	Price
600(w) X 900mm(h)	4721	£149.00
900(w) X 1200mm(h)	4722	£208.00
1200(w) X 1200mm(h)	4723	£224.00
1800(w) X 1200mm(h)	4725	£325.00
2400(w) X 1200mm(h)	4726	£402.00



Aluminium frame



Blue frame



Aluminium frame



Blue frame

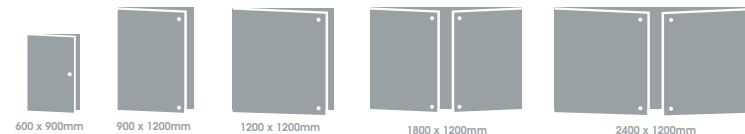



Refined

The smooth, rounded edge of SmartShield noticeboards achieves a stylish finish, and with the frame available in both blue and aluminium, a variety of prominent colour configurations are possible.

Noticeboards



SPACERIGHT
europe ltd



Rectangular (pack of 4)

Possible configurations with overall dimensions shown.

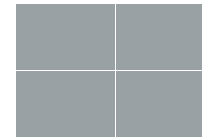

1800(w) x 1200mm(h)

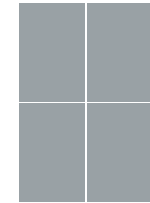

1200(w) x 1800mm(h)



3600(w) x 600mm(h)



2400(w) x 900mm(h)

EcoBoard

- Eco-friendly noticeboards made from 100% polyester fibre with a minimum 75% recycled material
- Safe, non-toxic and non-allergenic
- Lightweight with sound absorbing properties
- Suitable for pins and staples
- Ideal for educational and office environments
- Various configurations possible (as shown) or use individually in separate locations
- Wall fixings included (screws and fixing pads)
- 5 colours to choose from
- Available in pack of 4 (rectangular) or pack of 6 (hexagonal)
- Each pack contains one board colour

Hexagonal (Pack of 6)

	Code	Price
600(w) X 515mm(h)	2104/06	£168.00

Rectangular (Pack of 4)

	Code	Price
900(w) X 600mm(h)	2106/04	£172.00

Colour Options



Light Grey Dark Grey Orange Lilac Sky Blue

Hexagonal (pack of 6)

Possible configurations with overall dimensions shown.



1802(w) x 1050mm(h)



2100(w) x 1030mm(h)



1545(w) x 1500mm(h)



1545(w) x 1500mm(h)



1545(w) x 1500mm(h)



1545(w) x 1200mm(h)



1050(w) x 1802mm(h)



3000(w) x 772mm(h)



Eco-friendly

An eco-friendly display solution, with various configurations that deliver colour and style to the interior of any office, school, college or university.



Eco-friendly Tamperproof Noticeboard

- Environmentally friendly tamperproof noticeboard
- Light wood effect frame
- Felt fabric cover
- Virtually shatterproof plastic locking door
- Single door model
- Suitable for pins and staples
- Wall fixings included
- 4 colours to choose from
- 2 year product guarantee



Eco-friendly Noticeboard

- Environmentally friendly noticeboard
- Constructed from a high proportion of recycled material
- Felt fabric cover
- Light wood effect frame
- Suitable for pins and staples
- Ideal for portrait or landscape use
- Wall fixings included
- 4 board colours to choose from
- 2 year product guarantee



Eco-friendly Combination Board

- Environmentally friendly combination noticeboard
- Felt / non-magnetic dry-wipe noticeboard
- Constructed from a high proportion of recycled material
- Light wood effect frame
- Landscape orientation
- Wall fixings included
- 4 board colours to choose from
- 2 year product guarantee



Eco-friendly Tamperproof Noticeboard	Code	Price
600(w) X 900mm(h)	1865	£103.00
900(w) X 1200mm(h)	1866	£164.00

Eco-friendly Noticeboard	Code	Price
900(w) X 600mm(h)	1840	£51.00
1200(w) X 900mm(h)	1841	£62.00
1200(w) X 1200mm(h)	1842	£76.00
1500(w) X 1200mm(h)	1843	£89.00
1800(w) X 1200mm(h)	1844	£95.00
2400(w) X 1200mm(h)	1845	£119.00

Eco-friendly Combination Board	Code	Price
900(w) X 600mm(h)	1860	£78.00
1200(w) X 900mm(h)	1861	£90.00
1200(w) X 1200mm(h)	1859	£106.00
1500(w) X 1200mm(h)	1864	£145.00
1800(w) X 1200mm(h)	1862	£155.00
2400(w) X 1200mm(h)	1863	£174.00

Colour Options

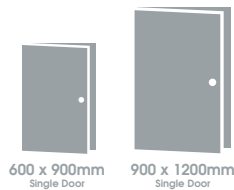
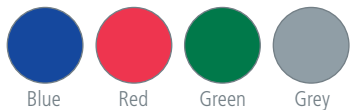



Sustainable

Environmentally friendly noticeboards constructed from a high proportion of recycled materials, featuring a light wood effect frame and felt fabric cover.

Noticeboards



SPACERIGHT
europe ltd



Pin Panelz Pantone Noticeboard

- Bold, colourful and stylish printed noticeboards
- Modern way to display information and notices
- Suitable for pins and Blu-Tack (pin holes are not self-sealing)
- Fully recyclable
- Chrome wall fixings included
- Choose from a large selection of pantone colours CMYK
- 1 year product guarantee



Pin Panelz Primary Noticeboard

- Bold, colourful printed noticeboards with wave border
- Perfect backdrop for displaying pupils' work
- Suitable for pins and Blu-Tack (pin holes are not self-sealing)
- Fully recyclable
- Chrome wall fixings included
- 9 colourful boards to choose from
- 1 year product guarantee



Pin Panelz Personalised Noticeboard

- Personalise your display with Pin Panelz
- Panels can be printed with your name, logo or crest
- Suitable for pins and Blu-Tack (pin holes are not self-sealing)
- Fully recyclable
- Chrome wall fixings included
- Choose from a large selection of pantone colours (CMYK)
- 1 year product guarantee



Pin Panelz Pantone Noticeboard	Code	Price
900(w) X 900mm(h)	PP09P****	£99.00
1200(w) X 1200mm(h)	PP12P****	£131.00

Pin Panelz Primary Noticeboard	Code	Price
900(w) X 900mm(h)	PP09PRIM***	£99.00
1200(w) X 1200mm(h)	PP12PRIM***	£131.00

Personalised Pin Panelz	Code	Price
900(w) X 900mm(h)	SPPP09****	£113.00
1200(w) X 1200mm(h)	SPPP12****	£146.00

When ordering please substitute **** with Pantone code below for relevant colour

Colour Options (Pantone)

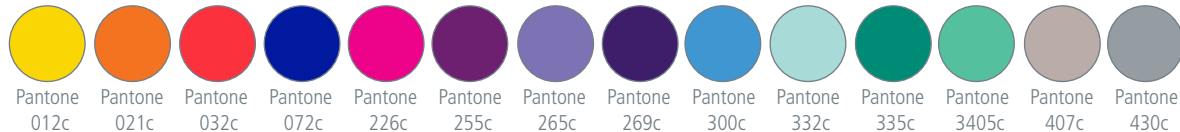

Other pantone CMYK colours are available upon request

Colour Options (Primary)



Pin Panelz is a unique concept in noticeboards. Vibrant, colourful and stylish, Pin Panelz provide a modern and fresh approach to displaying information in a way that will enhance your environment.

Unlike standard noticeboards, Pin Panelz are printed, which means the choice of colours is almost limitless. We have selected 14 of the most popular colours for the Pin Panelz Pantone range, however, other colours are available to match your corporate identity or school crest.



Personalisation

Pin Panelz can be personalised with your business/institution name, logo or crest, in a colour of your choice. Simply select the personalised Pin Panelz option, size and colour required, then place your order. We will then contact you to confirm the details and request any artwork you may have. A proof will be supplied prior to print and the lead time is 4 weeks from artwork approval. If you have any queries, please contact us on 0845 6017619.

Please note all personalised Pin Panelz are non-returnable.



Noticeboards



SPACERIGHT
europe ltd



Dual Pinup Pen Boards

- Combination felt / non-magnetic dry-wipe noticeboard
- Satin silver anodised aluminium frame
- Rounded safety corners and concealed corner fixings
- Wall fixings included
- 4 colours to choose from
- 2 year product guarantee

Dual Pinup Pen Boards	Code	Price
900(w) X 600mm(h)	0406	£74.00
1200(w) X 900mm(h)	0409	£88.00
1200(w) X 1200mm(h)	0412	£99.00
1500(w) X 1200mm(h)	0415	£132.00
1800(w) X 1200mm(h)	0418	£156.00
2400(w) X 1200mm(h)	0424	£182.00



Tamperproof Pinup Pen Boards

- Tamperproof combination felt / non-magnetic dry-wipe noticeboard
- Satin silver anodised aluminium frame
- PETG locking doors are virtually shatterproof
- Internal clearance is 20mm
- Rounded safety corners and concealed corner fixings
- Wall fixings included
- 4 colours to choose from
- 2 year product guarantee



Tamperproof Pinup Pen Boards	Code	Price
900(w) X 600mm(h)	0506	£163.00
1200(w) X 900mm(h)	0509	£218.00
1200(w) X 1200mm(h)	0512	£232.00
1800(w) X 1200mm(h)	0518	£303.00
2400(w) X 1200mm(h)	0524	£350.00



Mobile Pinup Pen Boards

- Double-sided combination mobile noticeboard
- Felt noticeboard / non-magnetic dry-wipe
- Satin silver anodised aluminium frame
- Mobile stand features locking castors and stability bar
- Easy to position close to audience as required
- Height adjustable by 210mm
- Panels are freestanding and can be butted together
- Suitable for pins and staples
- Easy to assemble
- 4 colours to choose from
- 2 year product guarantee

Board Size (w x h)	Overall Size (w x h)
1200 x 900 mm Landscape	Min: 1240 x 1370 mm Max: 1240 x 1580 mm
1200 x 1200 mm Square	Min: 1240 x 1520 mm Max: 1240 x 1730 mm
1500 x 1200 mm Landscape	Min: 1540 x 1520 mm Max: 1540 x 1730 mm
1800 x 1200 mm Landscape	Min: 1840 x 1520 mm Max: 1840 x 1730 mm



Mobile Pinup Pen Boards	Code	Price
1200(w) X 900mm(h)	1909	£173.00
1200(w) X 1200mm(h)	1912	£201.00
1500(w) X 1200mm(h)	1915	£207.00
1800(w) X 1200mm(h)	1918	£237.00

Colour Options

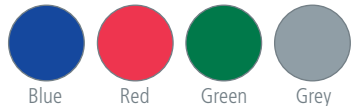

Writing Board Accessories



Size	Code	Price
Single	WBERAS1	£18.00
Pk12	WBERAS12	£46.00



Dry-wipe Pens

Size	Code	Price
Pk 4	DMPENSTASS4	£18.00



Board Cleaner

Size	Code	Price
250ml Spray	DWS.25	£20.00
1.0lt Bottle	DWC1	£22.00
2.5lt Bottle	DWC2.5	£40.00

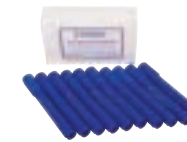

Dry-wipe Pens

Size	Code	Price
Pk10 Black	DMPENSTBK10	£29.00
Pk10 Blue	DMPENSTBU10	£29.00
Pk10 Red	DMPENSTRD10	£29.00
Pk10 Green	DMPENSTGN10	£29.00

Noticeboards



Mobile Flip Chart Noticeboard Combi

- Double-sided combination mobile noticeboard
- Felt noticeboard on one side and magnetic dry-wipe on reverse
- Satin silver anodised aluminium frame
- Mobile stand features locking castors and stability bar
- Easy to position close to audience as required
- Pen ledge and flip chart clamp on dry-wipe side
- Flip chart clamp (holds pads up to A1 size)
- Noticeboard suitable for pins and staples
- Panels are freestanding and can be butted together
- 4 colours to choose from
- 2 year product guarantee

Mobile Flip Chart Noticeboard Combi	Code	Price
1200(w) X 900mm(h)	1640	£200.00
1200(w) X 1200mm(h)	1641	£227.00
1800(w) X 1200mm(h)	1643	£272.00

Colour Options

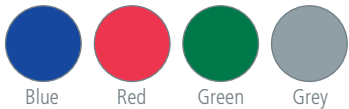

Blue

Red

Green

Grey





Sliding detail

Safety Sliding Door Noticeboard

- Locking noticeboard engineered for safety
- Sliding doors are virtually shatterproof
- White powder coated aluminium casing
- Tamperproof design for secure display
- Internal clearance is 20mm
- Suitable for pins and staples
- Wall fixings included
- 4 board colours to choose from
- 2 year product guarantee



Safety Sliding Door Noticeboard	Code	Price
1200(w) X 1200mm(h)	2712	£440.00
1800(w) X 1200mm(h)	2718	£517.00
2400(w) X 1200mm(h)	2725	£686.00

Colour Options



Blue Red Green Grey



Engineered

For secure display of information, the Sliding Noticeboard is the ultimate solution. Featuring an impressive aluminium frame, this noticeboard was engineered for safety and built to last.

Display & Exhibition

Our high-quality range of display and exhibition products delivers versatile solutions for presenting literature and creative ways to divide space.

Whether it is for parent evenings, corporate events or open days – our range allows you to showcase your information in a professional and effective manner.

Our comprehensive product range includes:

- Display screens
- Exhibition panels
- Trophy showcases
- Literature presentation

SPACERIGHT
europe ltd
spacerighteurope.com





Mobile Tri Screen

- Flexible, double-sided and mobile partitioning screen
- Ideal for exhibitions, dividing areas or displaying work
- Lightweight but sturdy structure
- Multiple configurations possible: straight line, bay, curved or right angle
- 3 panels with flexible gear hinges
- Each panel is 1800mm high
- Covered both sides with felt
- Suitable for pins
- Features locking castors and stability feet
- Folds flat for storage when not in use
- 4 colour options to choose from
- 2 year product guarantee

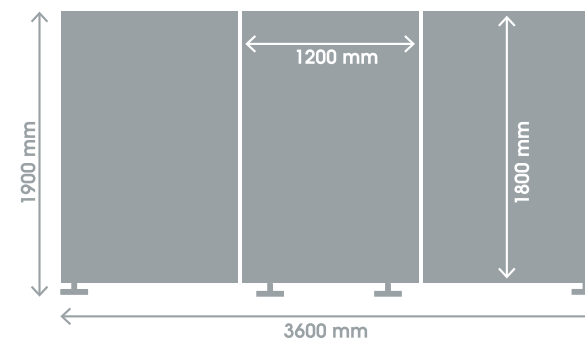

Mobile Tri Screen	Code	Price
3600(w) X 1900mm(h)	2618	£662.00

Colour Options



Blue

Red

Green

Grey



Hinge detail



Locking castors

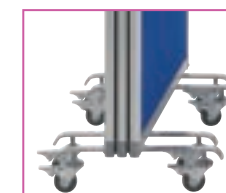

Folds flat for storage



Superior

Tri Screen is a superior exhibition and display product that is perfect for creating dedicated presentation areas or dividing space. Space efficient and sturdy in design.



Mobile Insta-Wall

- Sound absorbing mobile partitioning
- Ideal for temporary partitioning of large rooms, reception areas and halls
- Fits neatly into its own self contained frame
- Easily folds away when not in use
- Lightweight but sturdy structure is safely and easily operated by one person
- Full length piano hinges connect each panel
- Lockable castors fitted to each panel
- Design ensures the system is completely stable in any position including: straight line, bay, curve or right angle
- Individual panel size 600(w) x 1800mm(h)
- Available as 3, 5 or 7 panels
- 12 colour options to choose from
- 2 year product guarantee

Mobile Insta-Wall	Code	Price
1800(w) X 1940mm(h) (3 panel System)	2983	£828.00
3000(w) X 1940mm(h) (5 panel System)	2985	£1,012.00
4200(w) X 1940mm(h) (7 panel System)	2987	£1,294.00

Colour Options

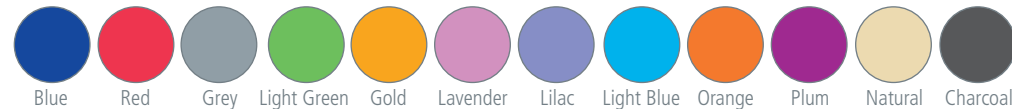

Folds away when not in use



Piano hinges connect each panel



Easily deployed by one person

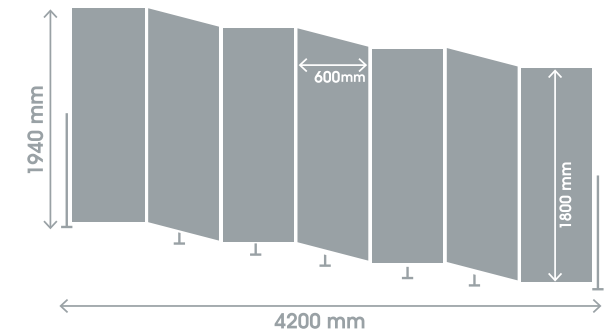
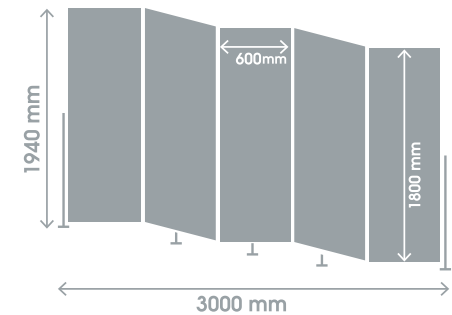
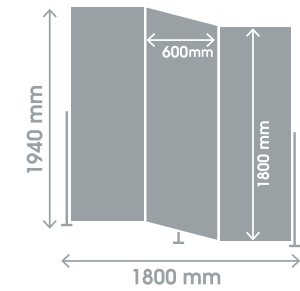

Watch the video



Scan the QR code



Perceptive

The perceptive design of Insta-Wall makes for a flexible and user-friendly product. Ideal for partitioning rooms or areas. Panels fold into the frame for efficient storage.

Display & Exhibition



SPACERIGHT
europe ltd



Xib-it Pole and Panel Noticeboard

- Pole and panel exhibition system
- Versatile design
- Double-sided fabric cover
- Single or multiple boards clip together to create your own unique system
- Large aluminium framed panel 1500(w) x 1200mm(h) can be mounted in landscape or portrait format at any height and angle
- Each panel is provided with two poles and bases for side by side use
- Flexible clip system allows the second panel to clip and join directly to the pole of the first panel
- Ultra heavy-duty metal bases for additional stability
- 12 colours to choose from
- 2 year product guarantee



Xib-it Pole and Panel Writing Board

- Pole and panel exhibition system
- Versatile design
- Double-sided magnetic writing board
- Single or multiple boards clip together to create your own unique system
- Large aluminium framed panel 1200(w) x 1500mm(h) can be mounted in landscape or portrait format at any height and angle
- Each panel is provided with two poles and bases for side by side use
- Flexible clip system allows the second panel to clip and join directly to the pole of the first panel
- Ultra heavy-duty metal bases for additional stability
- 2 year product guarantee



Possible configurations with Xib-it panels:

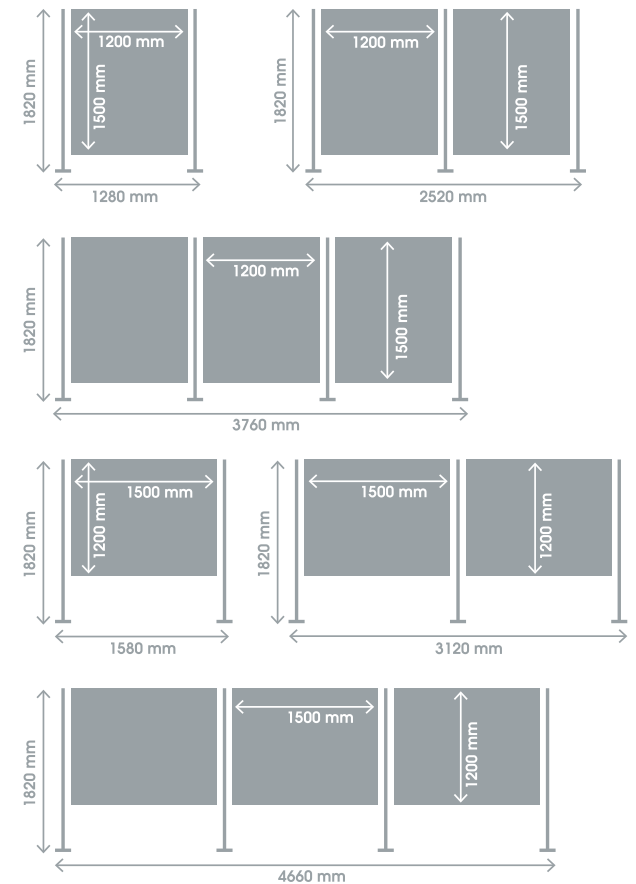

Xib-it Noticeboard

Code

Price

Noticeboard	5245	£285.00
-------------	------	---------

Xib-it Writing Board

Code

Price

Writing Board	5246	£351.00
---------------	------	---------

Colour Options

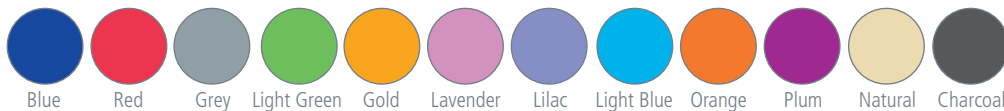

Pole clip

Pole clip insert

Pole clip twist



Exhibit

Xib-it Pole and Panel boards allow you to create impressive exhibition displays. With a sturdy structure and simple clip system, the panels are easy to use and reconfigure.



Multiple configurations possible using linking strip and foot plates



3 panel square



3 panel straight



3 panel curved

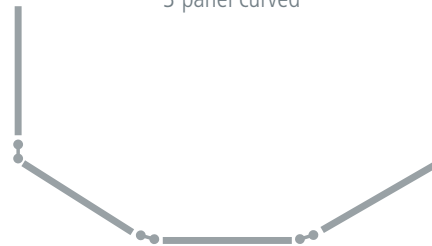

5 panel curved



Link strip



T foot plate

SpaceDividers

- High-quality, floor standing space dividers
- Ideal for dividing classrooms or separate study areas
- Multiple configurations possible
- Double-sided fabric cover
- Panels are acoustic and sound absorbing
- Screens are supplied as standard with linking strip, button feet and a set of 2 foot plates
- Variety of heights and widths available
- Stable and sturdy construction
- 30mm thick partitions
- 14 colours to choose from
- 1 year product guarantee

Standard Panel	Code	Price
900(w) X 1200mm(h)	8100	£208.00
1000(w) X 1200mm(h)	8101	£208.00
1200(w) X 1200mm(h)	8102	£216.00
1500(w) X 1200mm(h)	8103	£233.00
1600(w) X 1200mm(h)	8104	£235.00
1800(w) X 1200mm(h)	8105	£242.00
900(w) X 1500mm(h)	8106	£227.00
1000(w) X 1500mm(h)	8107	£227.00
1200(w) X 1500mm(h)	8108	£238.00
1500(w) X 1500mm(h)	8109	£249.00
1600(w) X 1500mm(h)	8110	£253.00
1800(w) X 1500mm(h)	8111	£263.00
900(w) X 1800mm(h)	8112	£241.00
1000(w) X 1800mm(h)	8113	£241.00
1200(w) X 1800mm(h)	8114	£252.00
1500(w) X 1800mm(h)	8115	£263.00
1600(w) X 1800mm(h)	8116	£266.00

Panel Accessories	Code	Price
Link Strip	8130	£31.00
T Foot Plate	8135	£25.00

Colour Options



Blue Red Maroon Grey Light Green Forest Gold Lavender Lilac Light Blue Orange Plum Natural Charcoal

Please note all SpaceDividers are made to order and non-returnable.



Enhance

Our SpaceDivider collection offers true versatility with a finish that will enhance any surrounding. An attractive colour palette compliments a variety of different environments.

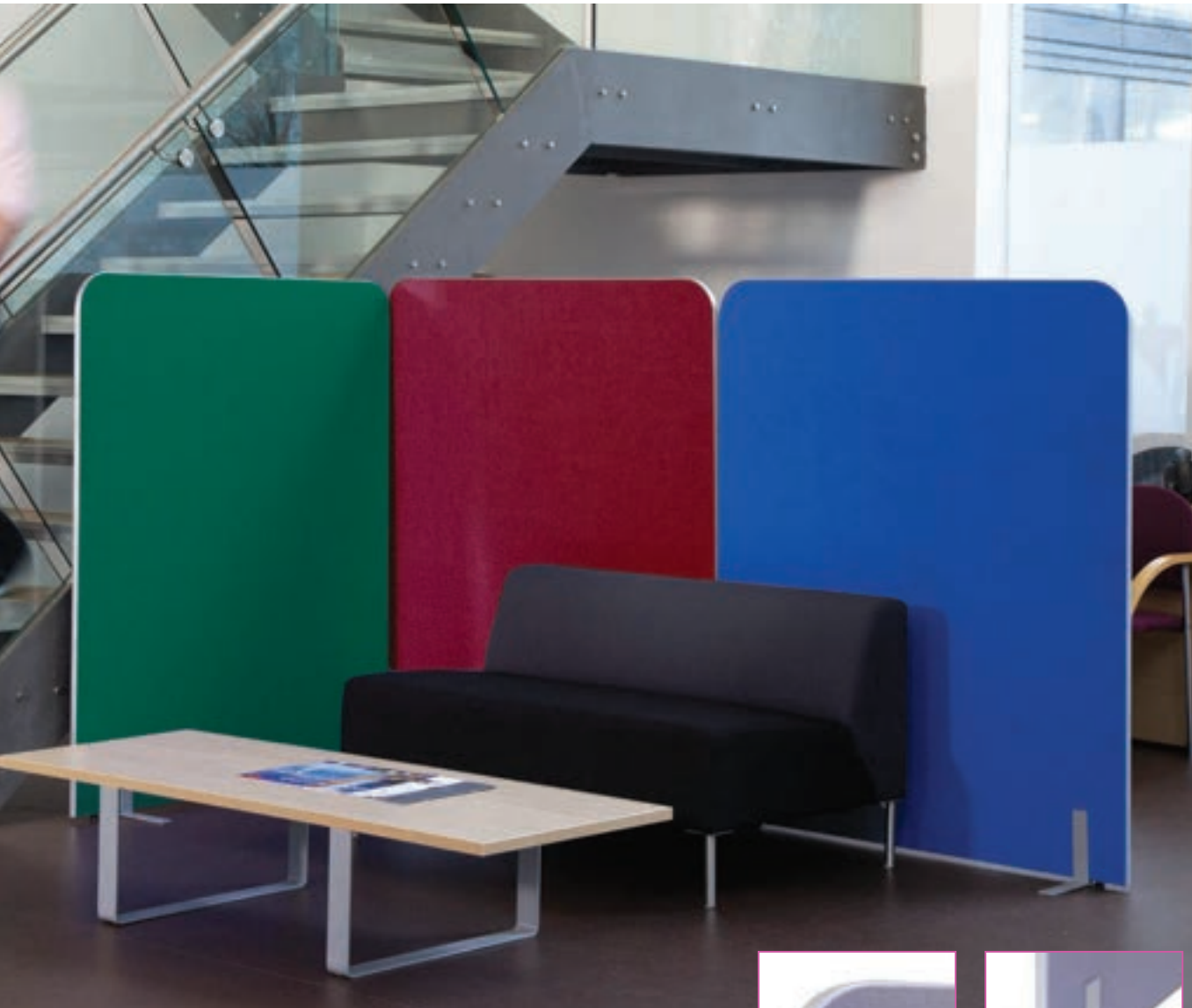

Curved SpaceDividers

- Sturdy, floor standing, curved space dividers
- Ideal for dividing classrooms, creating quiet or separate study areas
- Double-sided fabric cover
- Panels are acoustic and sound absorbing
- Screen are supplied as standard with button feet and a set of 2 foot plates
- Corner radius is 100mm
- Stable and sturdy construction
- 30mm thick partitions
- 7 colours to choose from
- 1 year product guarantee

Curved Panel	Code	Price
1000(w) X 900mm(h)	8120	£253.00
1000(w) X 1200mm(h)	8121	£273.00
1200(w) X 1200mm(h)	8122	£279.00
1500(w) X 1200mm(h)	8123	£297.00
1600(w) X 1200mm(h)	8124	£316.00
1800(w) X 1600mm(h)	8125	£348.00

Colour Options

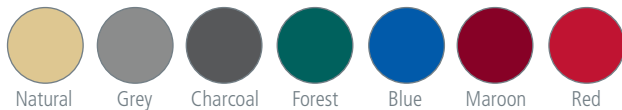

Natural Grey Charcoal Forest Blue Maroon Red



Curved edge



Foot plate

Display & Exhibition

Gallery Display Systems (40mm thick panels)

- Premium quality, robust display system that is versatile in design
- Use to permanently display work or create a semi-permanent project display
- Lightweight panels are portable, stable and suitable for heavy-duty use
- Simple to use and quick to assemble
- Panels lock together in seconds with the panel key provided
- Easy to reconfigure for maximum versatility
- Configuration allows for all blue or all grey
- Double-sided blue and grey fabric panels
- 1 year product guarantee

Panel Systems	Code	Price
2 Panel System 1800(w) X 1800mm(h)	5284	£450.00
3 Panel System 2700(w) X 1800mm(h)	5285	£668.00
4 Panel System 3600(w) X 1800mm(h)	5286	£885.00
6 Panel System 5400(w) X 1800mm(h)	5287	£1,325.00
Additional Panel 900(w) X 1800mm(h)	5283	£236.00

Dimensions shown are for straight-line configuration



2 panel system



3 panel system



4 panel system



6 panel system

Locking side



Grooved side



Key



Each panel has a plain grooved side and a locking side. Insert the locking side into the groove and lock in place.

Lock in place with key provided and repeat process for each panel.

Display & Exhibition



Lightweight Fold-Up Display Screen

- Fold-up display screen system with lightweight panels
- Double-sided panels are 600(w) x 900mm(h) and hinged together in two sections (except desktop version)
- Easy to fold up, store, transport and erect
- Supplied with heavy-duty zip-up nylon storage and carrying bag
- 3 colours to choose from
- 1 year product guarantee



Lightweight Fold-Up Landscape Desktop

Main panel size 900 x 600mm, hinged side panels 450 x 600mm, detachable header panel 900 x 250mm.

Code	Price
1800(w) X 850mm(h) (4 panel system)	5110 £176.00

Lightweight Fold-Up Portrait Desktop

Main panel size 600 x 900mm, hinged side panels 600 x 900mm, header panel 600 x 250mm.

Code	Price
1800(w) X 1150mm(h) (4 panel system)	5106 £235.00

Lightweight Fold-Up

Code	Price
1800(w) X 2050mm(h) (6 panel system)	5126 £335.00
1800(w) X 2050mm(h) (7 panel system with shelf)	5127 £385.00
2400(w) X 2050mm(h) (8 panel system)	5128 £407.00

Colour Options

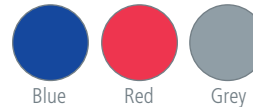

8 panel shown

Display & Exhibition

Heavy-duty Fold-up Display Screen

- Fold-up display screen system with heavy-duty panels
- Double-sided panels are 600(w) x 900mm(h) and hinged together in two sections (except desktop version)
- Easy to fold up, store, transport and erect
- Supplied with heavy-duty zip-up nylon storage and carrying bag
- 3 colours to choose from
- 1 year product guarantee



Heavy-duty Fold-up Landscape Desktop

Main panel size 900 x 600mm, hinged side panels 450 x 600mm, detachable header panel 900 x 250mm.

	Code	Price
1800(w) X 850mm(h) (4 panel system)	5134	£118.00

Heavy-duty Fold-up Portrait Desktop

Main panel size 600 x 900mm, hinged side panels 600 x 900mm, header panel 600 x 250mm.

	Code	Price
1800(w) X 1150mm(h) (4 panel system)	5135	£156.00

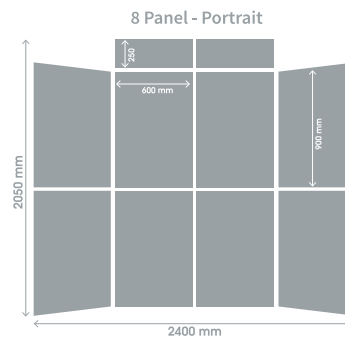
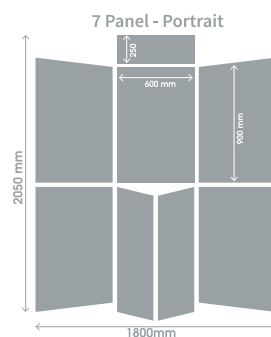
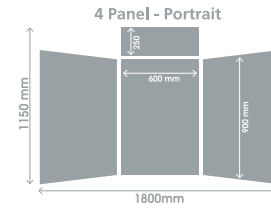
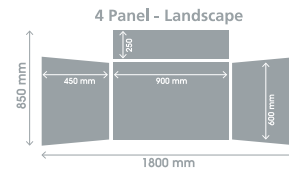

Diagram applies to both heavy and lightweight systems



SPACERIGHT
europe ltd



Heavy-duty Fold-Up

	Code	Price
1800(w) X 2050mm(h) (6 panel system)	5136	£277.00
1800(w) X 2050mm(h) (7 panel system with shelf)	5137	£305.00
2400(w) X 2050mm(h) (8 panel system)	5138	£340.00

6 panel shown

Colour Options

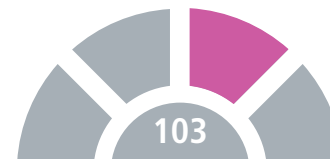
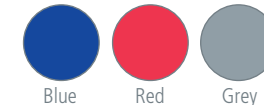



Crystal Wall Staff / Class Board

- Professional way to present names and pictures of staff and/or pupils
- Simply print required pictures and slot into the easy-fill pockets
- 6mm virtually shatterproof PETG board
- Pocket size 60(w) x 82mm(h)
- Pockets are self-closing and reusable
- Chrome stand-off fixings supplied
- Depth including wall fixings is 30mm
- Optional nameplate board available (Code: CWNPB)
- 1 year product guarantee

9 pockets	Code	Price
320(w) X 386mm(h)	CWSB01	£166.00

20 pockets	Code	Price
415(w) X 620mm(h)	CWSB02	£210.00

35 pockets	Code	Price
720(w) X 620mm(h)	CWSB03	£276.00



Crystal Wall Staff / Class Board (6 pockets)

- Professional way to present staff and/or class pupils
- Simply print required pictures and slot into the pockets
- 6mm virtually shatterproof PETG board
- Pockets are self-closing and reusable
- Chrome stand-off fixings supplied
- Depth including wall fixings is 30mm
- Optional nameplate board available (Code: CWNPB)
- 1 year product guarantee

6 pockets (Small)	Code	Price
180(w) X 320mm(h)	CWPB02	£119.00

6 pockets (Large)	Code	Price
250(w) X 450mm(h)	CWPB01	£139.00



Crystal Wall Team Board

- 20 pocket display board
- Professional way to present team names and pictures
- Simply print required pictures and slot into the pockets
- 6mm virtually shatterproof PETG board
- Pocket size 90(w) x 132mm(h)
- Pockets are self-closing and reusable
- Chrome stand-off fixings supplied
- Depth including wall fixings is 30mm
- Optional nameplate board available (Code: CWNPB)
- 1 year product guarantee

Crystal Wall Team Board	Code	Price
539(w) X 870mm(h)	CWTB01	£253.00



Easy-fill pockets

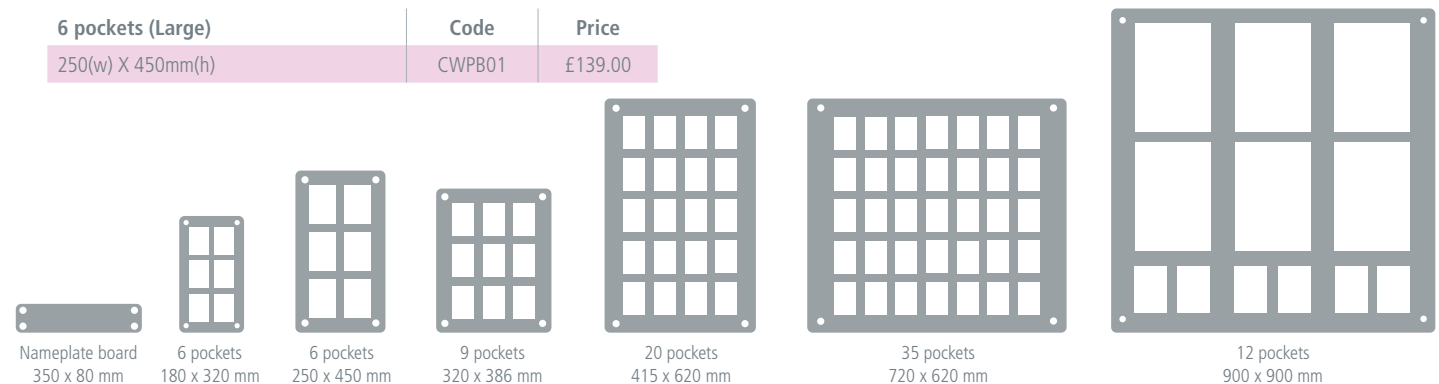



Crystal Wall Notice Frame (12 pockets)

- Modern and professional way to display signs and notices
- 6mm virtually shatterproof PETG board
- Pocket sizes 6 x A4 and 6 x 90(w) x 130mm(h)
- Pockets are self-closing and reuseable
- Chrome stand-off fixings supplied
- Depth including wall fixings is 30mm
- 1 year product guarantee

Crystal Wall Notice Frame	Code	Price
900(w) X 900mm(h)	CWPB04	£300.00



Crystal Wall Nameplate

- Designed to accompany Crystal Wall Staff/Class and Team boards
- Features 2 plates of 3mm virtually shatterproof PETG
- Name slides between plates and is then fixed to wall
- Chrome 30mm stand-off fixings supplied
- 1 year product guarantee

Crystal Wall Nameplate	Code	Price
350(w) X 80mm(h)	CWNPB	£34.00



Informative

Crystal Wall display boards are a professional and modern way to present information to visitors. The picture pockets are easy to use and information can be changed as required.



Crystal Wall Notice Frame

- Modern and professional way to display signs and notices
- Designed for A5 and A4 signs
- Features 2 plates of 3mm virtually shatterproof PETG
- Sign/notice slides between plates and is then fixed to wall
- Chrome stand-off fixings supplied
- Depth including wall fixings is 30mm
- 1 year product guarantee

Crystal Wall Notice Frame	Code	Price
A5 - 210(w) X 272mm(h)	CWNPBA5	£53.00
A4 - 272(w) X 359mm(h)	CWNPBA4	£64.00



Easy-fill pockets



Personalisation pocket



Crystal Wall School Achievements Board (Landscape)

- An impressive way to display news and achievements
- Simply print required notices and slot into the pockets
- 8mm virtually shatterproof PETG board
- Pockets quantities/sizes: 7 x A4, 5 x A5 and 3 x 132(h) x 90mm(w)
- Includes personalisation pocket for name
- Pockets are self-closing and reusable
- Chrome stand-off fixings supplied
- Depth including wall fixings is 30mm
- 1 year product guarantee

School Achievements Board Landscape	Code	Price
1200(w) X 900mm(h)	CWDB01	£384.00

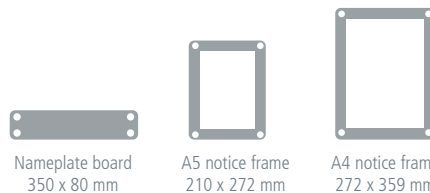

Crystal Wall School Achievements Board (Portrait)

- An impressive way to display news and achievements
- Simply print required notices and slot into the pockets
- 8mm virtually shatterproof PETG board
- Pockets quantities/sizes: 6 x A4, 6 x A5 and 6 x 132(h) x 90mm(w)
- Includes personalisation pocket for name
- Pockets are self-closing and reusable
- Chrome stand-off fixings supplied
- Depth including wall fixings is 30mm
- 1 year product guarantee

School Achievements Board Portrait	Code	Price
900(w) X 1200mm(h)	CWDB02	£384.00

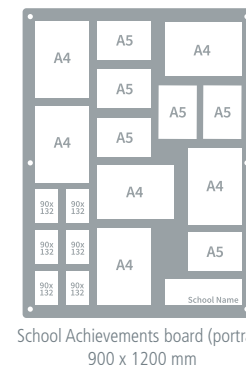

School Achievements board (portrait)
900 x 1200 mm

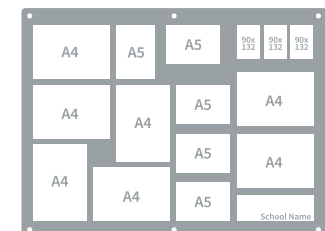

School Achievements board (landscape)
1200 x 900 mm

Modern

Display achievements with pride using these modern and professional boards. Crystal Wall comes complete with chrome fixings and reusable pockets.



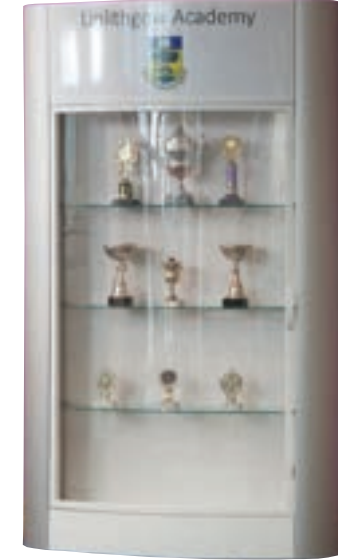

Wall Mounted Trophy Showcase

- Wall mounted cabinet for displaying trophies and awards
- Features white centre panel with anodised aluminium sides
- Ideal for mounting at eye level for effective display
- No floor space required - ideal for smaller areas
- Secure and locking PETG door
- 2 glass display shelves (210mm(d) fixed at 350mm intervals)
- Strong and durable construction
- Heavy-duty wall fixings included
- LED light version available with 3 downlights
- 10 year product guarantee

Wall Mounted Trophy Showcase 1200(w) X 1000(h) X 250mm(d)	Code	Price
Without lights	4697	£1,119.00
With LED lights	4697/1	£1,356.00

Floor Standing Trophy Showcase

- Prestigious and fitting showpiece to display trophies and awards
- High-quality, sturdy and freestanding construction
- Showcase features a white centre panel with anodised aluminium sides
- Ideal for reception areas
- Secure and locking PETG door
- 3 glass display shelves (210mm(d) fixed at 350mm intervals)
- LED light option available with 3 uplights and 3 downlights
- Footprint 1200(w) X 250mm(d)
- 10 year product guarantee

Floor Standing Trophy Showcase 1200(w) X 2000(h) X 250mm(d)	Code	Price
Without lights	4696	£1,560.00
With LED lights	4696/1	£1,788.00

Personalised Floor Standing Trophy Showcase

- Prestigious and fitting showpiece to display trophies and awards
- High-quality, sturdy, freestanding construction
- Showcase features a white centre panel with anodised aluminium sides
- Centre panel is personalised to feature name and/or logo
- Ideal for reception areas
- Secure and locking PETG door
- 3 glass display shelves (210mm(d) fixed at 350mm intervals)
- LED light option available with 3 uplights and 3 downlights
- Footprint 1200(w) X 250mm(d)
- 10 year product guarantee

Floor Standing Personalised Trophy Showcase 1200(w) X 2000(h) X 250mm(d)	Code	Price
With graphic, without lights	4698	£1,802.00
With graphic and LED lights	4698/1	£2,033.00



Showcase internal detail

Personalisation

The showcase is personalised with your business / institution name, logo or crest. Simply place your order and we will contact you to confirm the details and request any artwork you may have. A proof will be supplied prior to print, and the lead time is 4 weeks from artwork approval. If you have any queries, please contact us on 0845 6017619.

Please note all personalised Trophy Showcases are non-returnable.

Prestigious

The Trophy Showcase from Spaceright is a prestigious and fitting showpiece to display your trophies and awards. It's curved, contemporary design and soft lines will enhance any reception or welcome area.



Display & Exhibition



SPACERIGHT
europe ltd



Poster Display Frame

- Spring loaded mitred poster case
- Snap open and close aluminium frame
- Wall fixings included
- Protective UV film
- Recommended for indoor use
- 5 colour options to choose from
- 1 year product guarantee

Aluminium Poster Display Frame	Code	Price
A4 - 250(w) X 335mm(h)	4198	£22.00
A3 - 310(w) X 435mm(h)	4197	£24.00
A2 - 460(w) X 630mm(h)	4196	£34.00
Poster - 545(w) X 800mm(h)	4192	£42.00
A1 - 635(w) X 885mm(h)	4195	£42.00
Poster - 700(w) X 1000mm(h)	4193	£54.00
A0 - 885(w) X 1225mm(h)	4194	£72.00

Colour Poster Display Frame	Code	Price
A4 - 250(w) X 335mm(h)	4264	£33.00
A3 - 310(w) X 435mm(h)	4263	£40.00
A2 - 460(w) X 630mm(h)	4262	£48.00
A1 - 635(w) X 885mm(h)	4261	£60.00
A0 - 885(w) X 1225mm(h)	4260	£88.00

Colour Options (Poster Display Frame)



Secure Poster Display Frame

- Spring loaded mitred secure poster case
- Snap open and close frame
- Once frame is closed, tool is required to open
- Opening tool supplied
- Protective UV film
- Recommended for indoor use
- Anodised aluminium
- Wall fixings included
- 1 year product guarantee

Secure Poster Display Frame	Code	Price
A4 - 250(w) X 335mm(h)	4284	£43.00
A3 - 310(w) X 435mm(h)	4283	£48.00
A2 - 460(w) X 630mm(h)	4282	£49.00
A1 - 635(w) X 885mm(h)	4281	£82.00
A0 - 885(w) X 1225mm(h)	4285	£124.00



Opening tool



Tamperproof Poster Display Frame

- Spring loaded mitred tamperproof poster case
- Snap open and close frame
- Frame is locked using allen bolt
- Once frame is closed Allen key is required to open
- Protective UV film
- Recommended for indoor use
- Anodised aluminium
- Wall fixings included
- 1 year product guarantee



Tamperproof Poster Display Frame	Code	Price
A4 - 250(w) X 335mm(h)	4289	£49.00
A3 - 310(w) X 435mm(h)	4293	£54.00
A2 - 460(w) X 630mm(h)	4292	£75.00
A1 - 635(w) X 885mm(h)	4291	£102.00
A0 - 885(w) X 1225mm(h)	4290	£131.00
Poster 20" X 30" - 500(w) X 700mm(h)	4287	£79.00
Poster 30" X 40" - 700(w) X 1000mm(h)	4288	£93.00



Unlocked



Locked



Poster Display A Frame

- Heavy-duty aluminium structure
- Suitable for outdoor or indoor use
- Snap open and close aluminium or black frame
- Front opening 32mm profile
- Galvanised steel backing
- Chrome rounded corners
- Hinge flat for storage and portability
- Easy assembly
- 1 year product guarantee



Chrome corners

Poster Display A Frame (Silver)	Code	Price
A2 - 400(w) X 574mm(h)	4021	£119.00
A2 - Chalkboard Insert	CHKINSERTA2	£19.00
A1 - 574(w) X 821mm(h)	4022	£126.00
A1 - Chalkboard Insert	CHKINSERTA1	£38.00
A0 - 821(w) X 1169mm(h)	4023	£172.00
Poster 30" X 40" - 700(w) X 1000mm(h)	4020	£192.00

Poster Display A Frame (Black)	Code	Price
A1 - 574(w) X 821mm(h)	4016	£126.00
A1 - Chalkboard Insert	CHKINSERTA1	£38.00
A0 - 821(w) X 1169mm(h)	4017	£172.00
Poster 30" X 40" - 700(w) X 1000mm(h)	4018	£193.00





Crystal Clear Wall Mounted Leaflet Dispenser

- Versatile and contemporary wall mounted leaflet dispenser
- High-quality construction with various configurations
- Design maximises leaflet exposure and provides full height support
- High gloss and virtually shatterproof PETG frame
- Wall fixings included
- 2 colour options to choose from
- 2 year product guarantee

Wall Mounted Leaflet Dispensers

	Code	Price
8 x A4 - 462(w) X 750(h) X 175mm(d)	4530	£298.00
16 x A4 - 914(w) X 750(h) X 175mm(d)	4531	£393.00
12 x A5 - 487(w) X 630(h) X 175mm(d)	4532	£331.00
16 x 1/3A4 - 462(w) X 600(h) X 175mm(d)	4533	£298.00
6 x A5 - 487(w) X 350(h) X 110mm(d)	4534	£187.00
12 x 1/3A4 - 688(w) X 350(h) X 110mm(d)	4535	£204.00
6 x A4 and 6 x 1/3A4 - 688(w) X 750(h) X 110mm(d)	4536	£314.00
6 x A4 - 688(w) X 450(h) X 110mm(d)	4537	£224.00

Colour Options

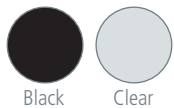

4530 - 8 x A4

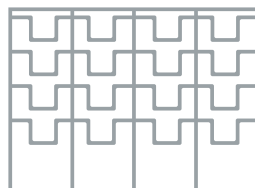

4531 - 16 x A4

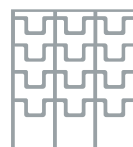

4532 - 12 x A5

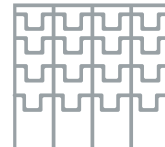

4533 - 16 x 1/3 A4



4534 - 6 x A5



4535 - 12 x 1/3 A4

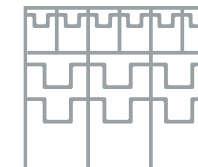

4536 - 6 x A4 & 6 x 1/3 A4

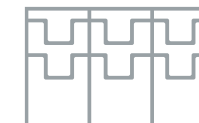

4537 - 6 x A4

Classroom Furniture & Storage

A collection of products designed to enhance nursery and classroom environments.

Storage is an essential requirement in any nursery or classroom. The Millhouse storage range from Spaceright is designed and manufactured in the UK with flexibility, durability and safety in mind.

In addition, we have a vast selection of easels that encourage collaboration. Children can write or draw their ideas on the board, then present their work to the rest of the class.

Many of our easels are height adjustable to accommodate children of different ages.

SPACERIGHT
europe ltd
spacerighteurope.com





Tray Storage Unit (1 column)

- 1 column tray storage unit suitable for shallow and deep trays
- Premium MDF core with clear lacquered edges
- Lockable castors are anti-scratch and low-noise
- Units are designed with flexible runners to house different depths of trays
- Velcro display surface on reverse
- Tray colour is clear as standard
- Fully assembled
- 10 year product guarantee

Tray Storage Unit (1 column) 360(w) X 730(h) X 465mm(d)	Code	Price
3 deep clear trays	PT697	£247.00
2 shallow, 2 deep clear trays	PT698	£249.00
6 shallow clear trays	PT683	£254.00



Tray Storage Unit (2 column)

- 2 column tray storage unit suitable for shallow and deep trays
- Premium MDF core with clear lacquered edges
- Lockable castors are anti-scratch and low-noise
- Units are designed with flexible runners to house different depths of trays
- Velcro display surface on reverse
- Tray colour is clear as standard
- Fully assembled
- 10 year product guarantee

Tray Storage Unit (2 column) 700(w) X 730(h) X 465mm(d)	Code	Price
6 deep clear trays	PT692	£330.00
4 shallow, 4 deep clear trays	PT693	£331.00
12 shallow clear trays	PT684	£343.00



Tray Storage Unit (3 column)

- 3 column tray storage unit suitable for shallow and deep trays
- Premium MDF core with clear lacquered edges
- Lockable castors are anti-scratch and low-noise
- Units are designed with flexible runners to house different depths of trays
- Velcro display surface on reverse
- Tray colour is clear as standard
- Fully assembled
- 10 year product guarantee

Tray Storage Unit (3 column) 1045(w) X 730(h) X 465mm(d)	Code	Price
9 deep clear trays	PT647	£423.00
6 shallow, 6 deep clear trays	PT650	£428.00
18 shallow clear trays	PT644	£447.00

Tray Storage Unit (3 column) 1045(w) X 900(h) X 465mm(d)	Code	Price
12 deep clear trays	PT648	£473.00
6 shallow, 9 deep clear trays	PT651	£480.00
24 shallow clear trays	PT645	£500.00

Tray Storage Unit (3 column) 1045(w) X 1080(h) X 465mm(d)	Code	Price
15 deep clear trays	PT649	£530.00
6 shallow, 12 deep clear trays	PT652	£543.00
30 shallow clear trays	PT646	£564.00



Velcro display back on all tray storage units



Reconfigure

The flexible runners on our tray storage units maximise storage and allow easy reconfiguration. The loop nylon on the reverse is ideal for displaying work.



Discovery Shelf Storage (2 Column)

- Storage unit with space for 4 jumbo size trays
- Premium hard-wearing maple melamine with clear lacquered edges
- Lockable castors are anti-scratch and low-noise
- Velcro display surface on reverse
- No built in runners, trays simply sit on shelf
- Available with or without trays
- Tray colour is clear as standard
- Fully assembled
- 10 year product guarantee

Discovery Shelf Storage (2 Column) 700(w) X 900(h) X 465mm(d)	Code	Price
Without trays	PT685	£301.00
With trays	PT694	£373.00



Clear trays



Velcro display back



Discovery Shelf Storage (4 Column)

- Storage unit with space for 8 jumbo size trays
- Premium hard-wearing, maple melamine with clear lacquered edges
- Lockable castors are anti-scratch and low-noise
- Velcro display surface on reverse
- No built in runners, trays simply sit on shelf
- Available with or without trays
- Tray colour is clear as standard
- Fully assembled
- 10 year product guarantee

Discovery Shelf Storage (4 Column) 1386(w) X 900(h) X 465mm(d)	Code	Price
Without trays	PT686	£434.00
With trays	PT696	£518.00





Store

Versatile shelf storage solutions for nursery and classroom environments. Flexible in design, the units can be used in all areas of learning.



Display surface on back with free removable mirror

Lockable Tall Storage Cupboard

- Perfect for storing classroom resources or office files/books
- 2 door lockable storage cupboard
- Made from maple melamine
- 6 shelves (4 height adjustable)
- Fully assembled
- 10 year product guarantee

Lockable Storage Cupboard

- Perfect for storing classroom resources or office files/books
- 2 door lockable storage cupboard
- Made from maple melamine
- 3 shelves (2 height adjustable)
- Fully assembled
- 10 year product guarantee

Lockable Storage Cupboard with Display and Mirror Back

- 2 door lockable storage cupboard
- 3 shelves (2 height adjustable)
- Velcro display surface on back with free removable mirror
- Made from maple melamine
- Fully assembled
- Top shelf: 800mm(h)
- 10 year product guarantee

Lockable Tall Storage Cupboard	Code	Price
1000(w) X 1800(h) X 495mm(d)	PT689	£669.00

Lockable Storage Cupboard	Code	Price
1000(w) X 1000(h) X 495mm(d)	PT888	£525.00

Lockable Storage Cupboard	Code	Price
900(w) X 900(h) X 400mm(d)	PT889	£478.00

Robust

Perfect for classroom use, these durable and heavy-duty cupboards are of sturdy construction and delivered fully assembled.





Storage box

Little Acorns Store 'N' Write Mobile Easel

- Mobile easel with solid wood frame
- Single-sided magnetic writing board
- Display board size 600(w) x 900mm(h)
- Features heavy-duty locking wheels
- Available with or without storage tray
- Full length pen ledge
- Foot print: 630(w) x 530mm(d)
- 10 year product guarantee



Store 'N' Write Easel	Code	Price
630(w) X 1400(h) X 530mm(d)	3303	£301.00

Store 'N' Write Easel with Storage	Code	Price
630(w) X 1400(h) X 530mm(d)	3302	£348.00



Paper roll



Paint pots

Little Acorns Play 'N' Learn Mobile Easel

- Double-sided mobile easel with solid wood frame
- Magnetic dry-wipe surface with a chalkboard on the reverse
- Display board size 600(w) x 900mm(h)
- Features heavy-duty locking wheels for ease of movement
- Includes large storage tray and paper roll holder
- Sturdy and stable construction
- Foot print: 630(w) x 600mm(d)
- 10 year product guarantee



Play 'N' Learn	Code	Price
630(w) X 1520(h) X 600mm(d)	3301	£462.00

	Code	Price
Paper Roll	3320	£21.00
Paint Pots	3321	£14.00



Little Acorns Share 'N' Write Desktop Easel

- Desktop easel with solid wood frame
- Suitable for use on the floor or on a desktop
- Double-sided design folds away for easy storage
- Display board size 600(w) x 450mm(h)
- Magnetic dry-wipe surface with a chalkboard on the reverse
- Features heavy-duty steel carry handle and stay on side
- Handy ledge on both sides for displaying a book or holding pens
- 10 year product guarantee

Share 'N' Write	Code	Price
White/Chalk 600(w) X 552(h) X 433mm(d)	3307	£179.00



Learn

Little Acorns products are beautifully made from solid wood. These premium products are designed with helpful features such as book ledges and storage trays.



Little Rainbows Store 'N' Write Big Book Board

- Big book board with sturdy steel frame and storage
- Magnetic or non-magnetic dry-wipe writing surface
- Ergonomically designed with a 15 degree writing angle
- Display board size 600(w) x 900mm(h)
- Easy to transport with 2 locking castors
- Full length big book display ledge
- Foot Print: 600(w) x 450mm(d)
- 2 colours to choose from
- 5 year surface guarantee

Non-magnetic Big Book Board	Code	Price
600(w) X 1340(h) X 450mm(d)	1699	£218.00

Magnetic Big Book Board	Code	Price
600(w) X 1340(h) X 450mm(d)	1677	£221.00



Little Rainbows Mobile Magnetic Display Easel

- Mobile adjustable easel with coloured steel frame
- Choose from single-sided or double-sided
- Display board size 600(w) x 900mm(h)
- Ergonomically designed with a 12.5 degree writing angle
- Integral flip chart clamp and big book display ledge
- Foot Print: 652(w) x 642mm(d) (single) / 652(w) x 664mm(d) (double)
- Magnetic dry-wipe surface
- Features 4 locking castors for safety
- 2 colours to choose from
- 5 year surface guarantee

Mobile Magnetic Display Easel	Code	Price
Single Sided 652(w) X 1450(h) X 642mm(d)	1679	£163.00
Double-sided 652(w) X 1450(h) X 664mm(d)	1685	£242.00



Little Rainbows Mobile Magnetic Display/Storage Easel

- Mobile adjustable easel with coloured steel frame
- Choose from single-sided or double-sided
- Display board size 900(w) x 900mm(h)
- Ergonomically designed with a 12.5 degree writing angle
- Foot Print: 952(w) x 642mm(d) (single) / 952(w) x 664mm(d) (double)
- Supplied with 2 storage trays (red trays with blue frame, blue trays with red frame)
- Magnetic dry-wipe surface
- Features 4 locking castors for safety
- Integral flip chart clamp and big book display ledge
- 5 year surface guarantee



Mobile Magnetic Display/Storage Easel	Code	Price
Single Sided 952(w) X 1450(h) X 642mm(d)	1678	£201.00
Double-sided 952(w) X 1450(h) X 664mm(d)	1684	£296.00

Colour Options

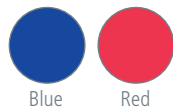

Big Book ledge



Big Book storage



Flip chart clamp



Storage trays



Participate

Mobile easels are a great classroom resource, not only do they encourage children to be expressive and participate but they can also be used for group activities. Features a book ledge and storage tray.

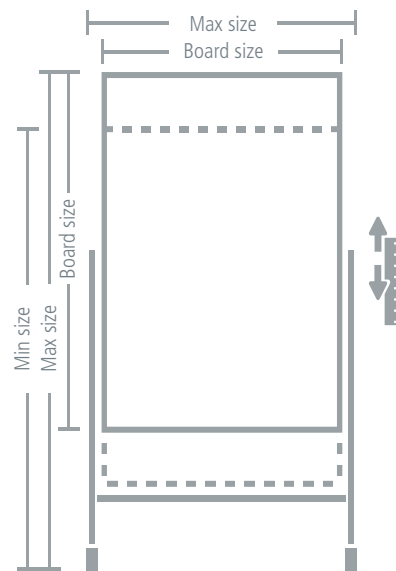

Board Size (w x h)	Max Overall Size (w x h)	Min Overall Size (w x h)
600 x 900 mm Portrait	640 x 1580 mm	640 x 1370 mm
900 x 600 mm Landscape	940 x 1420 mm	940 x 1210 mm
900 x 1200 mm Portrait	940 x 1730 mm	940 x 1520 mm
1200 x 900 mm Landscape	1240 x 1580 mm	1240 x 1370 mm
1200 x 1500 mm Portrait	1240 x 1880 mm	1240 x 1670 mm
1500 x 1200 mm Landscape	1540 x 1730 mm	1540 x 1520 mm

Little Rainbows Junior Mobile Board

- Freestanding mobile writing board
- Double-sided with the choice of magnetic or non-magnetic surface
- Features 4 castors (2 locking) and stability bar
- Harlequin board frame with contrasting rounded safety corners
- Board can be height adjustable by 210mm
- Overall stand foot depth 540mm
- Blue steel frame
- 5 year surface guarantee



Non-magnetic Junior Mobile Board	Code	Price
600(w) X 900mm(h) Portrait	1670P	£155.00
900(w) X 600mm(h) Landscape	1670L	£155.00
900(w) X 1200mm(h) Portrait	1680P	£167.00
1200(w) X 900mm(h) Landscape	1680L	£167.00
1200(w) X 1500mm(h) Portrait	1690P	£201.00
1500(w) X 1200mm(h) Landscape	1690L	£201.00

Magnetic Junior Mobile Board	Code	Price
600(w) X 900mm(h) Portrait	1673P	£191.00
900(w) X 600mm(h) Landscape	1673L	£191.00
900(w) X 1200mm(h) Portrait	1683P	£205.00
1200(w) X 900mm(h) Landscape	1683L	£205.00
1200(w) X 1500mm(h) Portrait	1693P	£270.00
1500(w) X 1200mm(h) Landscape	1693L	£270.00



Little Rainbows Mobile Tilt 'N' Teach

- Rotating double-sided writing board
- Choice of magnetic or non-magnetic surface
- Display board size 900(w) x 600mm(h)
- Lockable in any position
- Features 4 lockable castors and stability bar
- Full length ledge for displaying big books
- 2 colours to choose from
- Aluminium frame
- Foot print: 1000(w) x 500mm(d)
- 5 year surface guarantee



Non-magnetic Mobile Tilt 'N' Teach	Code	Price
1000(w) X 1300(h) X 500mm(d) Grey	1675	£168.00
1000(w) X 1300(h) X 500mm(d) Red	1675/3	£168.00

Magnetic Mobile Tilt 'N' Teach	Code	Price
1000(w) X 1300(h) X 500mm(d) Grey	1676	£188.00
1000(w) X 1300(h) X 500mm(d) Red	1676/3	£188.00

Colour Options





Rotating

Junior mobile writing boards are a handy class resource. The Mobile Tilt 'n' Teach has a rotating, double sided writing board that can lock in any position.



Flip chart clamp



Little Rainbows Read 'N' Write Board

- Aluminium framed board with easy carry handle
- Suitable for use on the floor or on a desktop
- Choice of magnetic or non-magnetic surface
- Display board size 900(w) x 600mm(h)
- Features heavy-duty carry handle and stay on side
- Full length big book ledge
- Folds flat for storage
- 5 year surface guarantee

Little Rainbows Desktop Easel

- Aluminium framed desktop easel with rounded safety corners
- Suitable for use on the floor or on a desktop
- Choice of magnetic (aluminium frame) or non-magnetic (harlequin frame) surface
- Display board size 600(w) x 500mm(h)
- Anti-slip safety catch on side
- Integrated flip chart clamp
- Folds flat for storage
- 5 year surface guarantee

Little Rainbows Twin Desktop Easel

- Double-sided, aluminium framed desktop easel
- Choice of magnetic or non-magnetic surface
- Suitable for use on the floor or on a desktop
- Display board size 600(w) x 450mm(h)
- Harlequin in colour with rounded safety corners
- Anti-slip safety catch on side
- Plastic bumpers prevent accidental slipping
- Folds flat for storage
- 5 year surface guarantee

Non-magnetic Read 'N' Write Board	Code	Price
900(w) X 600mm(h)	3536	£117.00

Magnetic Read 'N' Write Board	Code	Price
900(w) X 600mm(h)	3537	£129.00

Non-magnetic Desktop Easel	Code	Price
600(w) X 500mm(h) (Harlequin frame)	3502	£105.00

Magnetic Desktop Easel	Code	Price
600(w) X 500mm(h) (Aluminium frame)	3509	£117.00

Non-magnetic Desktop Easel	Code	Price
600(w) X 450mm(h)	3515	£112.00

Magnetic Desktop Easel	Code	Price
600(w) X 450mm(h)	3518	£152.00

Writing Board Accessories



Junior Dry-wipe Pens

Size	Code	Price
Pack of 10 Black	CLASSPACK PEN	£29.00



Mini Dusters

Size	Code	Price
Pk 30	MINIDUSTER30	£23.00



Dry-wipe Pens

Size	Code	Price
Pk 4	DMPENSTASS4	£18.00



Board Cleaner

Size	Code	Price
250ml Spray	DWS.25	£20.00
1.0lt Bottle	DWC1	£22.00
2.5lt Bottle	DWC2.5	£40.00

Practical

Although designed with desktop use in mind, these easels can also be used on the floor, depending on the activity or task. All easels fold for practical storage.



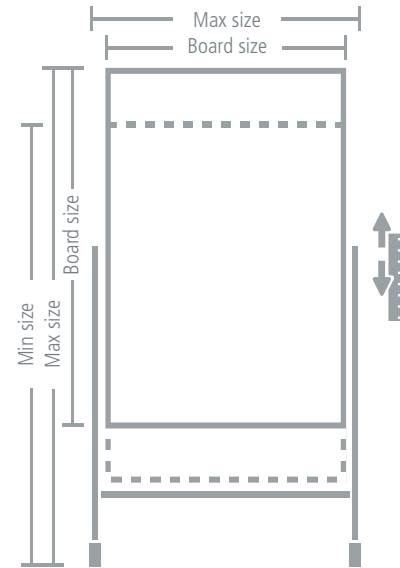
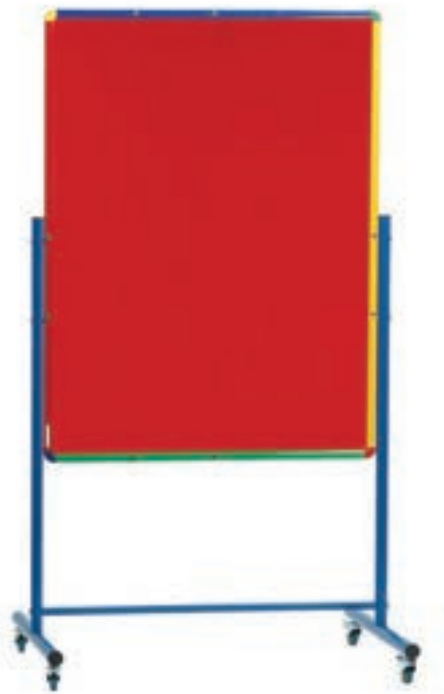

Little Rainbows Junior Mobile Partition

- Double-sided, harlequin style aluminium framed partition
- Mobile blue steel frame with 4 locking castors
- Choice of landscape or portrait panels
- Height adjustable by 210mm
- Felt finish on both sides
- Suitable for pins
- 4 colour options to choose from
- 2 year product guarantee



Junior Mobile Partitions

	Code	Price
900(w) X 1200mm(h) Portrait	2902P	£160.00
1200(w) X 900mm(h) Landscape	2902L	£160.00
1200(w) X 1500mm(h) Portrait	2905P	£207.00
1500(w) X 1200mm(h) Landscape	2905L	£207.00

Colour Options

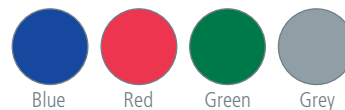

Little Rainbows Freestanding Junior Partition

- Double-sided harlequin style aluminium framed partition
- Steel stabiliser feet
- Panels may be used landscape or portrait
- Partitions can be nested when not in use for efficient storage
- Felt finish on both sides
- Suitable for pins
- 4 colour options to choose from
- 2 year product guarantee

Freestanding Junior Partitions

	Code	Price
1200(w) X 900mm(h)	2901	£131.00
1500(w) X 1200mm(h)	2904	£188.00

Classroom Furniture & Storage



SPACERIGHT
europe ltd



Little Acorns Wooden Frame Junior Partition

- Double-sided solid wood display partition
- Steamed beech wood frame and foot plate from sustainable sources
- Supplied with glides and castors for static or mobile use
- Felt finish on both sides
- Suitable for pins
- 5 colour options to choose from
- 10 year product guarantee

Wooden Frame Junior Partitions	Code	Price
1200(w) X 900mm(h)	4449	£348.00
900(w) X 1200mm(h)	4450	£348.00
1200(w) X 1200mm(h)	4451	£417.00
1500(w) X 1200mm(h)	4452	£462.00

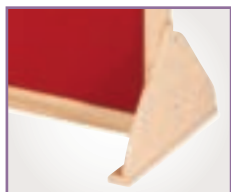

Glides only



Glides and castors



Frame Size (w x h)	Height with Glides	Height with Castors
1200 x 900 mm Landscape	920 mm	980 mm
900 x 1200 mm Portrait	1220 mm	1280 mm
1200 x 1200 mm	1220 mm	1280 mm
1500 x 1200 mm Landscape	1220 mm	1280 mm

Colour Options



Blue

Red

Green

Grey

Natural

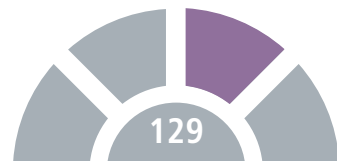

Our Services



Site Survey (Free of charge service)

To help with the buying process, we would be delighted to arrange a free site survey. A member of our dedicated and experienced team will visit you to discuss your requirements and take the necessary measurements. This information will then be shared with our product design team who will provide bespoke space plans.

3D Space Planning (Free of charge service)

One of the most important services we provide to our customers is delivering detailed, aesthetic designs of cafeteria/dining room layouts. Our product design team are experts in creating bespoke dining solutions and space plans. These designs are produced using 3D CAD (computer aided design) to give a detailed idea of how the environment will look and feel.



Free Gold Service Delivery

All orders for dining furniture (except Fast Fold) are delivered by our Free Gold Service Delivery. Our team will deliver your tables on a day that is convenient for you using sustainable packaging. We will unpack and commission the tables, then our expert team will provide training on using and caring for your tables.



Transported using sustainable packaging



Delivery on a day that is convenient for you



Tables unpacked and commissioned on site



Expert training on caring for your tables



Space plan for 12 x 12 Seat Rectangular Tables

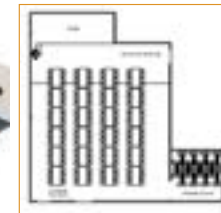

Space plan for 14 x 12 Seat Rectangular and 12 x 8 Seat Round Tables



Space plan for 14 x 8 Seat Round Tables

For further information on all our services, please call 0845 6017619 or email sales@spacerighteurope.com

Item Code	Page	Item Code	Page	Item Code	Page	Item Code	Page	Item Code	Page	Item Code	Page	Item Code	Page	Item Code	Page
0106	30	1611P	36	3227	48	4755	70	7324L	68	8351L	78	9SR101230PRO3S	26	GW15	46
0109	30	1613L	36	3228	49	4756	70	7401	58	8352L	78	9SR101625	18	GW18	46
0112	30	1613P	36	3229	49	4761	36	7402	58	8353L	78	CHKINSERTA1	111	GW45	46
0115	30	1615	36	3301	120	4762	70	7403	58	8354L	78	CHKINSERTA2	111	GW60	46
0118	30	1617L	36	3302	120	4763	70	7404	58	8355L	78	CHLKOA100	44	GW65	46
0124	30	1617P	36	3303	120	4765	70	7406	60	8356L	78	CHLKOW100	44	GW90	46
0131G50	40	1619L	36	3307	120	4766	70	7408	60	8362L	79	CLASSPACKPEN	126	GWP12	46
0131L75	40	1640	89	3320	120	4806H	66	7411	58	8362P	79	COND.25	30	GWP15	46
0131M	40	1641	89	3321	120	4806L	66	7412	58	8363	79	COND1	30	GWP18	46
0132G50	40	1643	89	3500	52	4809H	66	7413	58	8364L	79	COND2.5	30	GWP45	46
0132L75	40	1654L	77	3502	126	4809L	66	7414	58	8364P	79	CWDB01	106	GWP60	46
0132M	40	1654P	77	3509	126	4812H	66	7416	60	8365L	79	CWDB02	106	GWP65	46
0133G50	40	1655	77	3515	126	4812L	66	7432	62	8406L	78	CWNPB	105	GWP90	46
0133L75	40	1657L	77	3518	126	4815H	66	7433	62	8406TL	78	CWNPBA4	106	MINIDUSTER30	30, 126
0133M	40	1657P	77	3536	126	4815L	66	7434	62	8409L	78	CWNPBAS	106	PP09P****	86
0134G50	40	1659L	77	3537	126	4818H	66	7435	62	8409TL	78	CWPB01	104	PP12P****	86
0134L75	40	1670L	124	4016	111	4818L	66	7436	62	8412L	78	CWPB02	104	PP09PRIM****	86
0134M	40	1670P	124	4017	111	4824H	66	7442	62	8412TL	78	CWPB04	105	PP12PRIM****	86
0136G50	40	1673L	124	4018	111	4824L	66	7443	62	8418L	78	CWSB01	104	PT644	114
0136L75	40	1673P	124	4020	111	5006H	66	7444	62	8418TL	78	CWSB02	104	PT645	114
0136M	40	1675	124	4021	111	5006L	66	7445	62	8424L	78	CWSB03	104	PT646	114
0138G50	40	1675/3	124	4022	111	5006TH	66	7446	62	8424TL	78	CWTB01	104	PT647	114
0138L75	40	1676	124	4023	111	5006TL	66	7450	60	9012	50	DMPENSTASS4	30, 44, 53, 56, 88, 126	PT648	114
0138M	40	1676/3	124	4192	110	5009H	66	7451	60	9016	50	DMPENSTBK10	30, 43, 88	PT649	114
0406	88	1677	122	4193	110	5009L	66	7452	60	9019	50	DMPENSTBU10	30, 43, 88	PT650	114
0409	88	1678	122	4194	110	5009TH	66	7453	60	9025	50	DMPENSTGN10	30, 43, 88	PT651	114
0412	88	1679	122	4195	110	5009TL	66	7454	60	9112	50	DMPENSTRD10	30, 43, 88	PT652	114
0415	88	1680L	124	4196	110	5012H	66	7455	60	9116	50	DWC1	43, 90, 88, 126	PT683	114
0418	88	1680P	124	4197	110	5012L	66	7460	60	9119	50	DWC2.5	43, 90, 88, 126	PT684	114
0424	88	1683L	124	4198	110	5012TH	66	7461	60	9125	50	DWS.25	43, 90, 88, 126	PT685	116
0506	88	1683P	124	4260	110	5012TL	66	7462	60	95001	54	FFB4H0	8	PT686	116
0509	88	1684	122	4261	110	5018H	66	7463	60	95001BL	55	FFB4H1	8	PT689	118
0512	88	1685	122	4262	110	5018L	66	7464	60	95001BLK	55	FFB4H2	8	PT692	114
0518	88	1690L	124	4263	110	5018TH	66	7465	60	95001GRN	55	FFB4H3	8	PT693	114
0524	88	1690P	124	4264	110	5018TL	66	7472	62	95001GRY	55	FFB5H0	8	PT694	116
0806	30	1693L	124	4281	110	5024H	66	7473	62	95001R	55	FFB5H1	8	PT696	116
0809	30	1693P	124	4282	110	5024L	66	7474	62	95001WH	55	FFB5H2	8	PT697	114
0812	30	1699	122	4283	110	5024TH	66	7475	62	95003	54	FFB5H3	8	PT698	114
0815	30	1840	84	4284	110	5024TL	66	7476	62	95006	56	FFB6H0	8	PT888	118
0818	30	1841	84	4285	110	5106	102	7480	60	95007	56	FFB6H1	8	PT889	118
0824	30	1842	84	4287	110	5110	102	7481	60	95008	56	FFB6H2	8	SEC3220P	48
1006	44	1843	84	4288	110	5126	102	7482	60	95009GRN	56	FFB6H3	8	SEC3220WD	48
1009	44	1844	84	4289	110	5127	102	7483	60	95009GRY	56	FFBUN1L4H1W1	10	SEC322075L	48
1012	44	1845	84	4290	110	5128	102	7484	60	95009WH	56	FFBUN1L4H1W2	10	SEC322050S	48
1015	44	1850	44	4291	103	7485	62	95010	53	95010	56	FFBUN1L4H2W1	10	SEC3221P	48
1018	44	1851	44	4292	103	7506	76	95014	56	95014	56	FFBUN1L4H2W2	10	SEC3221WD	48
1024	44	1852	44	4293	103	7509	76	95015	56	95015	56	FFBUN1L4H3W1	10	SEC322175L	48
1031	44	1853	44	4449	129	5137	103	7512	76	95016	52	FFBUN1L4H3W2	10	SEC322150S	48
1032	44	1854	44	4450	129	5138	103	7515	76	95111	54	FFBUN1L6H1W1	10	SEC3222P	48
1033	44	1855	44	4451	129	5245	96	7518	76	95151	32	FFBUN1L6H1W2	10	SEC3222WD	48
1034	44	1859	84	4452	129	5246	96	7524	76	95152	32	FFBUN1L6H2W1	10	SEC322275L	48
1035	44	1860	84	4520	112	5283	101	7906	76	95153	32	FFBUN1L6H2W2	10	SEC322250S	48
1036	44	1861	84	4531	112	5284	101	7906T	76	95157	32	FFBUN1L6H3W1	10	SEC3223P	48
1112	32	1862	84	4532	112	5285	101	7909	76	95158	32	FFBUN1L6H3W2	10	SEC3223WD	48
1115	32	1863	84	4533	112	5286	101	7909T	76	95159	32	FFBUN2L4H1W1	10	SEC322375L	48
1118	32	1864	84	4534	112	5287	101	7912	76	95200/40	33	FFBUN2L4H1W2	10	SEC322350S	48
1124	32	1865	84	4535	112	6120	42	7912T	76	95333	54	FFBUN2L4H2W1	10	SEC3224P	48
1220	38	1866	84	4536	112	6121	42	7918	76	95600	41	FFBUN2L4H2W2	10	SEC3224WD	48
1221	38	1909	88	4537	112	6122	42	7918T	76	95601	41	FFBUN2L4H3W1	10	SEC322475L	48
1222	38	1912	88	4696	88	42	7924	62	95602	41	FFBUN2L4H3W2	10	SEC322450S	48	
1223	38	1915	88	4696/1	88	6242	82	7924T	76	95CB	6	FFBUN2L6H1W1	10	SEC3225P	48
1224	38	1918	88	4697	88	7110	72	8100	98	95CS	6	FFBUN2L6H1W2	10	SEC3225WD	48
1260	38	2104/06	82	4697/1	88	7111	72	8101	98	95CT	6	FFBUN2L6H2W1	10	SEC322575L	48
1261	38	2106/04	82	4698	88	7112	72	8102	98	95LBU1027	22	FFBUN2L6H2W2	10	SEC322550S	48
1262	38	2206	76	4698/1	88	7113	72	8103	98	95LBU1029	22	FFBUN2L6H3W1	10	SEC3226P	48
1263	38	2209	76	4711	80	7114	72	8104	98	95LCB827	20	FFBUN2L6H3W2	10	SEC3226WD	48
1264	38	2212	76	4712	80	7201	58	8105	98	95LCB829	20	FFR4HOW1	8	SEC322675L	48
1275	38	2215	76	4713	80	7202	58	8106	98	95RLG0827	12	FFR4HOW2	8	SEC322650S	48
1276	38	2218	76	4714	80	7203	58	8107	98	95RLG0829	12	FFR4H1W1	8	SEC3227P	48
1277	38	2224	76	4715	80	7204	58	8108	98	95RLOCT60827	12	FFR4H1W2	8	SEC3227WD	48
1278	38	2618	92	4716	80	7205	58	8109	98	95RLOCT60829	12	FFR4H2W1	8	SEC322775L	48
1279	38	2712	80	4721	80	7206	58	8110	98	95RLG0830PRO1	24	FFR4H2W2	8	SEC322750S	48
1280	38	2718	80	4722	80	7207	58	8111	98	95RLG0830PRO1FB	24	FFR4H3W1	8	SEC3228P	49
1281	38	2725	80	4723	80	7221	64	8112	98	95RLG0830PRO1S	24	FFR4H3W2	8	SEC3228WD	49
1282	38	2790	80	4725	80	7222	64	8113	98	95RLG0830PRO2	24	FFR5HOW1	8	SEC322875L	49
1283	38	2791	80	4726	80	7223	64	8114	98	95RLG0830PRO2FB	24	FFR5HOW2	8	SEC322850S	49
1284	38	2901	128	4731	34	7224	64	8115	98	95RLG0830PRO2S	24	FFR5H1W1	8	SEC3229P	49
1306	32	2902L	128	4732	34	7225	64	8116	98	95RLG0830PRO3	24	FFR5H1W2	8	SEC3229WD	49
1309	32	2902P	128	4733	34	7226	64	8120	100	95RLG0830PRO3FB	24	FFR5H2W1	8	SEC322975L	49
1312	32	2904	128	4734	34	7227	64	8121	100	95RLG0830PRO3S	24	FFR5H2W2	8	SEC322950S	49
1315	32	2905L	128	4735	34	7306H	66	8122	100	95RL80827	14	FFR5H3W1	8	SPPP09P****	86
1318	32	2905P	128	4736	34	7306L	66	8123	100	95RL80829	14	FFR5H3W2	8	SPPP12P****	86
1324	32	2983	94	4741	34	7309H	66	8124	100	95RL101227	16	FFR6HOW1	8	WBERAS1	30, 53, 88
1601L	36	2985	94	4742	34	7309L	66	8125	100	95RL101229	16	FFR6HOW2	8	WBERAS12	30, 53, 88
1601P	36	2987	94	4743	34	7312H	66	8130	98	95RL101230PRO1	26	FFR6H1W1	8	XLD	30, 44
1603L	36	3220	48	4744											



Spaceright Europe Ltd
38 Tollpark Road, Wardpark East,
Cumbernauld, G68 0LW
01236 853120
sales@spacerighteurope.com

spacerighteurope.com

