

R2140

800 x 470 x 2140mm Bookcase

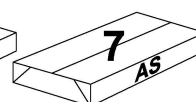

**TOOLS REQUIRED
FOR ASSEMBLY**

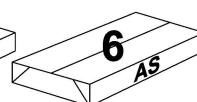
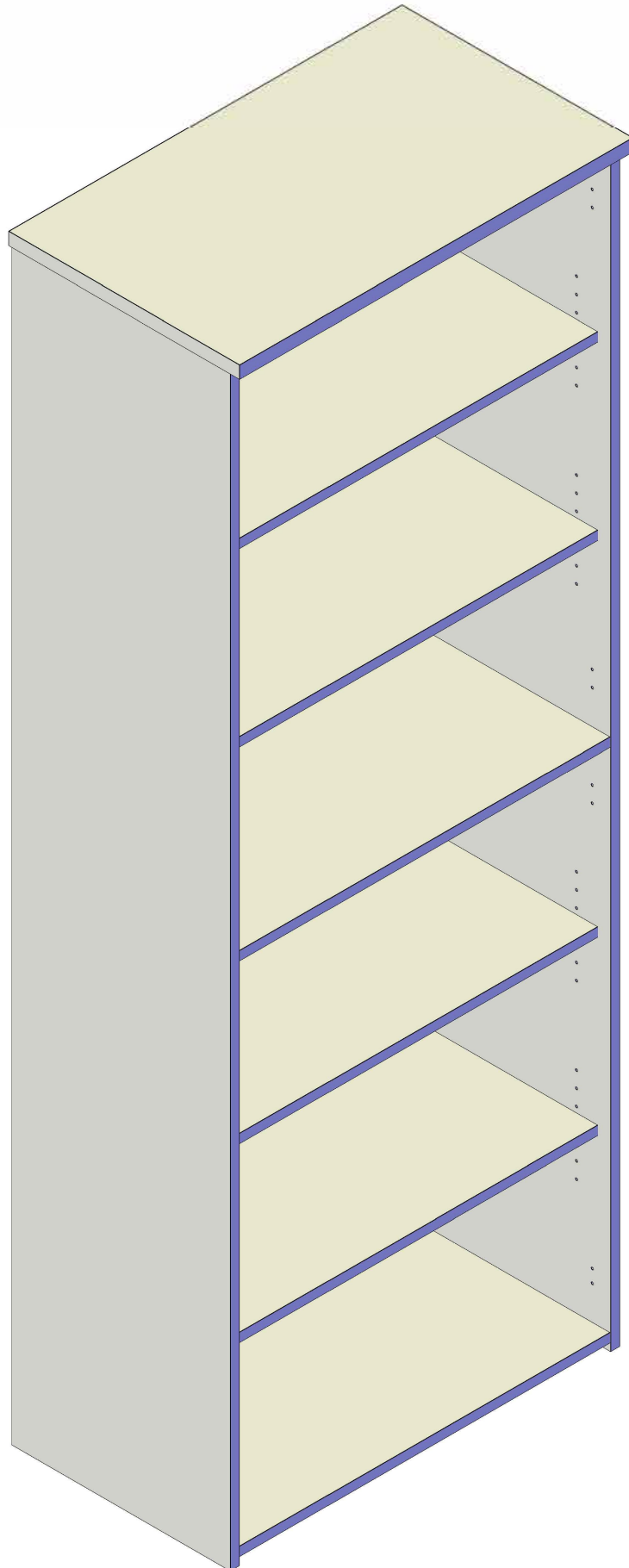
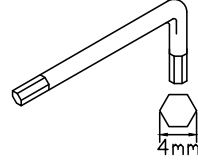
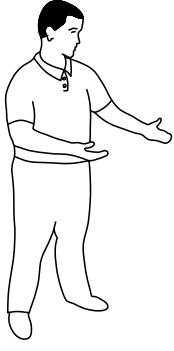

**DONT STRUGGLE
2 MAN LIFT**

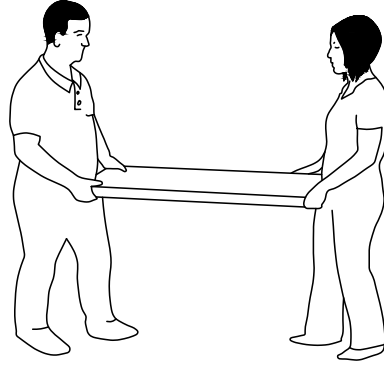
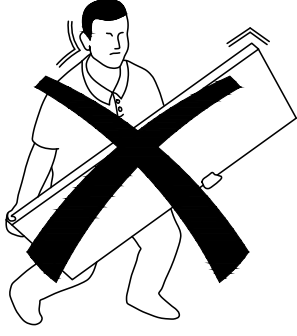

**ALWAYS HANDLE
ITEMS WITH CARE**

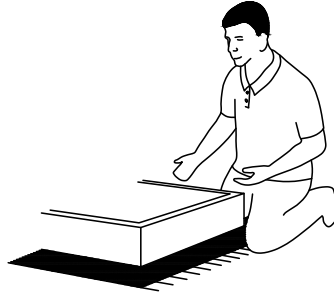
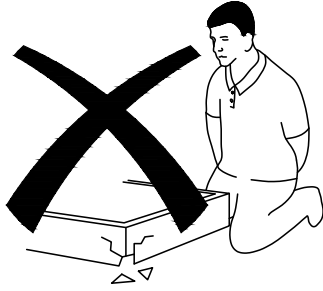

**IF UNSURE CALL
FOR ASSISTANCE**

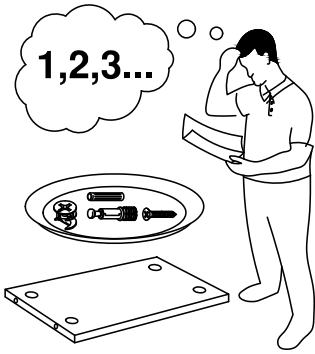

**KEEP FITTINGS AWAY
FROM CHILDREN**

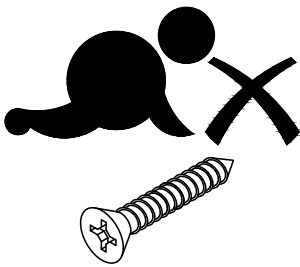



Please check that you have all the panels!

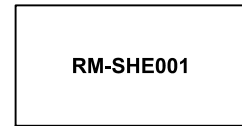
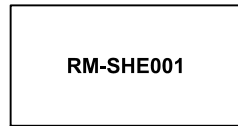
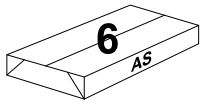
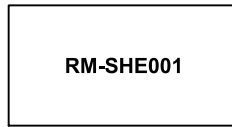
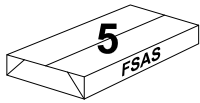
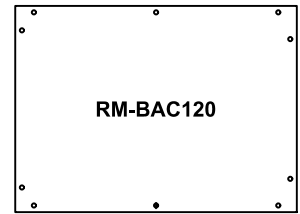
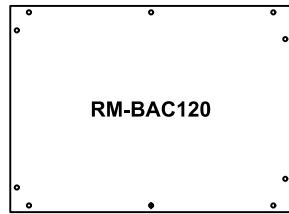
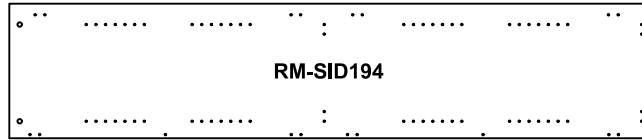
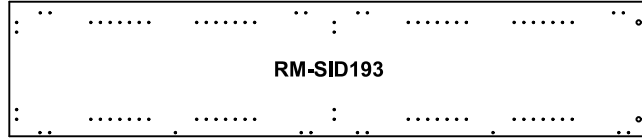
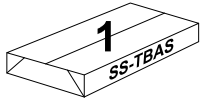

Please check that you have all the fittings!

(Fittings Bags Supplied in Carton 2 - SS-2140S)



16	Cam 15N CAM03		16	24mm Quick fix pin BLT07	
	4	Shelf clip PAR07			12

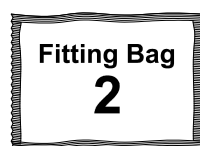

16	Cam 15N CAM03		16	24mm Quick fix pin BLT07	
	4	Shelf clip PAR07			12



20	17mm Cover Caps CAP07	
-----------	--------------------------	--

Prepare all the panels by inserting the listed fittings into the corresponding holes.

1

Prepare the panels by inserting the listed fittings into the corresponding holes.

Insert the cam fittings first before turning the panel over to insert the quick fix pins.

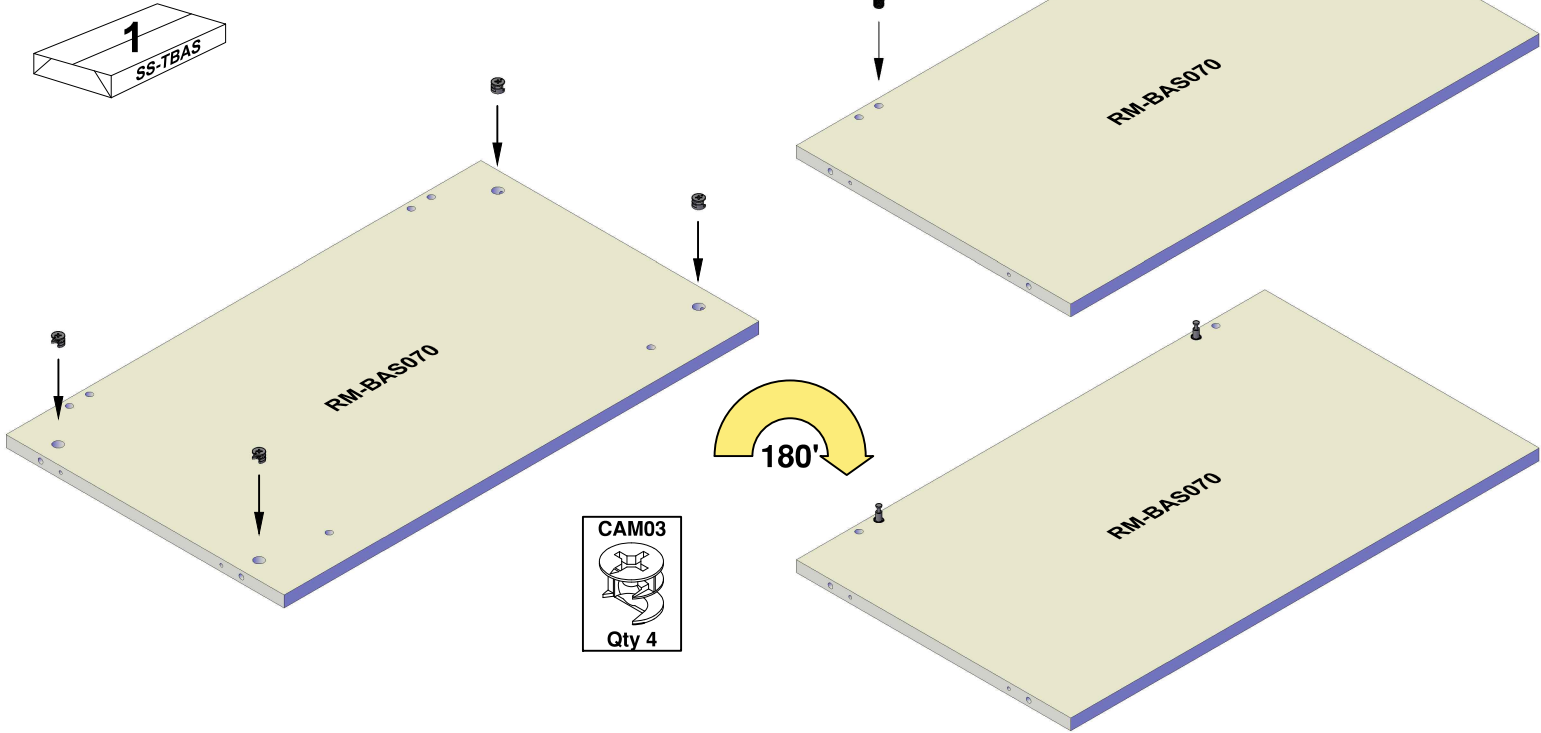

2

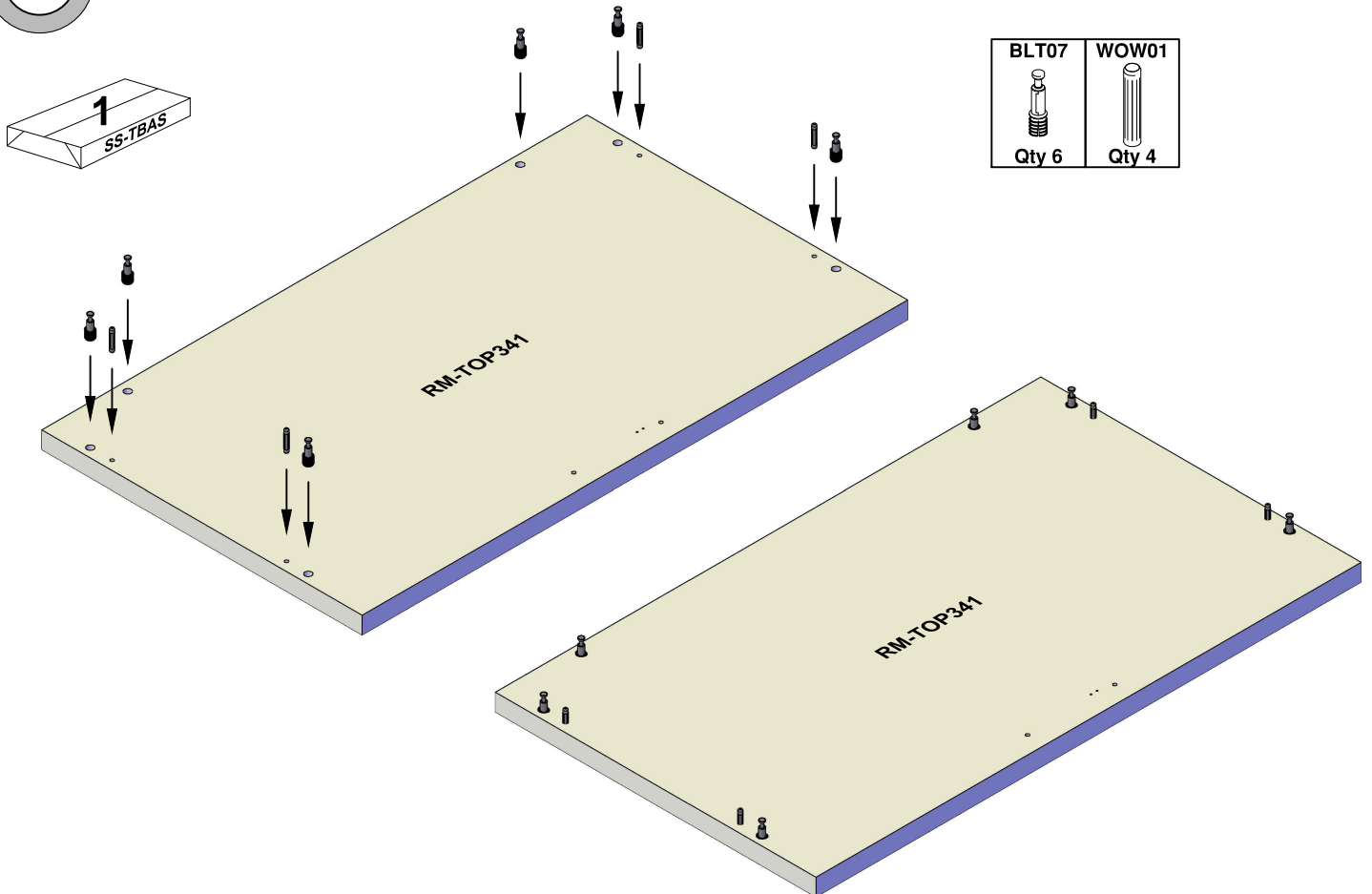

Prepare all the panels by inserting the listed fittings into the corresponding holes.

3

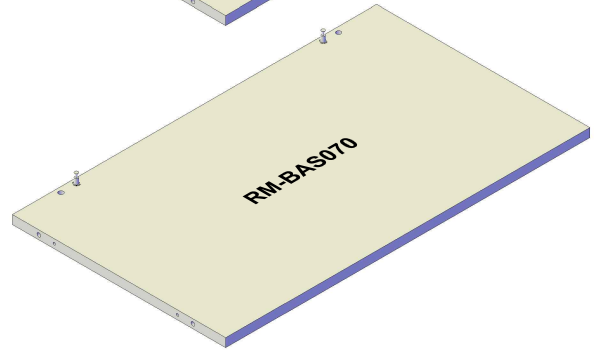
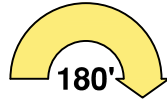
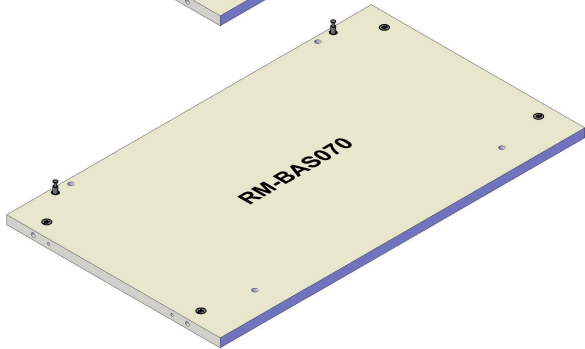
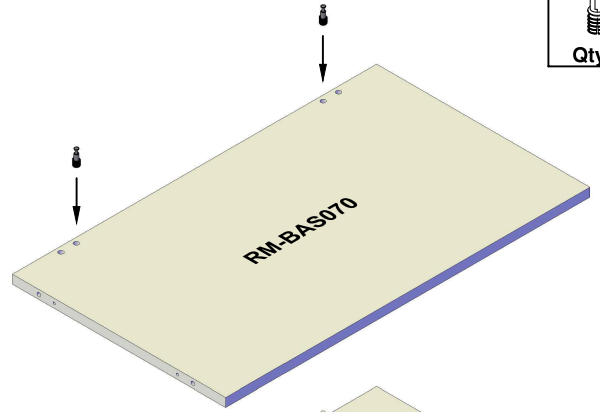
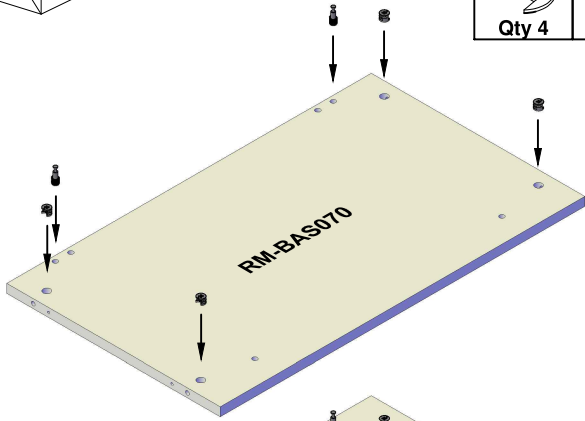
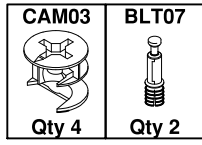
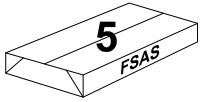

4

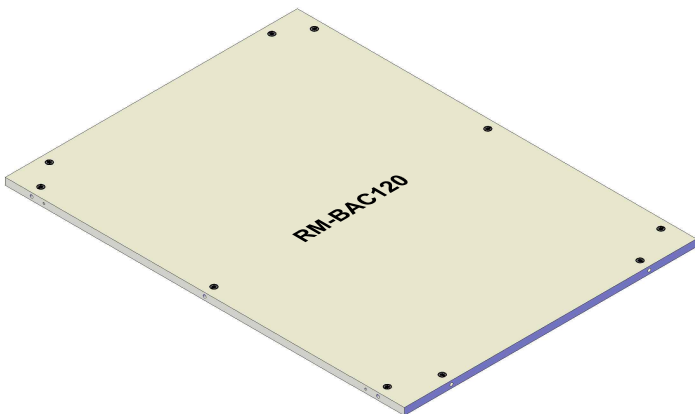
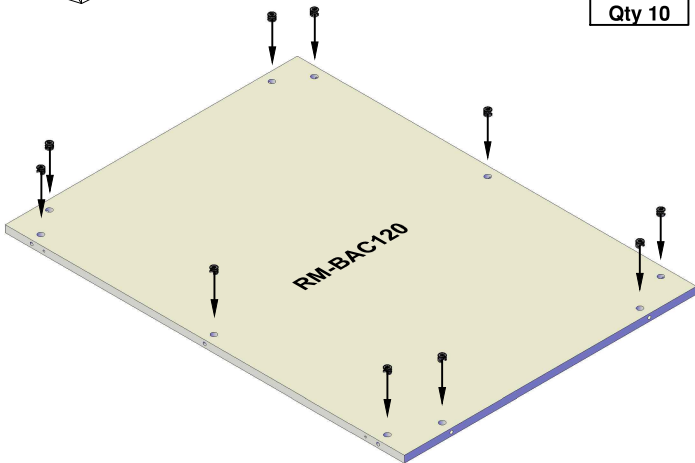



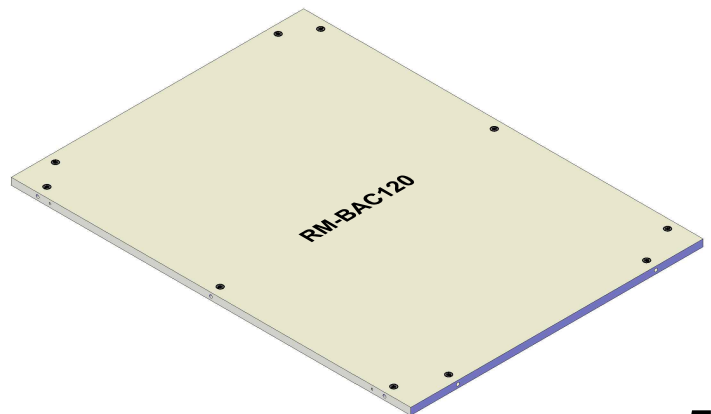
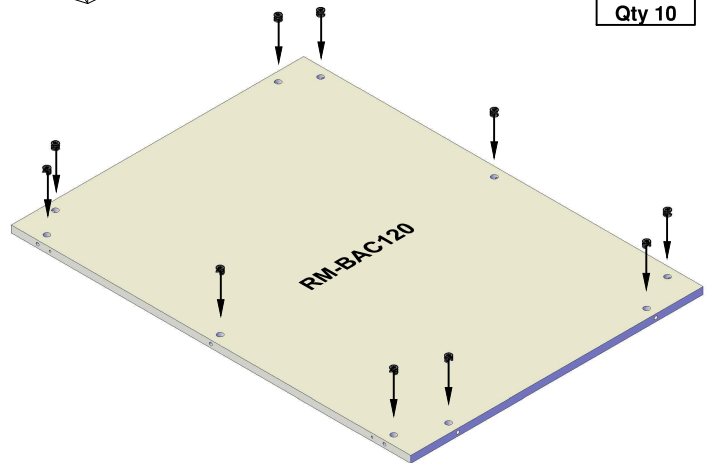

5





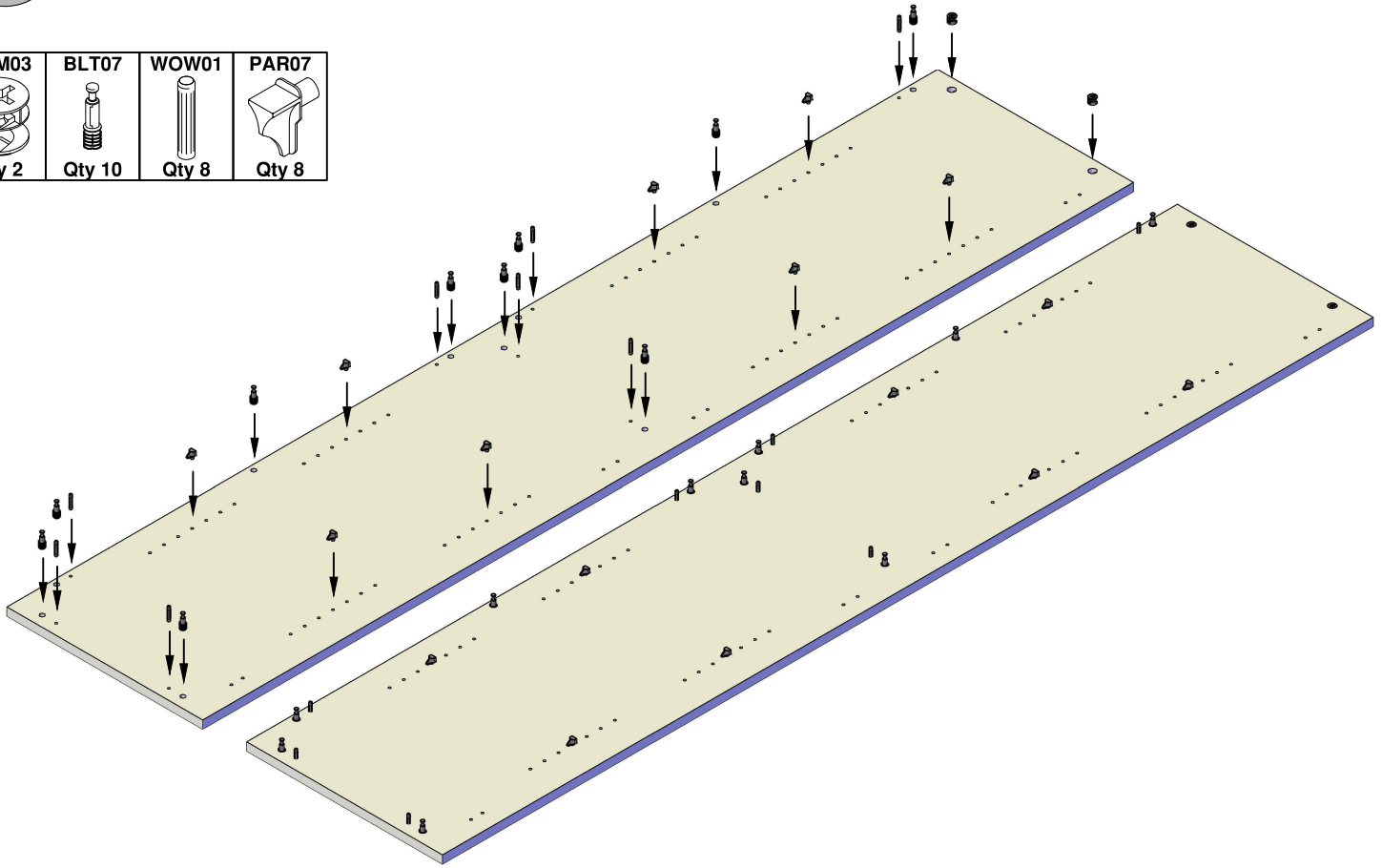

Prepare all the panels by inserting the listed fittings into the corresponding holes.

5

CAM03  Qty 2	BLT07  Qty 10	WOW01  Qty 8	PAR07  Qty 8
---	---	--	--



6

CAM03  Qty 2	BLT07  Qty 10	WOW01  Qty 8	PAR07  Qty 8
---	---	--	--

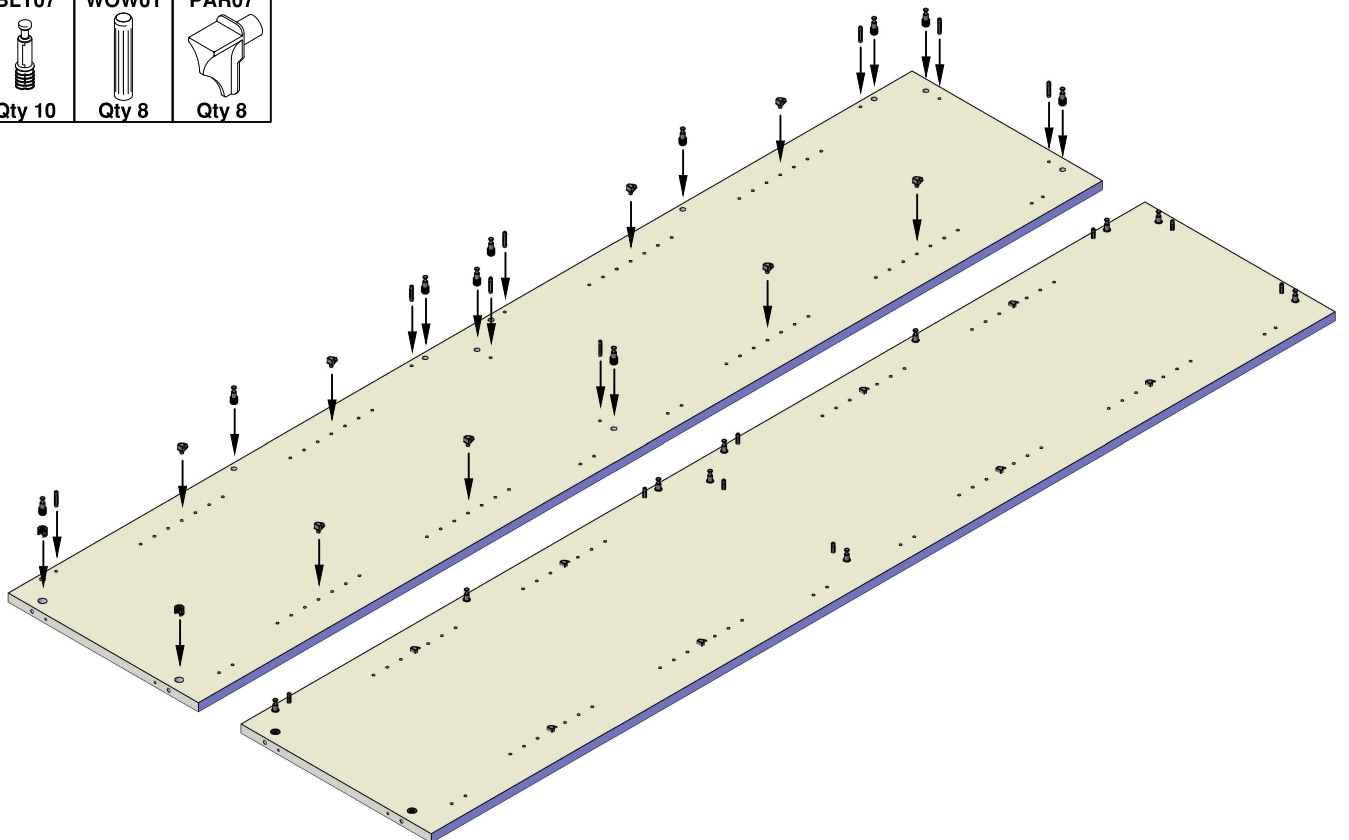

Join the panels together and tighten all cam fittings

7

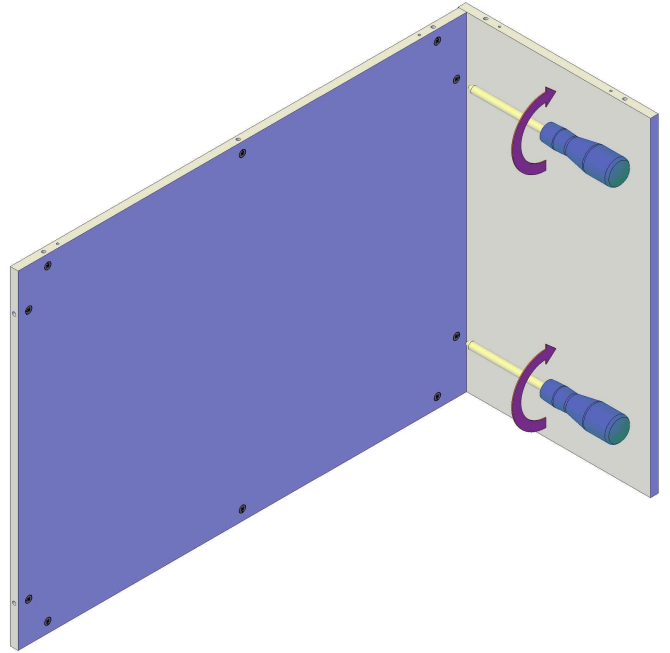
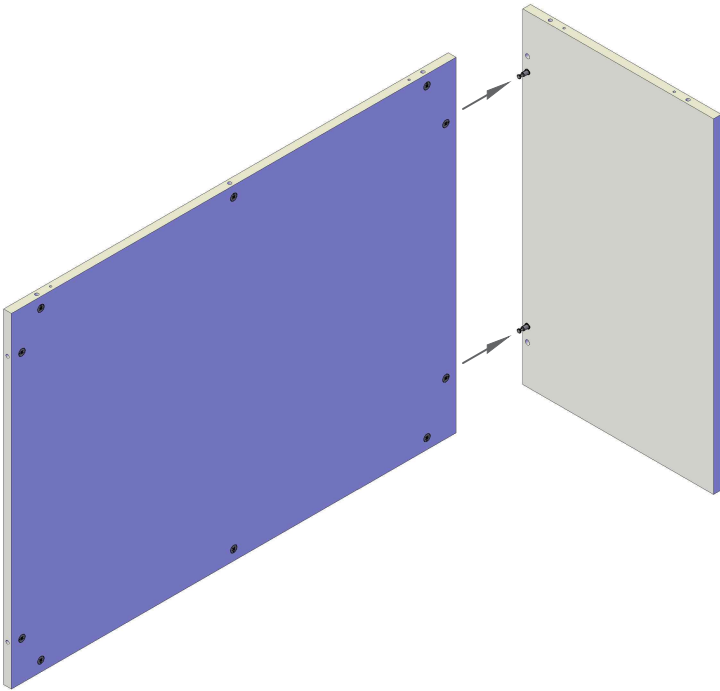

8

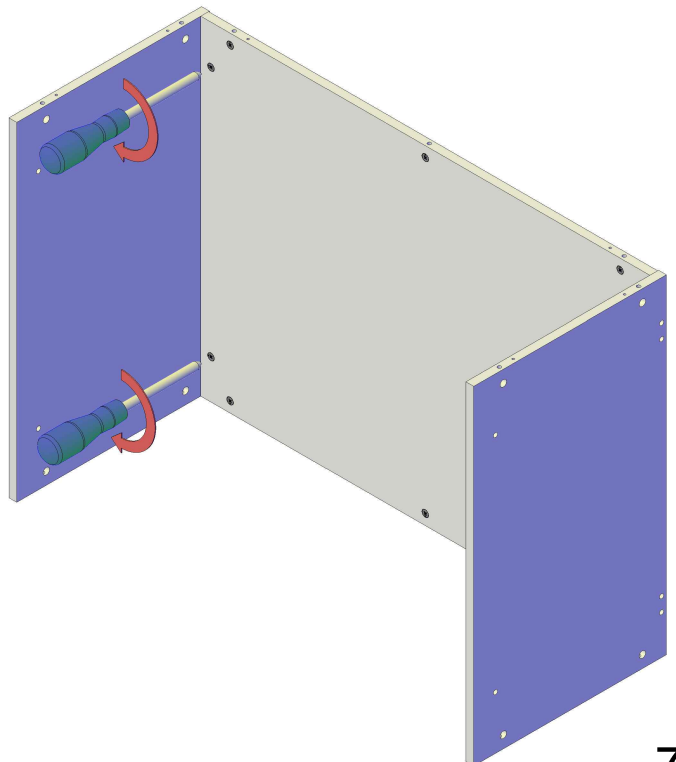
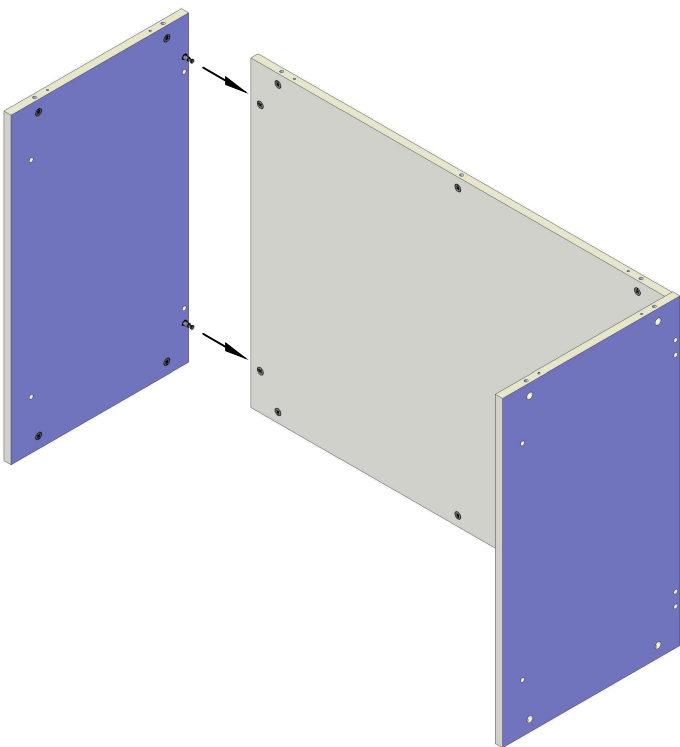

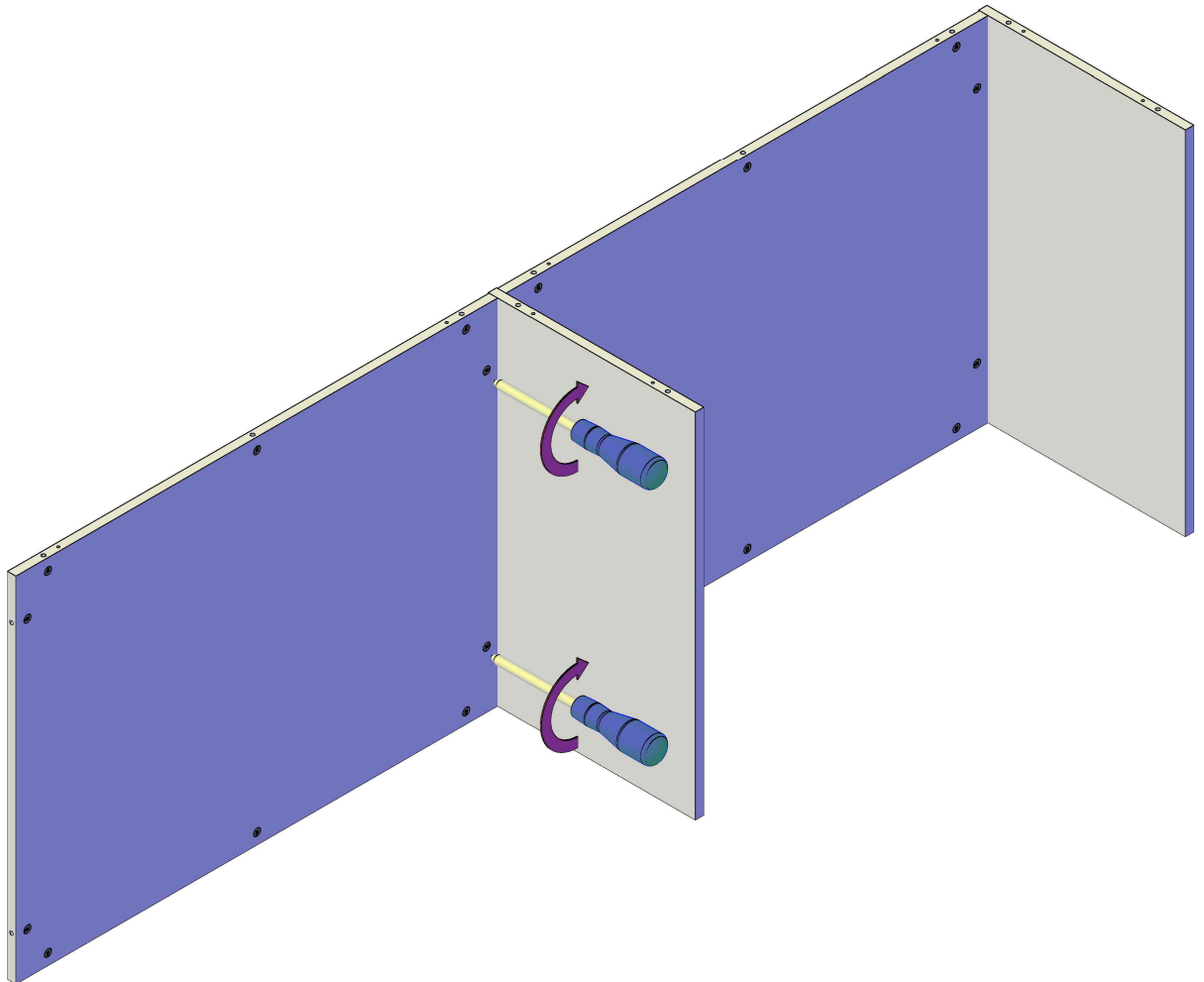
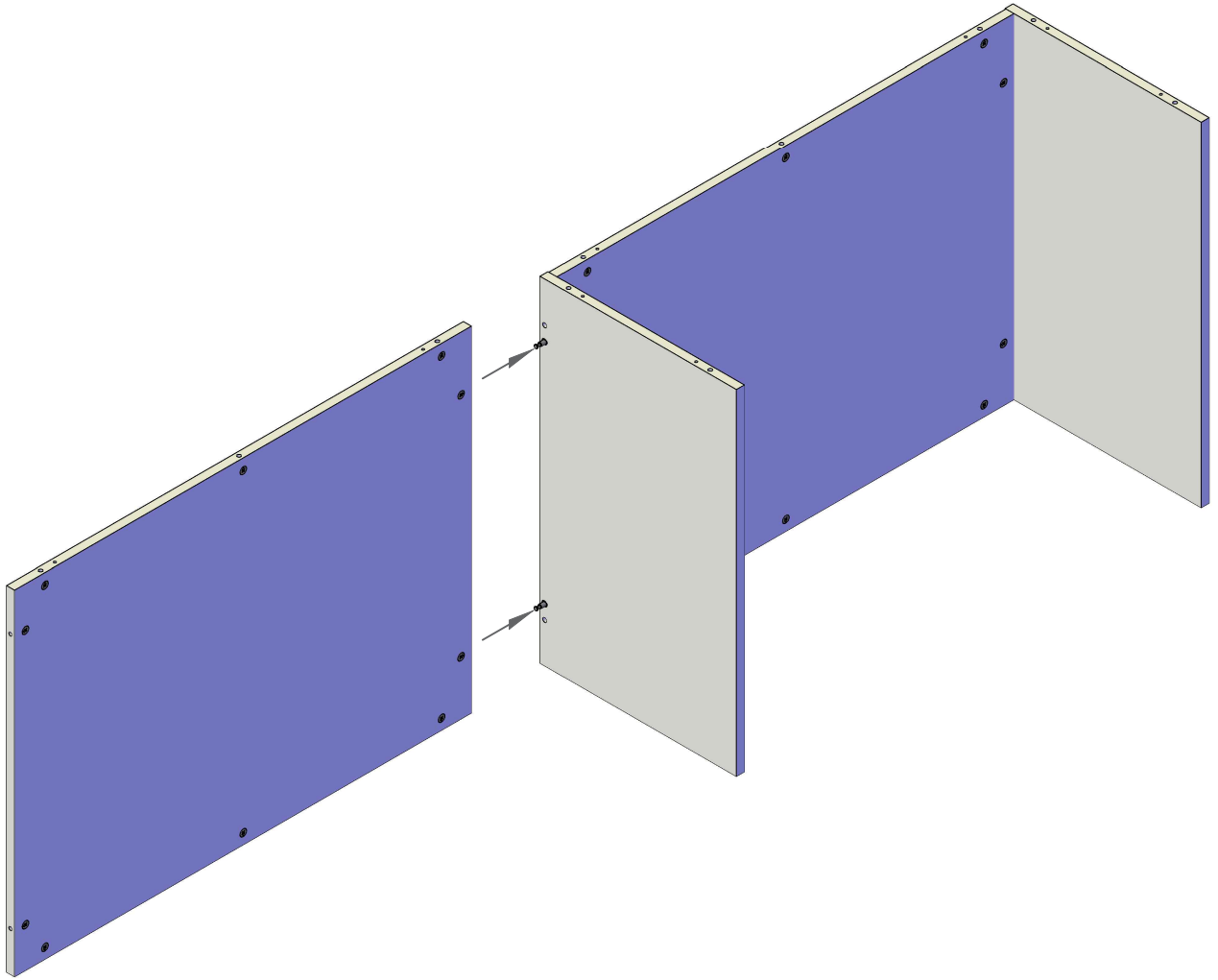

Join the panels together and tighten all cam fittings

10

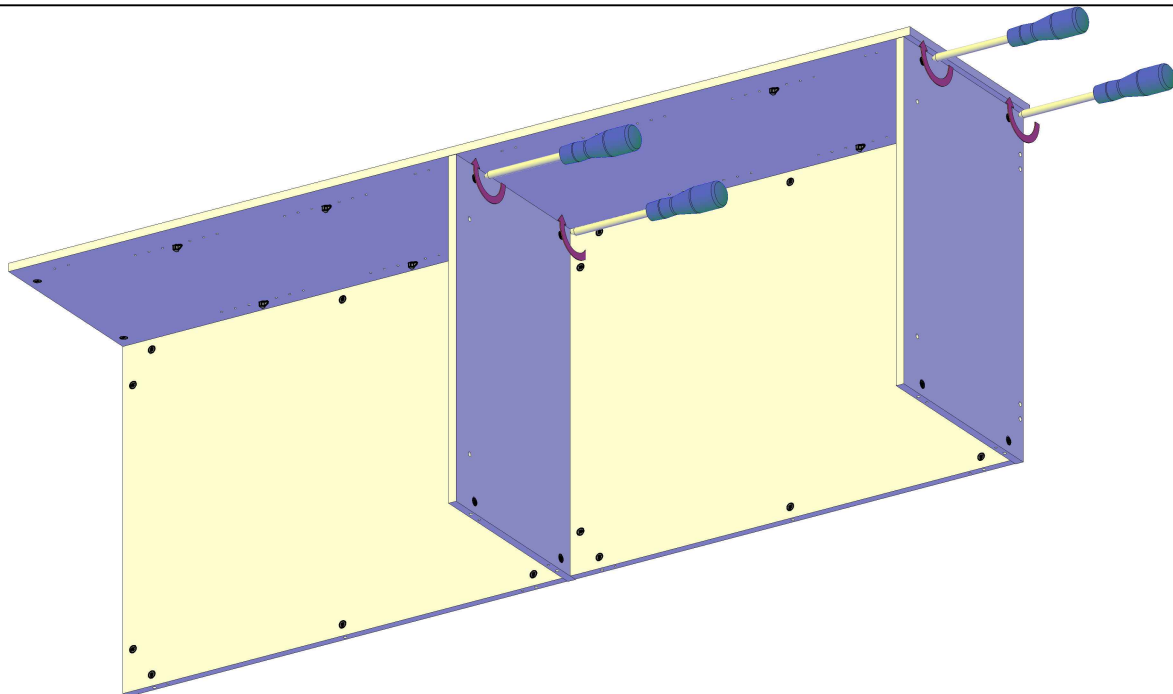
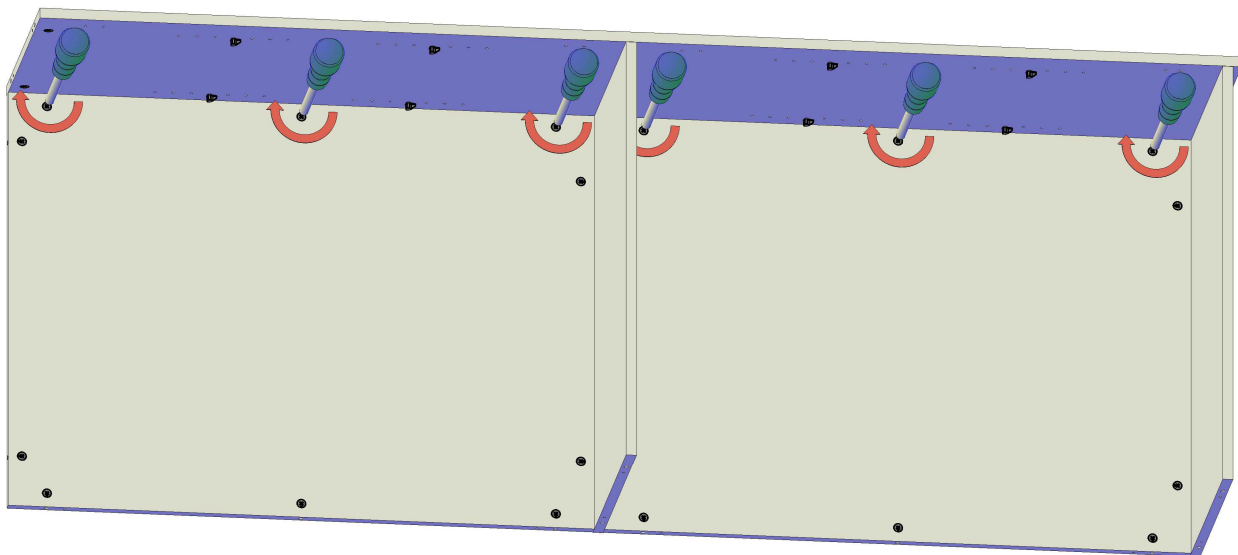
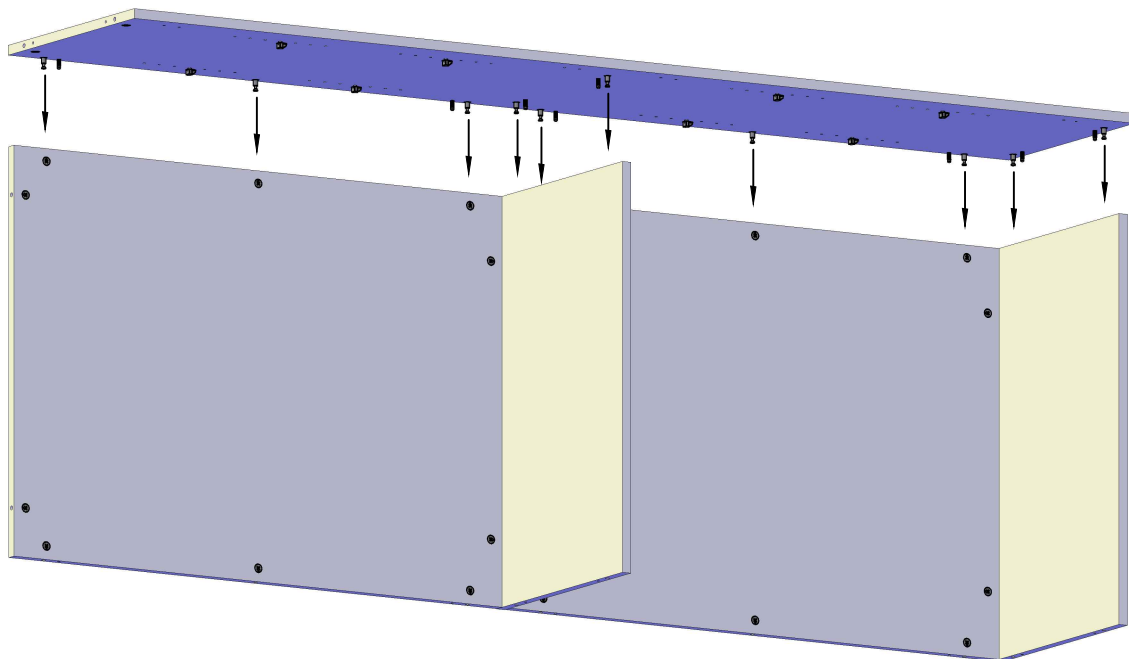

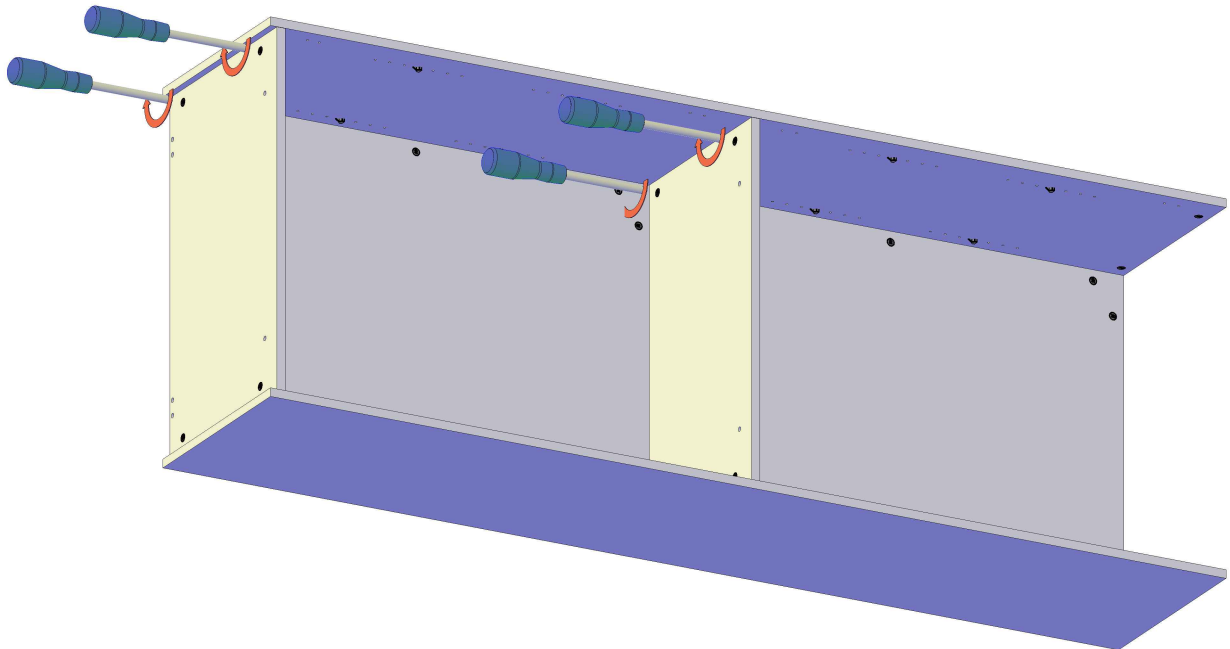
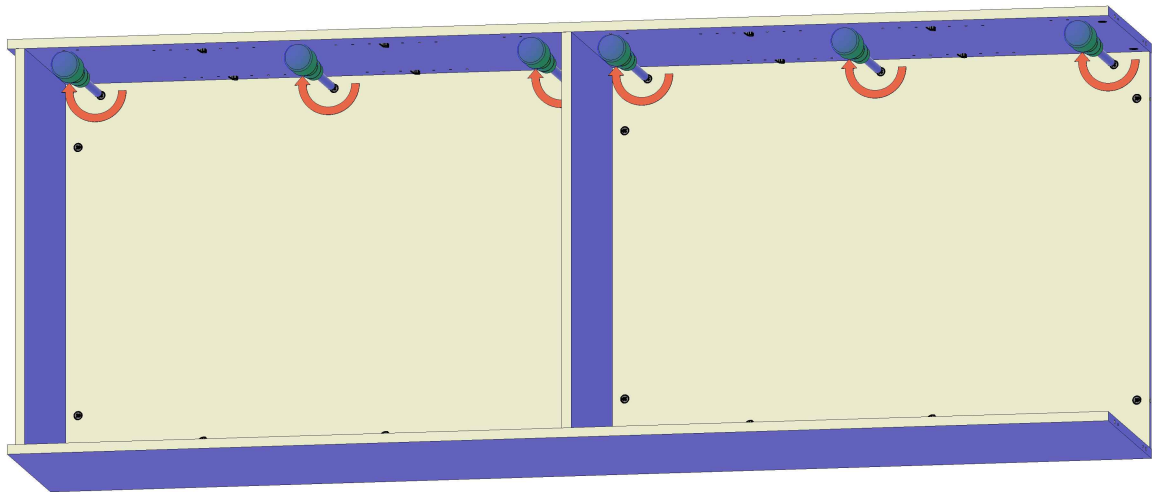
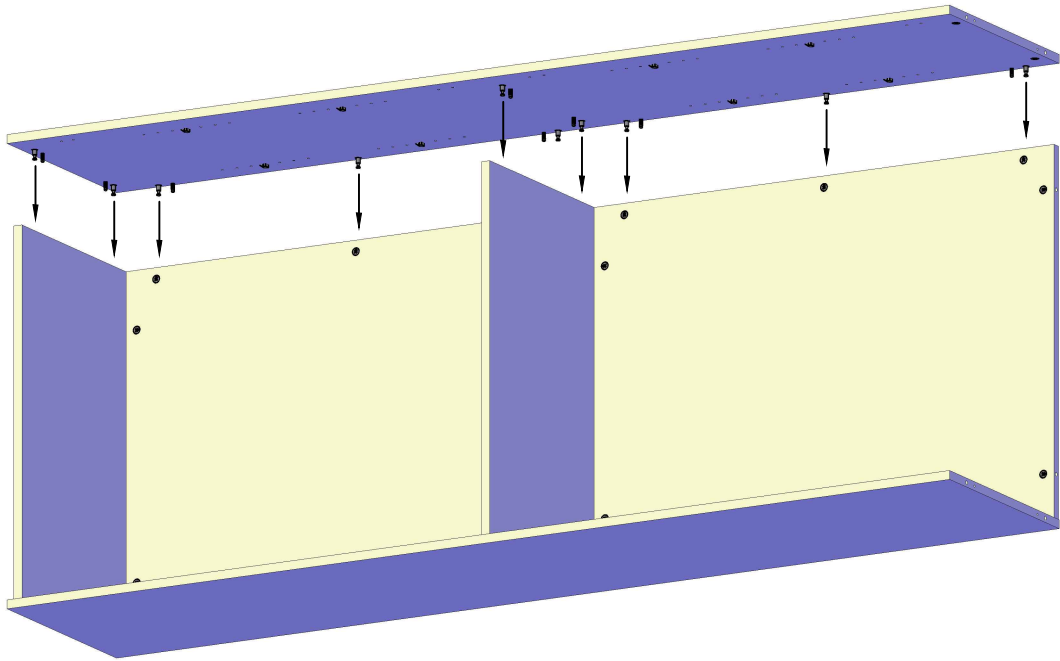

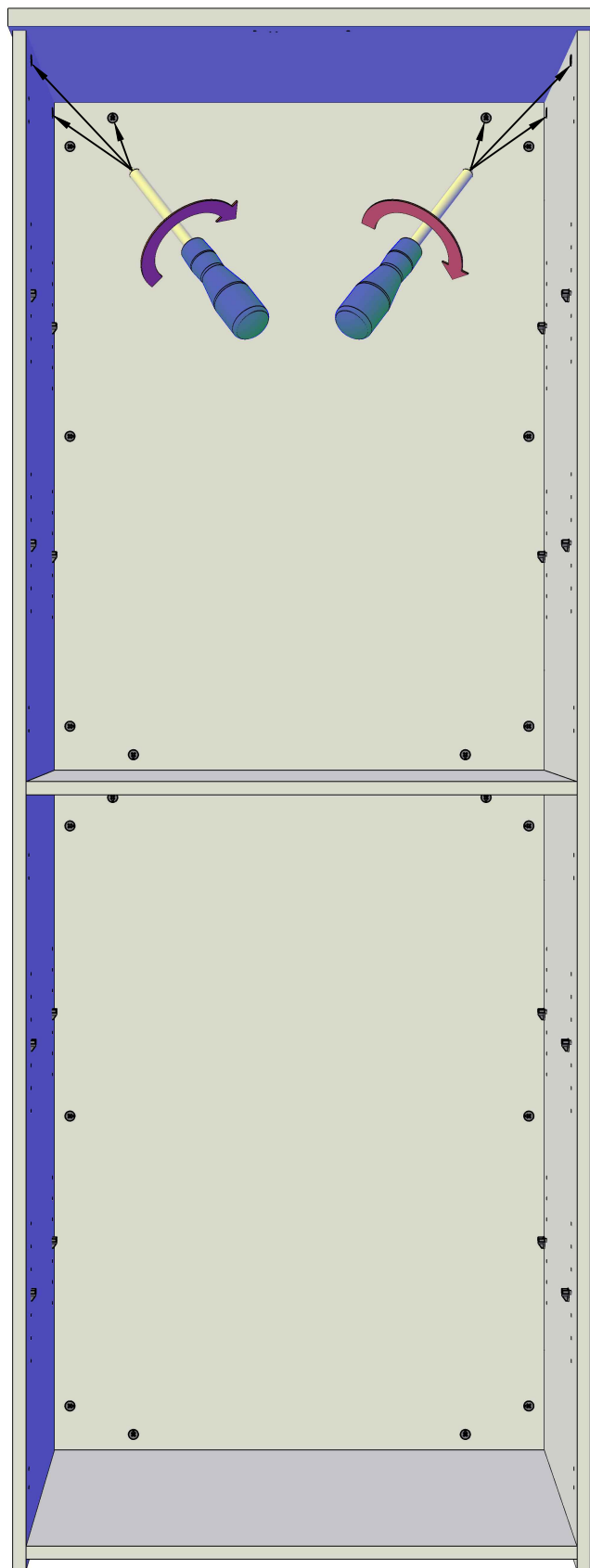
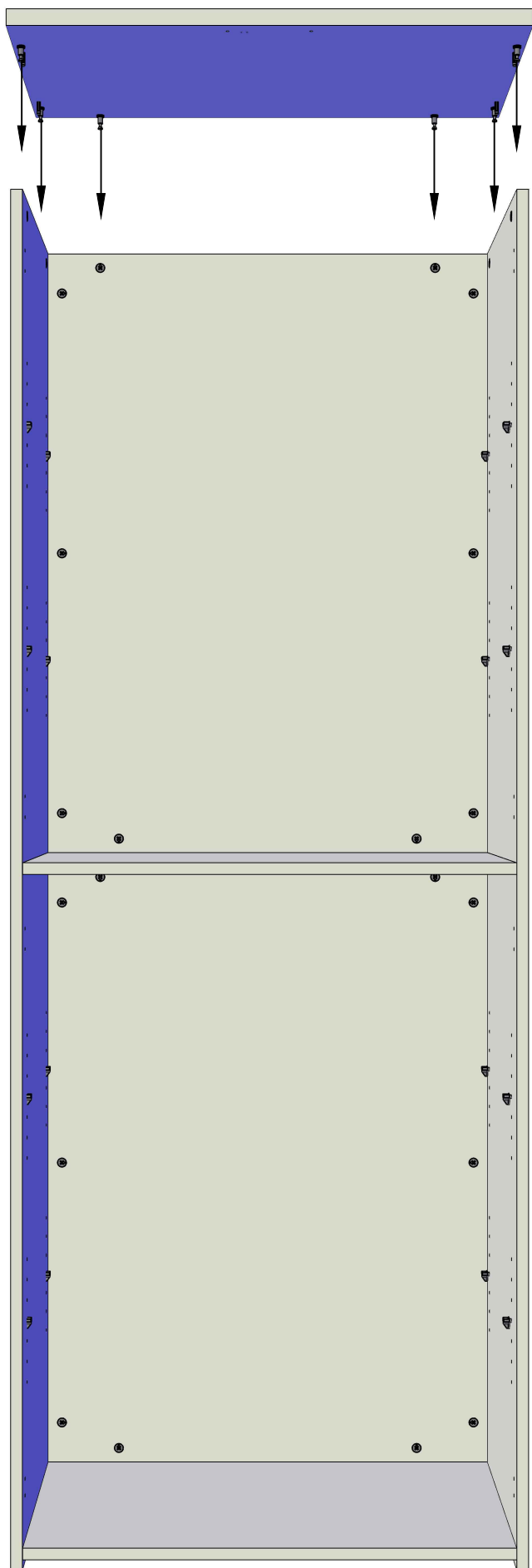

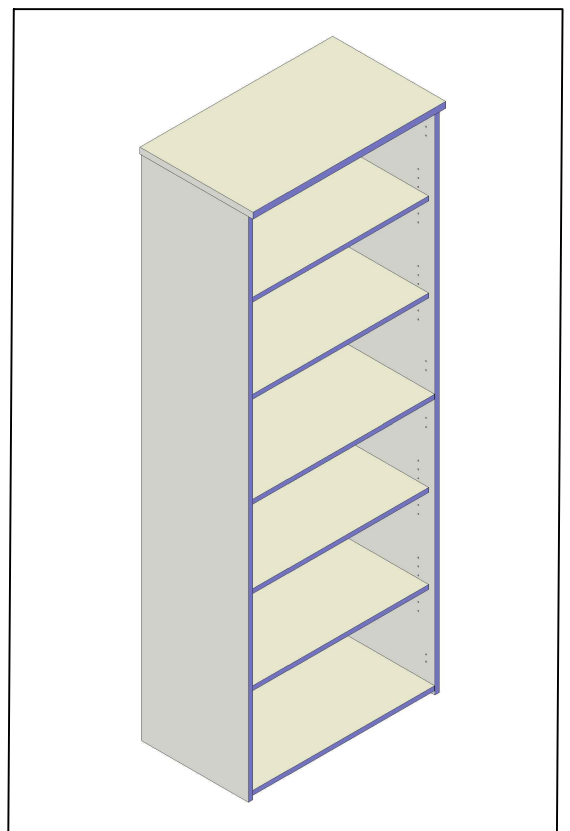
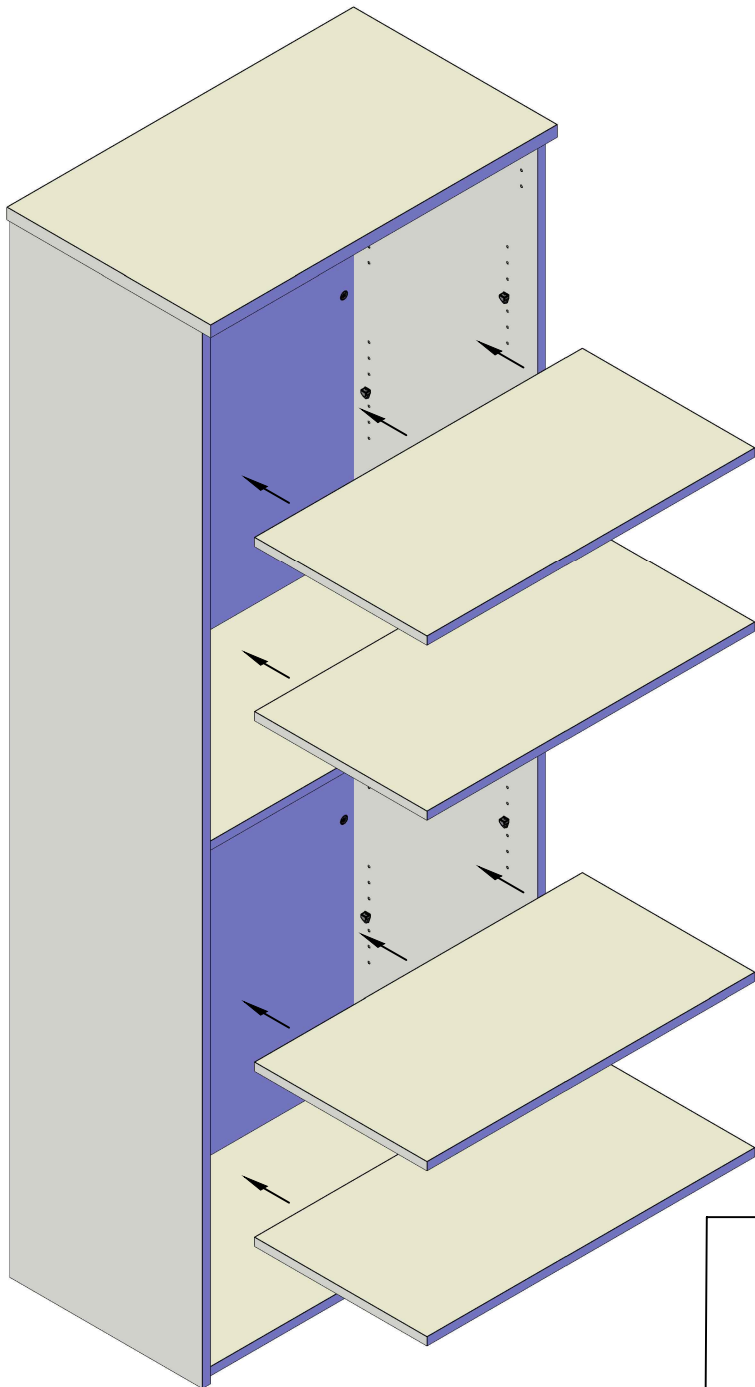







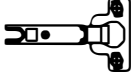

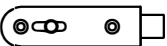
TD
MAESTRO DIRECTIV
CUPBOARD DOORS



	2
	1
	6
	6
	1
	1
	4
	2
	4

1

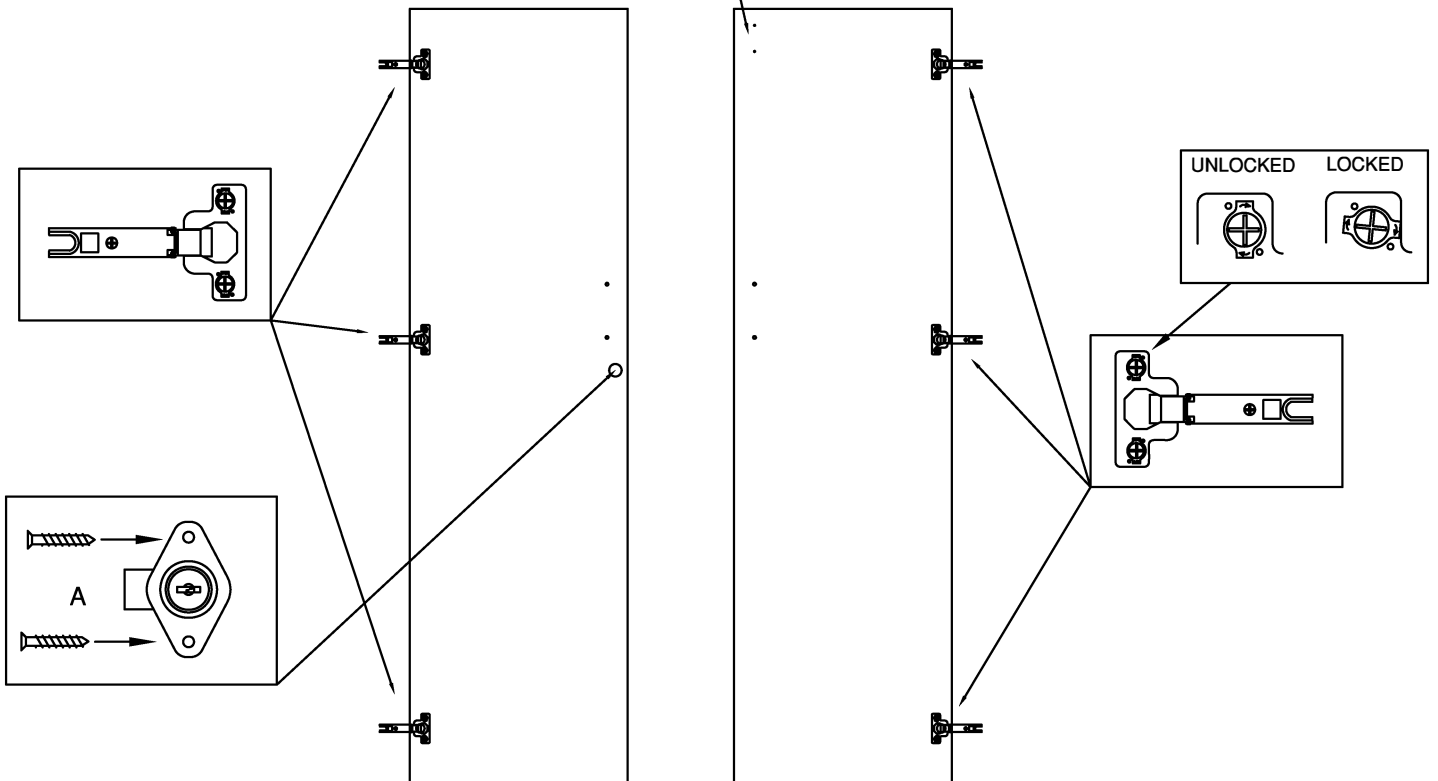
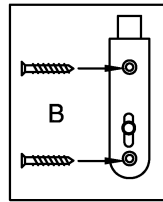

2

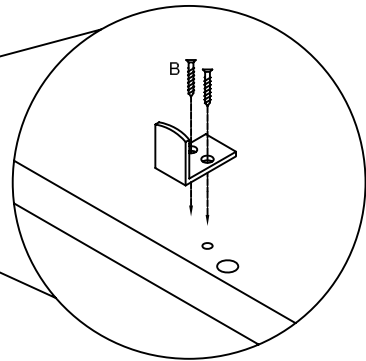
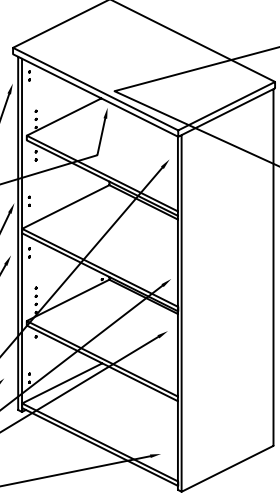
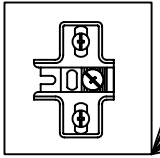
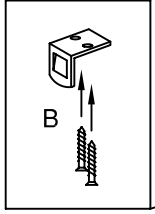

LOCATE PLATE WITH FIRST SCREW AS SHOWN. WITH PLATE PARALLEL TO THE FRONT OF THE TOP SECURE WITH THE SECOND SCREW.

3

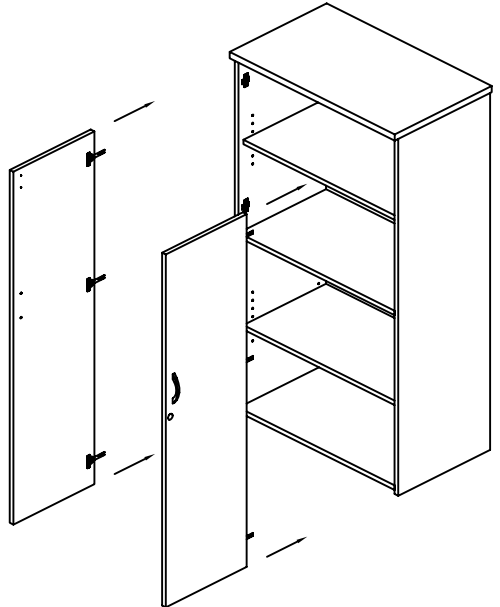

4

