



OLED Monitor
User Manual
AG276QZD2

As an OLED product, this display needs regular screen maintenance to reduce the risk of image retention (burn-in).



Safety	1
Notational Conventions	1
Power	2
Installation	3
Cleaning	4
Other	5
Setup	6
Contents in Box	6
Setup Stand & Base	7
Adjusting the monitor	9
Connecting the Monitor	10
Wall Mounting	11
Adaptive-Sync function	12
HDR	13
Screen Maintenance	14
Adjusting	16
Hotkeys	16
OSD Key Guide (Menu)	17
OSD Setting	19
Game Setting	20
Luminance	22
PIP Setting	24
Audio	26
Light FX	27
Extra	28
OSD Setup	30
LED Indicator	31
Troubleshooting	32
Specification	33
General Specification	33
Preset Display Modes	35
Pin Assignments	36
Plug and Play	37

Safety

Notational Conventions

The following subsections describe notational conventions used in this document.

Notes, Cautions, and Warnings

Throughout this guide, blocks of text may be accompanied by an icon and printed in bold type or in italic type. These blocks are notes, cautions, and warnings, and they are used as follows:



NOTE: A NOTE indicates important information that helps you make better use of your computer system.





CAUTION: A CAUTION indicates either potential damage to hardware or loss of data and tells you how to avoid the problem.





WARNING: A WARNING indicates the potential for bodily harm and tells you how to avoid the problem. Some warnings may appear in alternate formats and may be unaccompanied by an icon. In such cases, the specific presentation of the warning is mandated by regulatory authority.

Power

 The monitor should be operated only from the type of power source indicated on the label. If you are not sure of the type of power supplied to your home, consult your dealer or local power company.

 The monitor is equipped with a three-pronged grounded plug, a plug with a third (grounding) pin. This plug will fit only into a grounded power outlet as a safety feature. If your outlet does not accommodate the three-wire plug, have an electrician install the correct outlet, or use an adapter to ground the appliance safely. Do not defeat the safety purpose of the grounded plug.

 Unplug the unit during a lightning storm or when it will not be used for long periods of time. This will protect the monitor from damage due to power surges.

 Do not overload power strips and extension cords. Overloading can result in fire or electric shock.

 To ensure satisfactory operation, use the monitor only with UL listed computers which have appropriate configured receptacles marked between 100-240V AC, Min. 5A.

 The wall socket shall be installed near the equipment and shall be easily accessible.

 For use only with the attached power adapter

Manufacturers: TPV Electronics(Fujian) Co., Ltd.

Model: ADPC19135

Installation

! Do not place the monitor on an unstable cart, stand, tripod, bracket, or table. If the monitor falls, it can injure a person and cause serious damage to this product. Use only a cart, stand, tripod, bracket, or table recommended by the manufacturer or sold with this product. Follow the manufacturer's instructions when installing the product and use mounting accessories recommended by the manufacturer. A product and cart combination should be moved with care.

! Never push any object into the slot on the monitor cabinet. It could damage circuit parts causing a fire or electric shock. Never spill liquids on the monitor.

! Do not place the front of the product on the floor.

! If you mount the monitor on a wall or shelf, use a mounting kit approved by the manufacturer and follow the kit instructions.

! Leave some space around the monitor as shown below. Otherwise, air-circulation may be inadequate hence overheating may cause a fire or damage to the monitor.

! To avoid potential damage, for example the panel peeling from the bezel, ensure that the monitor does not tilt downward by more than -5 degrees. If the -5 degree downward tilt angle maximum is exceeded, the monitor damage will not be covered under warranty.

See below the recommended ventilation areas around the monitor when the monitor is installed -on the stand:

Installed with stand

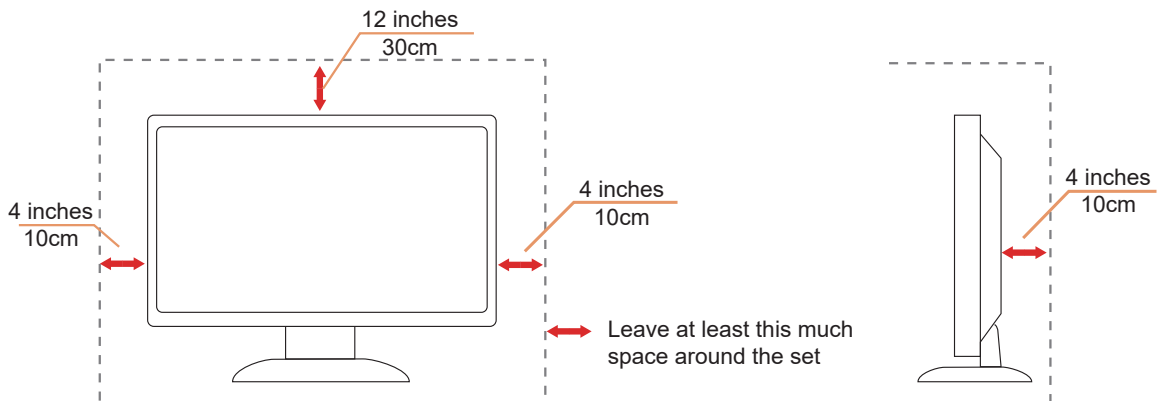

Cleaning

! Clean the cabinet regularly with a water-dampened, soft cloth.

! When cleaning use a soft cotton or microfiber cloth. The cloth should be damp and almost dry, do not allow liquid into the case.



! Please disconnect the power cord before cleaning the product.

Other

 If the product is emitting a strange smell, sound or smoke, disconnect the power plug IMMEDIATELY and contact a Service Center.

 Make sure that the ventilating openings are not blocked by a table or curtain.

 Do not engage the OLED monitor in severe vibration or high impact conditions during operation.

 Do not knock or drop the monitor during operation or transportation.

 It is not recommended to use this OLED product for more than four continuous hours. Possible image retention (burn-in) may occur beyond this usage duration. To reduce the probability of image retention this product uses a number of technologies A maintenance cycle takes about 10 minutes. For details, refer to the “Screen Maintenance” section.

Setup

Contents in Box

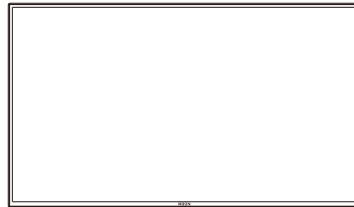

Quick Start

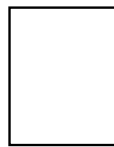

Warranty card



Stand

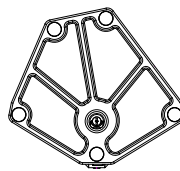

Base

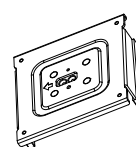

Wall Mount Bracket

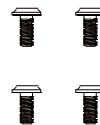

Stand Screws



Screwdriver



Power Cable



Adaptor



DP Cable



HDMI Cable



USB Cable

* Not all signal cables will be provided for all countries and regions. Please check with the local dealer or AOC branch office for confirmation.

Setup Stand & Base

Please setup or remove the base following the steps as below.

Setup:

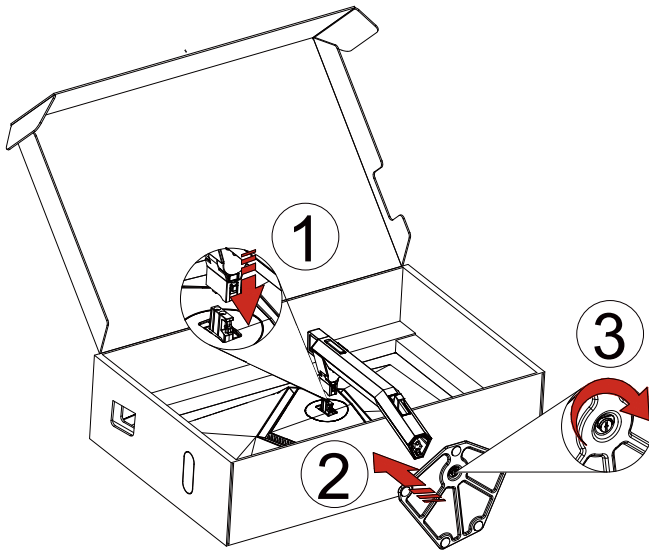

Remove:

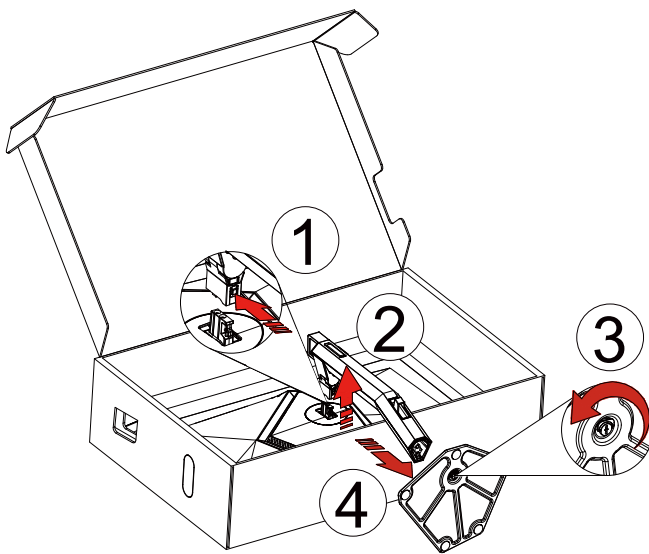

Wall hanger:

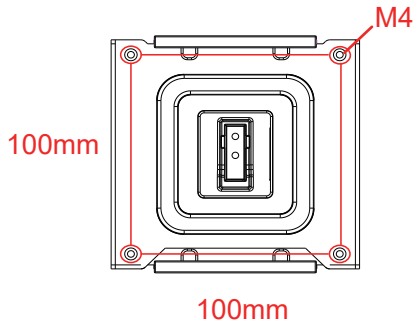

Specification of wall hanger screws: M4*12mm

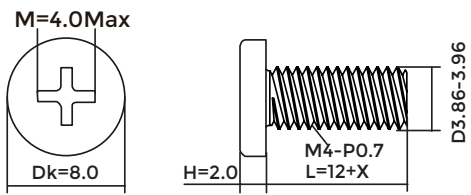

Specification for base screw: M6*12 mm (effective thread 5.5 mm)

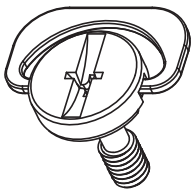

Adjusting the monitor

For optimal viewing it is recommended to look at the full face of the monitor, then adjust the monitor's angle to your own preference.

Hold the stand to steady the monitor, and grasp only the bezel to adjust the monitor's angle.

You are able to adjust the monitor as below:

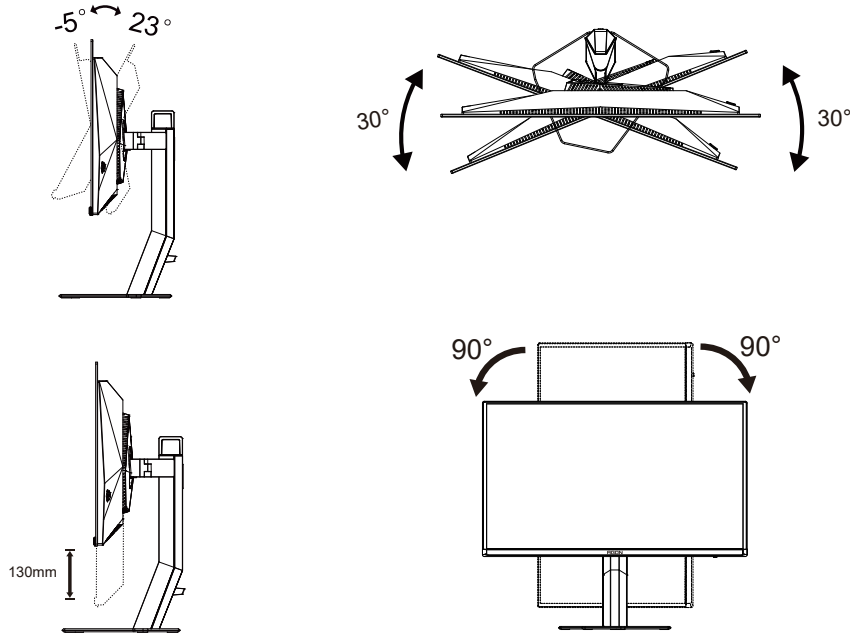

 **NOTE:**

Do not touch the OLED screen when you change the angle. Touching the OLED screen may cause damage.

Warning :

1. To avoid potential screen damage, such as panel peeling, ensure that the monitor does not tilt downward by more than -5 degrees.
2. Do not press the screen while adjusting the angle of the monitor. Grasp only the bezel.

Connecting the Monitor

Cable Connections In Back of Monitor:

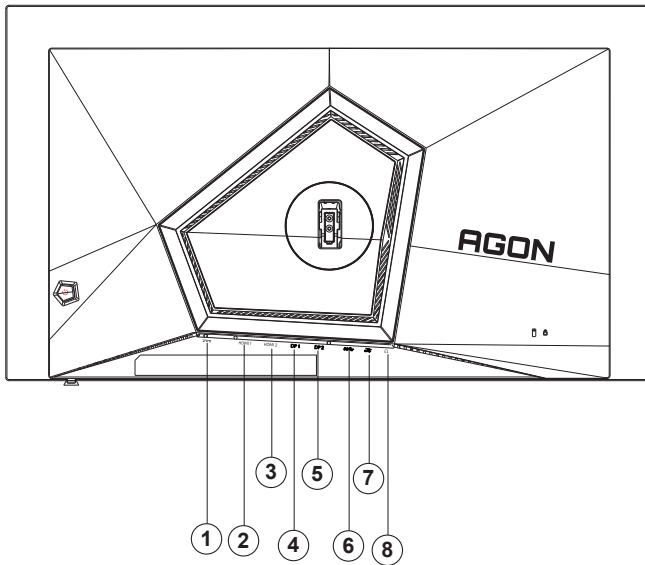

1. Power
2. HDMI1
3. HDMI2
4. DP1
5. DP2
6. USB3.2 Gen1 upstream
7. USB3.2 Gen1 downstream + fast charging
USB3.2 Gen1 downstream x1
8. Earphone

Connect to PC

1. Connect the power cord to the back of the display firmly.
2. Turn off your computer and unplug its power cable.
3. Connect the display signal cable to the video connector on your computer.
4. Plug the power cord of your computer and your display into a nearby outlet.
5. Turn on your computer and display.

If your monitor displays an image, installation was successful and is complete. If your monitor does not display an image, please refer to the “Troubleshooting” section.

To protect equipment, always turn off the PC and OLED monitor before connecting.

Wall Mounting

Preparing to Install An Optional Wall Mounting Arm.

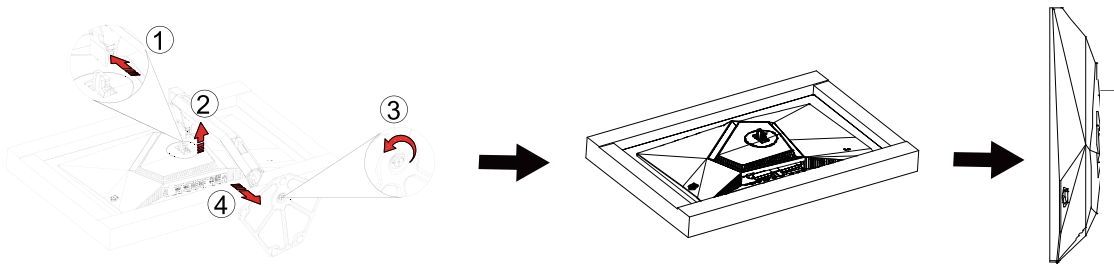

This monitor can be attached to a wall mounting arm you purchase separately. Disconnect power before this procedure. Follow these steps:

1. Remove the base.
2. Follow the manufacturer's instructions to assemble the wall mounting arm.
3. Place the wall mounting arm onto the back of the monitor. Line up the holes of the arm with the holes in the back of the monitor.
4. Reconnect the cables. Refer to the user's manual that came with the optional wall mounting arm for instructions on attaching it to the wall.



Noted: VESA mounting screw holes are not available for all models, please check with the dealer or official department of AOC.

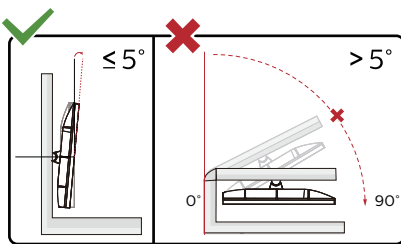

Display design may differ from those illustrated.

Warning :

1. To avoid potential screen damage, such as panel peeling, ensure that the monitor does not tilt downward by more than -5 degrees.
2. Do not press the screen while adjusting the angle of the monitor. Grasp only the bezel.

Adaptive-Sync function

1. Adaptive-Sync function is working with DP/HDMI
2. Compatible Graphics Card: Recommend list is as the below, also could be checked by visiting www.AMD.com

Graphics Cards

- Radeon™ RX Vega series
- Radeon™ RX 500 series
- Radeon™ RX 400 series
- Radeon™ R9/R7 300 series (R9 370/X, R7 370/X, R7 265 except)
- Radeon™ Pro Duo (2016)
- Radeon™ R9 Nano series
- Radeon™ R9 Fury series
- Radeon™ R9/R7 200 series (R9 270/X, R9 280/X except)

Processors

- AMD Ryzen™ 7 2700U
- AMD Ryzen™ 5 2500U
- AMD Ryzen™ 5 2400G
- AMD Ryzen™ 3 2300U
- AMD Ryzen™ 3 2200G
- AMD PRO A12-9800
- AMD PRO A12-9800E
- AMD PRO A10-9700
- AMD PRO A10-9700E
- AMD PRO A8-9600
- AMD PRO A6-9500
- AMD PRO A6-9500E
- AMD PRO A12-8870
- AMD PRO A12-8870E
- AMD PRO A10-8770
- AMD PRO A10-8770E
- AMD PRO A10-8750B
- AMD PRO A8-8650B
- AMD PRO A6-8570
- AMD PRO A6-8570E
- AMD PRO A4-8350B
- AMD A10-7890K
- AMD A10-7870K
- AMD A10-7850K
- AMD A10-7800
- AMD A10-7700K
- AMD A8-7670K
- AMD A8-7650K
- AMD A8-7600
- AMD A6-7400K

HDR

This monitor is compatible with HDR10 formatted input signals.

The display may automatically activate the HDR function if the player and content are compatible. Please contact the device manufacturer and the content provider for information on the compatibility of your device and content. If you have no need for the automatically activated HDR functions, please select "OFF" from the display settings menu.

Note:

1. 3840x2160@50Hz/60Hz is only available on devices such as UHD players or Xbox/PS.
2. Display Settings:
 - a. The display resolution is set to 2560x1440, and HDR is preset to ON. Under these conditions, the screen may slightly dim, indicating HDR has been activated.
 - b. After entering an application, the best HDR effect can be achieved when the resolution is changed to 2560x1440 (if available).

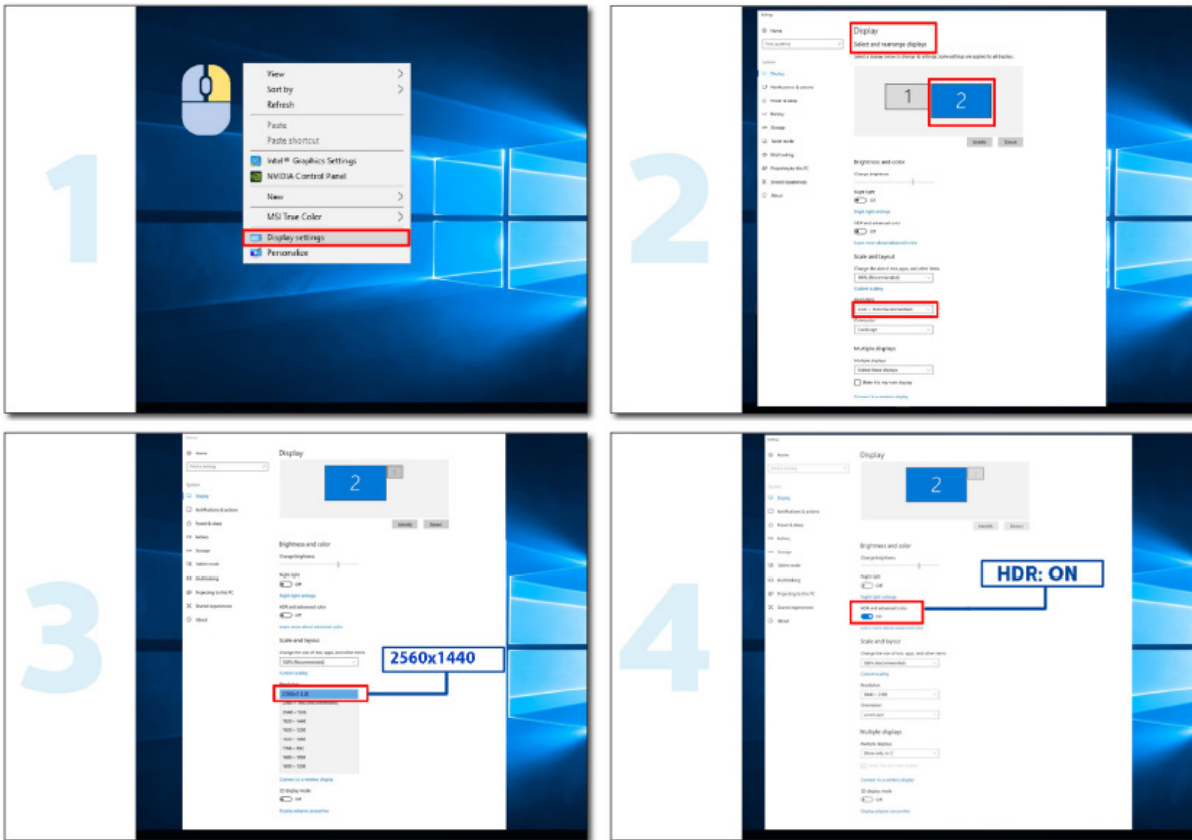

Screen Maintenance

To reduce the risk of image retention on the screen, regularly conduct the following maintenance. Not following these instructions may void your warranty.

• Avoid displaying a still image for extended periods.

A still image refers to an image that does not change over time, such as a photograph.

A still image may result in permanent damage to the OLED screen, causing the image to continue to appear when no longer actively being shown.

For best results:

1. No Static Images. Do not display a still image for an extended time (4 hours). This may cause screen image residue (burn-in). If an image needs to be displayed for an extended time, reduce the brightness and contrast as much as possible.
2. Use Full Screen. When watching video that is letterboxed or pillar-boxed, such as 4:3 video, may result in artifacts. Use full screen mode to reduce this issue.
3. No Stickers. Do not put labels or stickers directly on the screen. This may cause screen damage.

• Do not use this display for more than four hours continuously.

This product uses many technologies to reduce or eliminate image retention (burn-in). Use the default screen settings to avoid image retention and maintain image quality.

• Pixel Orbiting (Image Shift)

Orbit will slightly shift the displayed image at the pixel level, once a second to prevent image retention.

This function is “On (Weak)” by default, “Weak” moves the least, “Strong” moves the most, “Off” disables the movement and increases the chance of image retention. This can be set in the OSD menu.

• Panel Refresh (Screen compensation and correction) / Pixel Refresh (Off Real Slow)

OLED displays begin to show image retention when a still image is displayed for a long time, about 4 hours of continuous use.

To eliminate image residue that is beginning to appear, run the screen compensation correction and image residue elimination functions regularly for best display performance.

Maintenance cycle

You may run this function in one of the following ways:

- 1). From the OSD menu, manually turn on the image residue elimination function, and select “Yes” from the menu.

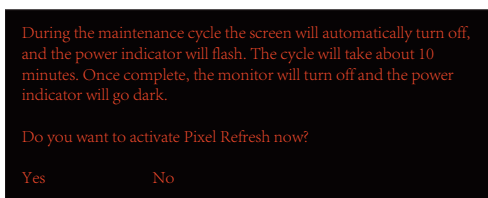

- 2). From the warning message dialog that appears after every 4 hours of cumulative operation, and select “Yes.”

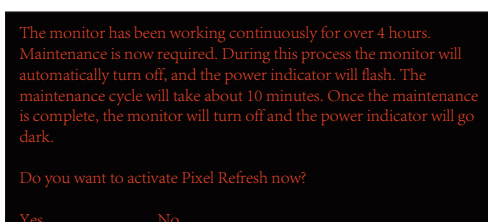

After every 4 hours of cumulative operation, the screen compensation correction and image residue elimination function will automatically run when the display is turned off, or has been in standby for 2 hours.

During this operation keep the power on.

The monitor will first run the screen compensation correction function which will take about 30 seconds. The power indicator will flash white (3 seconds on, then 3 seconds off) during this operation.

Then the image residue elimination function will run which will take about 10 minutes. During this operation the power indicator will flash white (1 second on and 1 second off).

When complete, the power indicator will turn orange for standby mode, or will be off for switch-off state.

During the maintaining, if the user presses the power button to turn the monitor on, the maintaining process will be interrupted and the display will take extra about 5 seconds to turn on.

You may check the number of time the image residue elimination function has run under the “Extra” section of the OSD menu.

- **Auto Warning**

If turn off Auto Warning and do not run Pixel Refresh or Panel Refresh within the recommended period, it may cause image retention issue on the display.

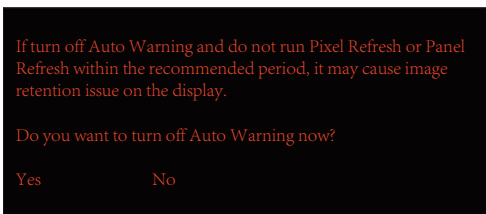

When the cumulative usage time reaches 16 hours, countdown warnings will start to appear 10 minutes before. (from 10 minutes to 1 minute remaining).

it is reminding you that the Monitor will go into maintaining process ,strongly suggest you save the files.

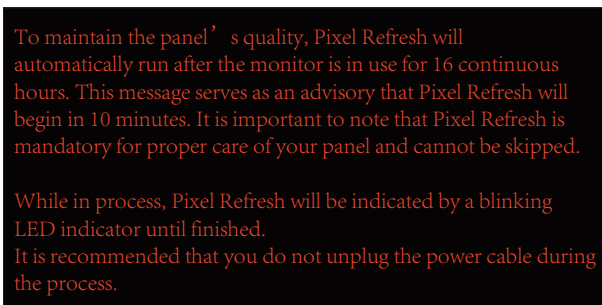

The following features have the default setting of “Off”, however they can be used to further protect your monitor against QD-OLED burn-in. It is recommended that you turn on these functions to further protect your panel:

- **Logos Protection**

The Multi-logo protection feature will dim the screen brightness if static logos are detected.

- **Boundary Dimmer**

The Boundary Dimmer feature will dim the brightness levels of detected areas that have a great change in brightness.

- **Taskbar Dimmer**

The Taskbar Dimmer feature will dim the brightness of the taskbar area.

- **ThermalProtection**

The Thermal Protection feature will keep the monitor's temperature under 60 degrees by reducing brightness levels.

Adjusting

Hotkeys

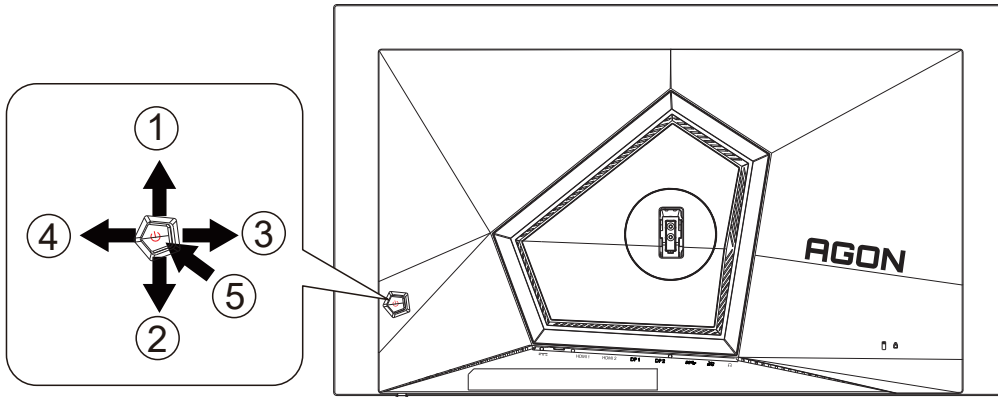

1	Source/Up
2	Dial Point/Down
3	Game Mode/Left
4	Light FX /Right
5	Power/ Menu/Enter

Power/Menu/Enter

Press the Power button to turn on the monitor.

When there is no OSD, Press to display the OSD or confirm the selection. Press about 2 seconds to turn off the monitor.

Dial Point/Down

When there is no OSD, press Dial Point button to show / hide Dial Point.

Game Mode/Left

When there is no OSD, press "Left" key to open game mode function, then press "Left" or "Right" key to select game mode (FPS, RTS, Racing, Gamer 1, Gamer 2 or Gamer 3) basing on the different game types.

Light FX/Right

When there is no OSD, press "Right" key to active Light FX function.

Source/Up

When the OSD is closed, press Source/Auto/Up button will be Source hot key function.

OSD Key Guide (Menu)



Enter : Use Enter key to enter the next OSD level
Move : Use Left / Up / Down key to move OSD selection
Exit : Use Right key to exit OSD



Enter : Use Enter key to enter the next OSD level
Move : Use Right / Up / Down key to move OSD selection
Exit : Use Left key to exit OSD



Enter : Use Enter key to enter the next OSD level
Move : Use Up / Down key to move OSD selection
Exit : Use Left key to exit OSD

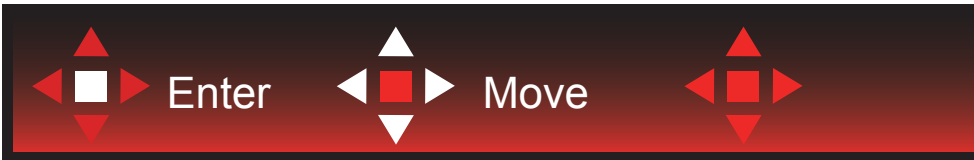

Move : Use Left / Right / Up / Down Key to move OSD selection



Exit : Use Left key to exit OSD to previous OSD level
Enter : Use Right key to enter next OSD level
Select : Use Up / Down key to move OSD selection



Enter : Use Enter key to apply the OSD setting and back to previous OSD level
Select : Use Down key to adjust OSD setting



Select : Use Up / Down key to adjust OSD setting



Enter : Use Enter key to exit OSD to previous OSD level
Select : Use Left / Right key to adjust OSD setting

OSD Setting

Basic and simple instruction on the control keys.

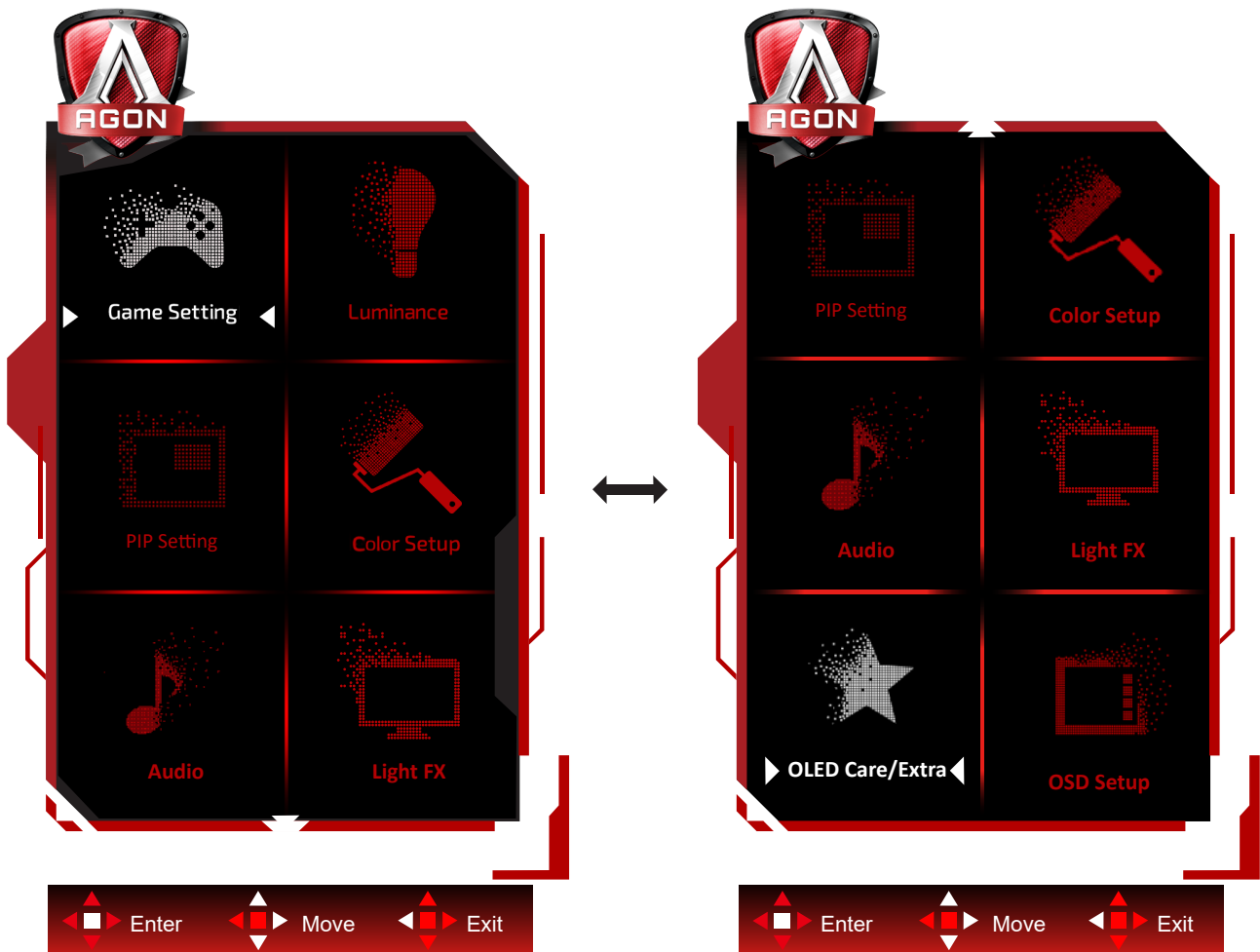

- 1). Press the MENU-button to activate the OSD window.
- 2). Follow Key Guide to move or select (adjust) OSD settings
- 3). OSD Lock/Unlock Function: To lock or unlock the OSD, press and hold the Down-button for 10s while OSD function is not active.

Notes:

- 1). If the product has only one signal input, the item of "Input Select" is disable to adjust.
- 2). ECO modes (except Standard mode), DCR and DCB mode, for these three states that only one state can exist.

Game Setting



	Game Mode	Off	No optimization by Game Mode.
		FPS	For playing FPS (First Person Shooters) games. Improves dark theme black level details.
		RTS	For playing RTS (Real Time Strategy). Improves the image quality.
		Racing	For playing Racing games, Provides fastest response time and high color saturation.
		Gamer 1	User's preference settings saved as Gamer 1.
		Gamer 2	User's preference settings saved as Gamer 2.
		Gamer 3	User's preference settings saved as Gamer 3.
	Shadow Control	0-100	Shadow Control Default is 50, then end-user can adjust from 50 to 100 or 0 to increase contrast for clear picture. 1. If picture is too dark to be saw the detail clearly, adjusting from 50 to 100 for clear picture. 2. If picture is too white to be saw the detail clearly, adjusting from 50 to 0 for clear picture
	Game Color	0-20	Game Color will provide 0-20 level for adjusting saturation to get better picture.
	Sniper Scope	Off /1.0 /1.5 /2.0	Zoom in locally to make it easier to target when shooting.
Adaptive-Sync	On / Off	Disable or Enable Adaptive-Sync.	

	Low Input lag	On / Off	Shutting down the frame buffer can reduce input delay. Note: Low input delay is disabled by default and unadjustable when the field frequency is less than 120 Hz; and it is enabled by default and unadjustable when the field frequency is equal to 120 Hz and in the G-SYNC state.
	Frame Counter	Off / Right-Up / Right-Down / Left-Down / Left-Up	Display V frequency on the corner selected (Frame counter feature only works with AMD graphic card.)

Note:







“Luminance” controls “Game Mode,” “Shadow Control,” and “Game Color” can only be adjusted when “HDR Mode” and “HDR” are set to “OFF.”

When the Color Space under Color Settings is set to sRGB or DCI-P3, the Game Mode, Dark Field Control, and Game Tone items are not adjustable.

Luminance



Luminance

	Contrast	50
	Brightness	70
	Dark Boost	Off
	ECO Mode	Standard
	Gamma	Gamma1
	HDR	Off

 Exit  Enter  Select

	Contrast	0-100	Contrast from Digital-register.	
	Brightness	0-100	Backlight Adjustment	
	Dark Boost	Off		
		Level 1		
		Level 2		
		Level 3		
	Eco mode	Standard		Standard Mode
		Text		Text Mode
		Internet		Internet Mode
		Game		Game Mode
		Movie		Movie Mode
		Sports		Sports Mode
		Reading		Reading Mode
	Gamma	Gamma1		Adjust to Gamma 1
		Gamma2		Adjust to Gamma 2
		Gamma3		Adjust to Gamma 3
	HDR	Off		Set the HDR profile according to your usage requirements. Note: When HDR is detected, the HDR option is displayed for adjustment.
		DisplayHDR		
		HDR 1000 Max		
		HDR Picture		
		HDR Movie		
HDR Game				
HDR Mode	Off		Optimized for the color and contrast of the picture, which will simulate showing the HDR effect. Note: When HDR is not detected, the HDR Mode option is displayed for adjustment.	
	HDR Picture			
	HDR Movie			
	HDR Game			

Note:

“Luminance” controls “Contrast,” “Eco Mode,” and “Gamma” can only be adjusted when “HDR Mode” is set to “OFF.”

No “Luminance” controls are adjustable when “HDR” is active.

When the Color Space under Color Settings is set to sRGB or DCI-P3, the Contrast, Brightness Scenario Mode, Gamma, and HDR/HDR Mode items are not adjustable.

PIP Setting

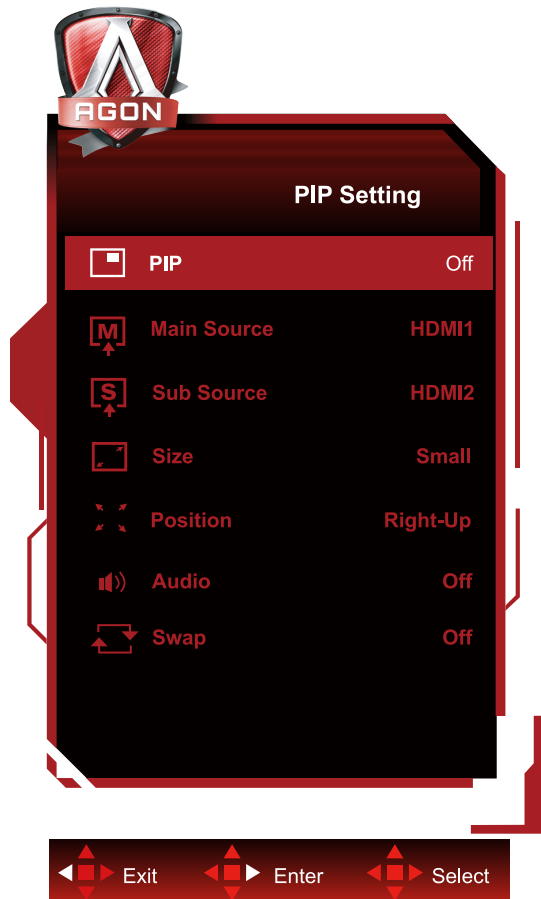

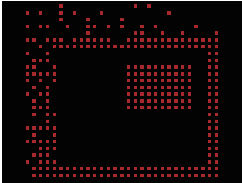
	PIP Setting	Off / PIP / PBP	Disable or Enable PIP or PBP.	
	Main Source		Select main screen source.	
	Sub Source		Select sub screen source.	
	Size	Small / Middle / Large	Select screen size.	
	Position	Right-up		Set the screen location.
		Right-down		
		Left-up		
		Left-down		
	Audio	On: PIP Audio		Disable or Enable Audio Setup.
		Off: Main Audio		
Swap	On: Swap		Swap the screen source.	
	Off: non action			

Note:

- 1) No “PIP Setting” under “Brightness” controls are adjustable when “HDR” is active.
- 2) When PIP/PBP is enabled, some color-related adjustments in the OSD menu are valid only for the main screen, while the sub-screen is not supported. Hence, the main screen and the sub-screen may have different colors.
- 3) Set the input signal resolution to 1280X1440@60Hz at PBP to achieve the desired display effect.
- 4) When PBP/PIP is enabled, the compatibility of the main screen/sub-screen input source is shown in the following table:

PBP/PIP		Main source			
		HDMI1	HDMI2	DP1	DP2
Sub source	HDMI1	V	V	V	V
	HDMI2	V	V	V	V
	DP1	V	V	V	V
	DP2	V	V	V	V

Color Setup

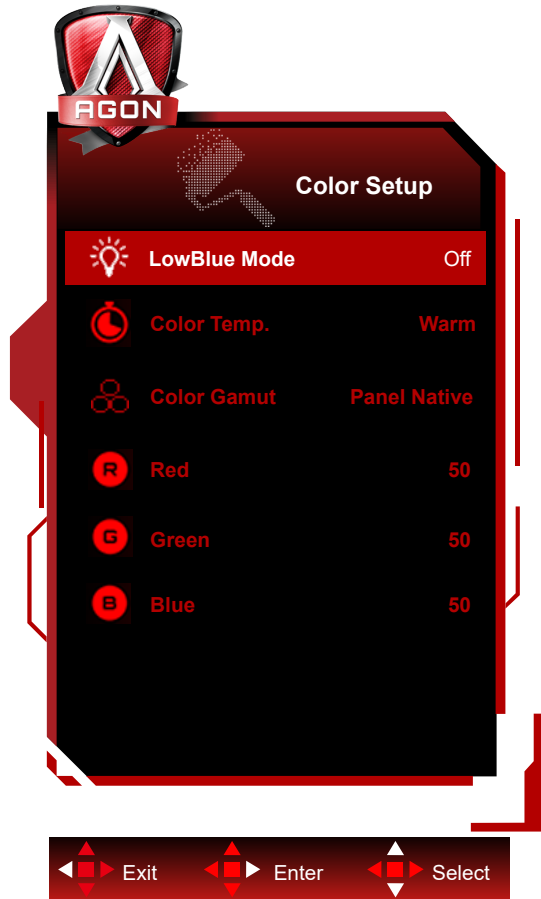

	LowBlue Mode	Off / Multimedia / Internet / Office / Reading	Decrease blue light wave by controlling color temperature.
	Color Temp.	Warm	Recall Warm Color Temperature from EEPROM.
		Normal	Recall Normal Color Temperature from EEPROM.
		Cool	Recall Cool Color Temperature from EEPROM.
		User	Restore user color temperature from EEPROM.
	Color Gamut	Panel Native	Standard color space panel.
		sRGB	Recall sRGB Color Temperature from EEPROM.
		DCI-P3	DCI-P3 color space.
	Red	0-100	Red gain from Digital-register.
Green	0-100	Green gain from Digital-register.	
Blue	0-100	Blue gain from Digital-register.	

Note:

“Luminance” controls under “Color Setup” can only be adjusted when “HDR Mode” or “HDR” is set to “OFF.” When Color Space is set to sRGB or DCI-P3, all other items under Color Settings cannot be adjusted.

Audio

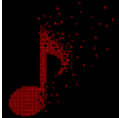

	Volume	0-100	Adjust volume setting
---	--------	-------	-----------------------

Light FX

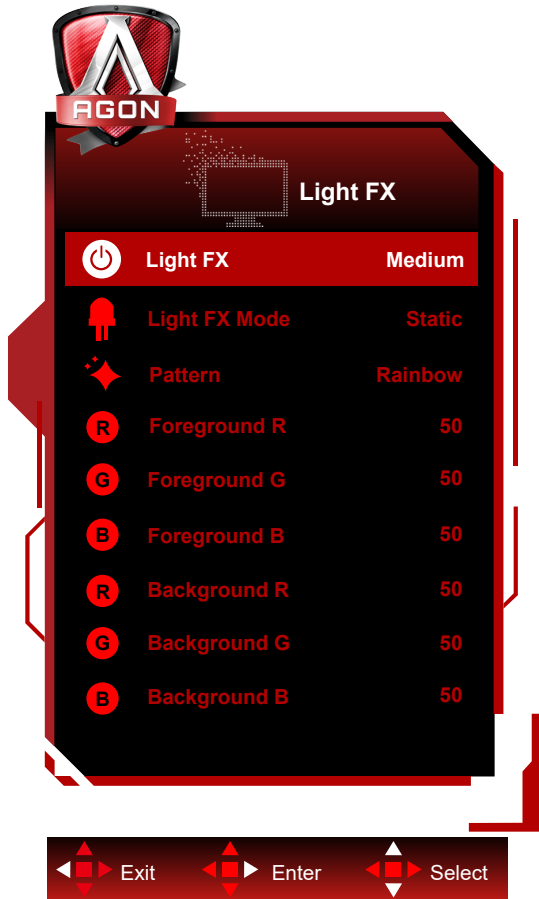

	Light FX	Off / Low / Medium / Strong	Select the intensity of Light FX.
	Light FX Mode	Audio1 / Audio2 / Static / Dark Point Sweep / Gradient Shift / Spread Fill / Drip Fill / Spreading Drip Fill / Breathing / Light Point Sweep / Zoom / Rainbow / Wave / Flashing / Demo	Select Light FX Mode
	Pattern	Red / Green / Blue / Rainbow / User Define	Select Light FX Pattern
	Foreground R	0-100	User can adjust Light FX foreground color, when Pattern setting to user define
	Foreground G		
	Foreground B		
	Background R	0-100	User can adjust Light FX background color, when Pattern setting to user define
	Background G		
Background B			

Extra

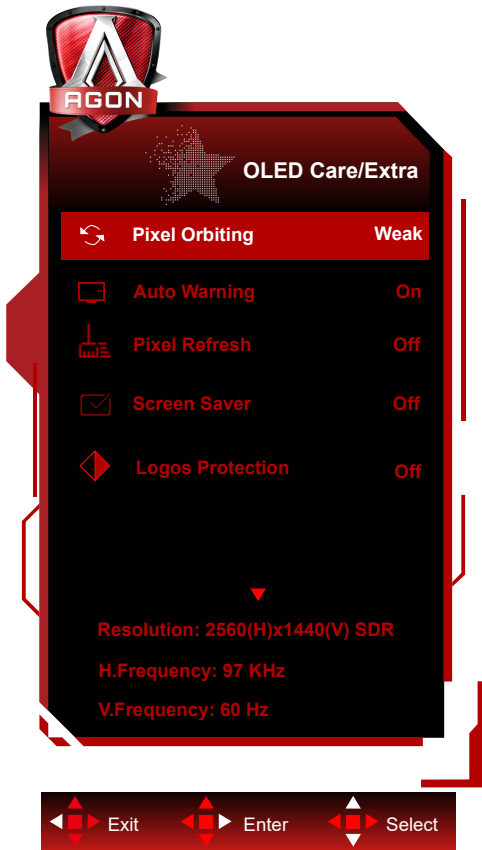

	Pixel Orbiting	Off / Weak / Medium / Strong	<p>Orbit will slightly shift the displayed image at the pixel level, once a second to prevent image retention.</p> <p>This function is "On (Weak)" by default, "Weak" moves the least, "Strong" moves the most, "Off" disables the movement and increases the chance of image retention. This can be set in the OSD menu.</p>
	Auto Warning	On/ Off	<p>Enable/Disable the "Pixel Refresh" Auto Warning feature.</p> <p>The monitor will automatically display an "Auto Warning" every 4 hours of cumulative usage to remind the user to run the "Pixel Refresh" process.</p> <p>Select "Off" to stop the Auto Warning for "Pixel Refresh." However, if the recommended time for running the "Pixel Refresh" is not followed, it may increase the risk of image retention on the screen. Please proceed with caution.</p>
	Pixel Refresh	On/ Off	<p>This function will help eliminate image retention.</p> <p>After startup, select "Yes" from the menu prompt. The display will shutdown the screen and run the maintenance cycle. The power indicator will flash white (1 second on/1 second off) while the cycle runs, about 10 minutes. At the end of the cycle the power indicator will turn off and the display will be in standby state.</p>

Screen Saver	Off / Slow / Fast	When a static image is detected for a certain period of time, the screen saver function will dim the screen to protect the panel from sticking. When a moving image is detected, the monitor will recover luminance to previous working status. Default setting is Slow and may change as Fast to active Screen Saver sooner. Would highly recommend that you always turn on Screen Saver as Slow or Fast to protect the screen. It is also recommended that you also set your device to use a screen saver.
Logos Protection	Off/1/2	When there are multiple static logos detected on the screen, it's suggested to turn on logos Protection; which will dim the screen to protect the panel from image sticking where logos are detected.
Boundary Dimmer	Off/1/2/3	For special aspect ratios that have a black area in the frame of the screen or a split-screen, the boundary dimmer feature can automatically detect and dim the brightness of specific areas with a large difference in brightness levels.
Taskbar Dimmer	Off/1/2/3	The Taskbar Dimmer technology will dim the brightness of the taskbar area on the screen. No brightness changes will be noticeable in the areas other than in the taskbar.
ThermalProtection	Off / On	When the temperature of the monitor is over 60 degrees Celsius, the Thermal Protection feature will automatically dim the brightness of the screen in order to ensure heat dissipation properly. It is recommended that you turn on the feature for the monitor.
Input Select	Auto/ HDMI1/ HDMI2/ DP1/ DP2	Select Input Signal Source
USB	Off / On	Enable/disable the USB function.
Off Timer	0-24hrs	Select DC off time
Image Ratio	Wide /Aspect / 4:3 /1:1 /17"(4:3) / 19"(4:3) / 19"(5:4) / 19"W(16:10) / 21.5"W(16:9) / 22"W(16:10) / 23"W(16:9) / 23.6"W(16:9) /24"W(16:9) /	Select image ratio for display.
DDC/CI	Yes or No	Turn On/Off DDC/CI Support
Reset	Yes or No	Reset the menu to default

OSD Setup

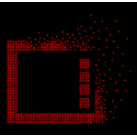

	Language		Select the OSD language
	Timeout	5-120	Adjust the OSD Timeout
	DP Capability	1.1/1.2/1.4	Note: Only DP1.2/DP1.4 support G-SYNC functionality.
	H. Position	0-100	Adjust the horizontal position of OSD
	V. Position	0-100	Adjust the vertical position of OSD
	Transparence	0-100	Adjust the transparence of OSD
	Break Reminder	On /Off	Enable a reminder for the user to take a break every hour of continuous activity, to prevent repetitive stress injury.

LED Indicator

Status	LED Color
Full Power Mode	White
Active-off Mode	Orange
Pixel Refresh under process	Flashing White (1 second on/1 second off)
JB under process	Flashing White (3 seconds on/3 seconds off)
OLED panel malfunction	Flashing Orange (1 second on/1 second off)
Shutdown mode	The indicator is not lit.

Troubleshooting

Problem	Possible solutions
The power indicator is not lit.	<ul style="list-style-type: none"> • Check if the power is turned on. • Check if the power cord is connected.
The power indicator is lit, but there is no image displayed.	<ul style="list-style-type: none"> • Check if the computer is powered on. • Use the Caps Lock key indicator to determine if the computer is responsive. • Check if the graphics card is properly seated and powered. • Check that the video cable is correctly connected between computer and display. • Check that the video cable plugs do not have bent pins.
There is no image, but the power indicator flashes orange.	<ul style="list-style-type: none"> • The OLED display is malfunctioning. Please contact AOC support for service.
Failure to Plug-and-Play.	<ul style="list-style-type: none"> • Check if the computer supports Plug-and-Play. • Check if the video adapter supports Plug-and-Play.
Dim image.	<ul style="list-style-type: none"> • Adjust luminance and contrast ratio.
The image is bouncing or rippled.	<ul style="list-style-type: none"> • There may be electrical interference occurring from nearby appliances or devices. Move the computer and monitor away from the interfering devices to resolve the problem.
The screen displays “the signal wire is not available” or “no signal.”	<ul style="list-style-type: none"> • Unplug and plug in the video cable. • Inspect the video cable pins for damage.
The screen displays “invalid input”.	<ul style="list-style-type: none"> • Reset the computer output to a display mode compatible with the display.
Image retention.	<ul style="list-style-type: none"> • Use the Pixel Refresh function to eliminate image retention from the screen. Refer to the “Screen Maintenance” section.
Regulation & Service	<p>Please refer to Regulation & Service Information which is in the CD manual or www.aoc.com (to find the model you purchase in your country and to find Regulation & Service Information in Support page.</p>

Specification

General Specification

Panel	Model Name	AG276QZD2		
	Driving System	OLED		
	Viewable Image Size	67.3 cm Diagonal		
	Pixel Pitch	0.2292mm(H) x 0.2292mm(V)		
	Display Color	1.07B Colors		
Others	Horizontal Scan Range	30k~360kHz(DP) 30k~230kHz(HDMI)		
	Horizontal scan Size(Maximum)	590.42 mm		
	Vertical Scan Range	48~144Hz (HDMI) 48~240Hz (DP)		
	Vertical Scan Size(Maximum)	333.72 mm		
	Optimal Preset Resolution	2560 x 1440@60Hz		
	Max Resolution	2560 x 1440@144Hz (HDMI) 2560 x 1440@240Hz (DP)		
	Plug & Play	VESA DDC2B/CI		
	Connector	HDMIx2/DPx2/USBx2/USB upstream/Earphone		
	Power Source	19.5V \equiv 6.93A		
	Power Consumption	Typical(Default Brightness And Contrast)	65 W	
		Max. (Brightness = 100, Contrast =100)	\leq 110 W	
Standby Mode		\leq 0.5 W		
Environmental	Temperature	Operating	0°C~ 40°C	
		Non-Operating	-25°C~ 55°C	
		Perform JB Function to Recommend Temperature	0°C~ 40°C	
	Humidity	Operating	10% ~ 85% (Non-Condensing)	
		Non-Operating	5% ~ 93% (Non-Condensing)	
	Altitude	Operating	0m~ 5000m (0ft~ 16404ft)	
Non-Operating		0m~ 12192m (0ft~ 40000ft)		

Note:

1)The maximum number of display colors supported by this product is 1.07 billion, and the setting conditions are as follows (there may be differences due to the output limitation of some graphics cards):

	HDMI2.0		DisplayPort1.4	
	YCbCr422 YCbCr420	YCbCr444 RGB	YCbCr422 YCbCr420	YCbCr444 RGB
2560x1440 240Hz 10bits	NA	NA	OK	OK
2560x1440 240Hz 8bits	NA	NA	OK	OK
2560x1440 200Hz 10bits	NA	NA	OK	OK
2560x1440 200Hz 8bits	NA	NA	OK	OK
2560x1440 165Hz 10bits	NA	NA	OK	OK
2560x1440 165Hz 8bits	NA	NA	OK	OK
2560x1440 144Hz 10bits	OK	NA	OK	OK
2560x1440 144Hz 8bits	OK	OK	OK	OK
2560x1440 120Hz 10bits	OK	NA	OK	OK
2560x1440 120Hz 8bits	OK	OK	OK	OK
2560x1440 60Hz 10bits	OK	OK	OK	OK
2560x1440 60Hz 8bits	OK	OK	OK	OK
Low resolution 10bpc	OK	OK	OK	OK
Low resolution 8bpc	OK	OK	OK	OK

2) In order to reach QHD 240Hz 1.07 billion colors (in RGB/YCbCr 4:4:4 format) for DP 1.4 (HBR3) signal input, a DSC-enabled graphics card must be used. Consult the graphics card manufacturer for DSC support.

Preset Display Modes

STANDARD	RESOLUTION ($\pm 1\text{Hz}$)	HORIZONTAL FREQUENCY(kHz)	VERTICAL FREQUENCY(Hz)
Signal Version Color Format State Color Bit VGA	640x480@60Hz	31.469	59.940
	640x480@72Hz	37.861	72.809
	640x480@75Hz	37.500	75.000
	640x480@100Hz	51.080	99.769
	640x480@120Hz	60.938	119.720
SVGA	800x600@56Hz	35.156	56.250
	800x600@60Hz	37.879	60.317
	800x600@72Hz	48.077	72.188
	800x600@75Hz	46.875	75.000
	800x600@100Hz	62.760	99.778
	800x600@120Hz	76.302	119.972
XGA	1024x768@60Hz	48.363	60.004
	1024x768@70Hz	56.476	70.069
	1024x768@75Hz	60.023	75.029
	1024x768@100Hz	80.450	99.811
	1024x768@120Hz	97.550	119.989
SXGA	1280x1024@60Hz	63.981	60.020
	1280x1024@75Hz	79.976	75.025
FHD	1920x1080@60Hz	67.500	60.000
	1920x1080@100Hz	112.500	100.000
	1920x1080@120Hz	137.260	119.982
	1920x1080@240Hz	278.400	240.000
QHD	2560x1440@60Hz	96.180	60.000
	2560x1440@120Hz	192.360	120.000
	2560x1440@144Hz	222.056	143.912
	2560x1440@165Hz	242.543	164.995
	2560x1440@240Hz	384.722	240.001
PBP	1280x1440@60Hz	89.450	59.913
	1280x1440@75Hz	111.972	74.998
	1280x1440@100Hz	149.300	100.000
	1280x1440@120Hz	179.157	119.998
	1280x1440@144Hz	214.994	144.002
	1280x1440@240Hz	358.320	240.000
IBM MODES			
DOS	720x400@70Hz	31.469	70.087
MAC MODES			
VGA	640x480@67Hz	35.000	66.667
SVGA	832x624@75Hz	49.725	74.551

Note: According to the VESA standard, different operating systems and graphics cards may have certain errors (+/-1Hz) on resolution. Actual please refer to the actual product.

Pin Assignments



19-Pin Color Display Signal Cable

Pin No.	Signal Name	Pin No.	Signal Name	Pin No.	Signal Name
1.	TMDS Data 2+	9.	TMDS Data 0-	17.	DDC/CEC Ground
2.	TMDS Data 2 Shield	10.	TMDS Clock +	18.	+5V Power
3.	TMDS Data 2-	11.	TMDS Clock Shield	19.	Hot Plug Detect
4.	TMDS Data 1+	12.	TMDS Clock-		
5.	TMDS Data 1Shield	13.	CEC		
6.	TMDS Data 1-	14.	Reserved (N.C. on device)		
7.	TMDS Data 0+	15.	SCL		
8.	TMDS Data 0 Shield	16.	SDA		

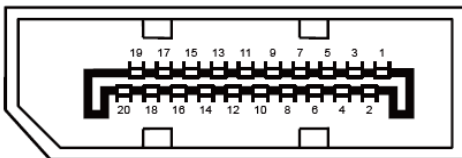

20-Pin Color Display Signal Cable

Pin No.	Signal Name	Pin No.	Signal Name
1	ML_Lane 3 (n)	11	GND
2	GND	12	ML_Lane 0 (p)
3	ML_Lane 3 (p)	13	CONFIG1
4	ML_Lane 2 (n)	14	CONFIG2
5	GND	15	AUX_CH(p)
6	ML_Lane 2 (p)	16	GND
7	ML_Lane 1 (n)	17	AUX_CH(n)
8	GND	18	Hot Plug Detect
9	ML_Lane 1 (p)	19	Return DP_PWR
10	ML_Lane 0 (n)	20	DP_PWR

Plug and Play

Plug & Play DDC2B Feature

This monitor is equipped with VESA DDC2B capabilities according to the VESA DDC STANDARD. It allows the monitor to inform the host system of its identity and, depending on the level of DDC used, communicate additional information about its display capabilities.

The DDC2B is a bi-directional data channel based on the I2C protocol. The host can request EDID information over the DDC2B channel.



For DTS patents, see <http://patents.dts.com>. Manufactured under license from DTS Licensing Limited. DTS, the Symbol, & DTS and the Symbol together are registered trademarks, and DTS Sound is a trademark of DTS, Inc. © DTS, Inc. All Rights Reserved.