

TOSHIBA
Leading Innovation >>>

User's Manual

Satellite Pro R50-E/A50-E
TECRA A50-E/Z50-E

Table of Contents

<i>Chapter 1</i>	TOSHIBA Legal, Regulatory, and Safety	
	Copyright, Disclaimer and Trademarks	1-1
	Regulatory Information	1-2
	Video Standard Notice	1-10
	OpenSSL Toolkit License Issues	1-10
	FreeType License Issues	1-12
	ENERGY STAR® Program	1-16
	Disposing of the computer and the computer's batteries	1-16
	Optical disc drive safety instructions	1-17
	General Precautions	1-18
	Safety Icons	1-21
<i>Chapter 2</i>	Getting Started	
	Equipment checklist	2-1
	Conventions	2-1
	Using your computer for the first time	2-2
	Getting to know Windows	2-6
	Turning off the power	2-8
	System Recovery	2-12
<i>Chapter 3</i>	The Grand Tour	
	Front with the display closed	3-1
	Left side	3-2
	Right side	3-4
	Back	3-6
	Underside	3-6
	Front with the display open	3-8
	Internal Hardware Components	3-12
	Power Condition Descriptions	3-13
<i>Chapter 4</i>	Operating Basics	
	Using the Touch Pad	4-1
	The Keyboard	4-2
	Optical disc drive	4-5
	CyberLink PowerDVD 14 DVD for TOSHIBA	4-10
	Using the AccuPoint	4-12
	Using the Fingerprint Sensor	4-13
	Battery	4-15

Wireless WAN Device	4-21
GPS Function	4-23
Additional memory module	4-23
LAN	4-28
Memory media	4-30
Smart Card	4-33
External Display	4-34
TOSHIBA Hi-Speed Port Replicator III 180W/120W	4-37
Security lock	4-39
Optional TOSHIBA Accessories	4-39
Sound System and Video mode	4-40

Chapter 5

Utilities and Advanced Usage

Utilities and Applications	5-1
Special features	5-8

Chapter 6

Troubleshooting

Problem-solving process	6-1
Hardware and system checklist	6-4
TOSHIBA support	6-16

Chapter 7

Appendix

Specifications	7-1
AC Power Cord and Connectors	7-2
Information for Wireless Devices	7-4
Information about Intel® AMT	7-15
Information about Intel® Authenticate	7-18
Legal Footnotes	7-18

Index

Chapter 1

TOSHIBA Legal, Regulatory, and Safety

This chapter states the legal, regulatory, and safety information applicable to TOSHIBA computers.



TOSHIBA means Toshiba Corporation and/or its affiliates such as Toshiba Client Solutions Co., Ltd. where applicable.

Copyright, Disclaimer and Trademarks

Copyright

© 2017 Toshiba Client Solutions Co., Ltd. All Rights Reserved. Under the copyright laws, this manual cannot be reproduced in any form without the prior written permission of TOSHIBA. No patent liability is assumed, with respect to the use of the information contained herein.

First edition November 2017

Copyright authority for music, movies, computer programs, databases and other intellectual property covered by copyright laws belongs to the author or to the copyright owner. Copyrighted material can be reproduced only for personal use or use within the home. Any other use beyond that stipulated above (including conversion to digital format, alteration, transfer of copied material and distribution on a network) without the permission of the copyright owner is a violation of copyright or author's rights and is subject to civil damages or criminal action. Comply with copyright laws in making any reproduction from this manual.

Disclaimer

This manual has been validated and reviewed for accuracy. The instructions and descriptions it contains are accurate for your computer at the time of this manual's production. However, succeeding computers and manuals are subject to change without notice. TOSHIBA assumes no liability for damages incurred directly or indirectly from errors, omissions or discrepancies between the computer and the manual.

Trademarks

Intel, Intel logo are trademark of Intel Corporation or its subsidiaries in the United States and/or other countries.

Microsoft, Windows are either registered trademarks or trademarks of Microsoft Corporation in the United States and/or other countries.

The Bluetooth® word mark is a registered trademark owned by Bluetooth SIG, Inc.

The terms HDMI and HDMI High-Definition Multimedia Interface, and the HDMI Logo are registered trademarks or trademarks of HDMI Licensing LLC in the United States and other countries.

DTS, the Symbol, & DTS and the Symbol together are registered trademarks and DTS Studio Sound is a trademark of DTS, Inc.

Wi-Fi is a registered trademark of Wi-Fi Alliance.

USB Type-C™ is a trademark of USB Implementers Forum.

All other company names, product names, and service names mentioned herein may be trademarks of their respective companies.

Regulatory Information



The regulatory information herein might vary. Check the ID information on the bottom of the device for specific information applicable to the model you purchased.

FCC information

FCC notice "Declaration of Conformity Information"

This equipment has been tested and found to comply with the limits for a Class B digital device, pursuant to part 15 of the FCC rules. These limits are designed to provide reasonable protection against harmful interference in a residential installation. This equipment generates, uses and can radiate radio frequency energy and, if not installed and used in accordance with the instructions, may cause harmful interference to radio communications. However, there is no guarantee that interference will not occur in a particular installation. If this equipment does cause harmful interference to radio or television reception, which can be determined by turning the equipment off and on, the user is encouraged to try to correct the interference by one or more of the following measures:

- Reorient or relocate the receiving antenna.
- Increase the separation between the equipment and receiver.
- Connect the equipment into an outlet on a circuit different from that to which the receiver is connected.
- Consult the dealer or an experienced radio/TV technician for help.



Only peripherals complying with the FCC class B limits can be attached to this equipment. Operation with non-compliant peripherals or peripherals not recommended by TOSHIBA is likely to result in interference to radio and

TV reception. Shielded cables must be used between the external devices and the computer's external RGB monitor port, Universal Serial Bus (USB 2.0 and 3.0) ports, HDMI™ out port and Headphone/Microphone jack. Changes or modifications made to this equipment, not expressly approved by TOSHIBA or parties authorized by TOSHIBA could void the user's authority to operate the equipment.

FCC conditions

This device complies with part 15 of the FCC Rules. Operation is subject to the following two conditions:

1. This device may not cause harmful interference.
2. This device must accept any interference received, including interference that may cause undesired operation.

Contact

Address: Toshiba America Information Systems Inc.
5241 California Avenue, Suite 100
Irvine, California, USA, 92617

Telephone: (949) 583-3000



This information is only applicable for the countries/regions where it is required.

California Prop 65 Warning



This product contains chemicals, including lead, known to the State of California to cause cancer and birth defects or other reproductive harm.
Wash hands after handling.



For the state of California only.

Export Administration Regulation

This document contains technical data that may be controlled under the U.S. Export Administration Regulations, and may be subject to the approval of the U.S. Department of Commerce prior to export. Any export, directly or indirectly, in contravention of the U.S. Export Administration Regulations is prohibited.

EU Declaration of Conformity



This product is carrying the CE-Mark in accordance with the related European Directives. Responsible for CE-Marking is TOSHIBA EUROPE GMBH, Hammfelddamm 8, 41460 Neuss, Germany. The complete and official EU Declaration of Conformity can be found on TOSHIBA's web site <http://epps.toshiba-teg.com> on the Internet.

CE compliance

Hereby, Toshiba Europe GmbH declares that the model(s) described in this manual is/are in compliance with Directive 2014/53/EU.

The full text of the EU declaration of conformity is available at the following internet address:

<https://epps.toshiba-teg.com/>

This product is labeled with the CE Mark in accordance with the essential requirements and other relevant provisions of the applicable European Directives, notably Radio Equipment Directive (2014/53/EU), RoHS Directive 2011/65/EU, Ecodesign Directive 2009/125/EC (ErP) and the related implementing measures.

This product and the original options are designed to observe the applicable EMC (Electromagnetic Compatibility) standards. However, TOSHIBA cannot guarantee that this product still observes these EMC standards if options or cables not produced by TOSHIBA are connected or implemented. In this case the persons who have connected/implemented those options/cables have to provide assurance that the system (PC plus options/cables) still fulfils the required standards. To avoid in general EMC problems, the following guidance should be noted:

- Only CE marked options should be connected/implemented
- Only best shielded cables should be connected

Working environment

This product was designed to fulfil the EMC (Electromagnetic Compatibility) requirements to be observed for so-called "Residential, commercial and light industry environments". TOSHIBA do not recommend the use of this product in working environments other than the above listed working environment.

For example, the following environments are not verified:

- Industrial Environments (e.g. environments where a mains voltage of 380 V three-phase is used)
- Medical Environments (according to Medical Device Directive)
- Automotive Environments

- Aircraft Environments

Any consequences resulting from the use of this product in working environments that are not verified/recommended are not the responsibility of TOSHIBA.

The consequences of the use of this product in non-verified working environments may be:

- Interference with other devices or machines in the near surrounding area.
- Malfunction of, or data loss from, this product caused by disturbances generated by other devices or machines in the near surrounding area.

Therefore TOSHIBA strongly recommend that the electromagnetic compatibility of this product should be suitably tested in all non-verified working environments before use. In the case of vehicles or aircraft, the manufacturer or airline operator respectively should be asked for permission before use of this product.

Furthermore, for general safety reasons, the use of this product in environments with explosive atmospheres is not permitted.

VCCI Class B Information (Japan Only)

この装置は、クラスB情報技術装置です。この装置は、家庭環境で使用することを目的としていますが、この装置がラジオやテレビジョン受信機に近接して使用されると、受信障害を引き起こすことがあります。取扱説明書に従って正しい取り扱いをしてください。

VCCI-B

Canadian regulatory information (Canada only)

This digital apparatus does not exceed the Class B limits for radio noise emissions from digital apparatus as set out in the Radio Interference Regulation of the Canadian Department of Communications.

Note that Canadian Department of Communications (DOC) regulations provide, that changes or modifications not expressly approved by TOSHIBA could void your authority to operate this equipment.

This Class B digital apparatus meets all requirements of the Canadian Interference-Causing Equipment Regulations.

Cet appareil numérique de la classe B respecte toutes les exigences du Règlement sur le matériel brouilleur du Canada.

Canadian Notice

This device complies with ISSED (formerly Industry Canada) license-exempt RSS standard(s).

Operation is subject to the following two conditions: (1) this device may not cause interference, and (2) this device must accept any interference, including interference that may cause undesired operation of the device.

Le présent appareil est conforme aux CNR d'Industrie Canada applicables aux appareils radio exempts de licence. L'exploitation est autorisée aux deux conditions suivantes : (1) l'appareil ne doit pas produire de brouillage, et (2) l'appareil doit accepter tout brouillage radioélectrique subi, même si le brouillage est susceptible d'en compromettre le fonctionnement.



- *To comply with the Canadian RF exposure compliance requirements, this device and its antenna must not be co-located or operating in conjunction with any other antenna or transmitter. When operating this computer, minimum distance of 13 mm from the antenna must be maintained.*

Pour être conforme aux exigences canadiennes en matière d'exposition aux fréquences radio, l'appareil et son antenne ne doivent pas être situés au même endroit qu'une autre antenne ou un autre émetteur ni fonctionner en même temps. Une distance minimale de 13 mm de l'antenne doit être maintenue durant l'utilisation de cet ordinateur.

- *This device is restricted to indoor use due to its operation in the 5.15 GHz to 5.25 GHz frequency range. FCC requires this product to be used indoors for frequency range 5.15 GHz to 5.25 GHz to reduce the potential for harmful interference to co-channel Mobile Satellite systems.*

High power radars are allocated as primary users of the 5.25 GHz to 5.35 GHz and 5.65 GHz to 5.85 GHz bands. These radar stations can cause interference with and/or damage this device.

Les dispositifs fonctionnant dans la bande 5150-5250 MHz sont réservés uniquement pour une utilisation à l'intérieur afin de réduire les risques de brouillage préjudiciable aux systèmes de satellites mobiles utilisant les mêmes canaux.

Veillez noter que les utilisateurs de radars de haute puissance sont désignés utilisateurs principaux (c.-à-d., qu'ils ont la priorité) pour les bandes 5250-5350 MHz et 5650-5850 MHz et que ces radars pourraient causer du brouillage et/ou des dommages aux dispositifs LAN-EL.



The above caution applies to products that operate with an 802.11a radio device.

La mise en garde ci-dessus ne s'applique qu'aux appareils ayant un transmetteur opérant en mode 802.11 a.

Following information is only valid for EU-member States:

Information requirements Regulation EC 1275/2008

Additional information as required by Regulation (EC) 1275/2008 amended by Regulation (EU) 801/2013 implementing European Eco-Design Directive with regard to requirements for standby, off mode and networked standby electric power consumption of electrical and electronic household and office equipment can be found here:

<http://www.toshiba.eu/Eco-Design>

Disposal of products



The crossed out wheeled dust bin symbol indicates that products must be collected and disposed of separately from household waste. Integrated batteries and accumulators can be disposed of with the product. They will be separated at the recycling centres.

The black bar indicates that the product was placed on the market after August 13, 2005.

By participating in the separate collection of products and batteries, you will help to assure the proper disposal of products and batteries and thus help to prevent potential negative consequences for the environment and human health.

For more detailed information about the collection and recycling programmes available in your country, please visit our website

(www.toshiba.eu/recycling) or contact your local council office or the retail outlet where you purchased the product.

Disposal of batteries and/or accumulators



Pb, Hg, Cd

The crossed out wheeled dust bin symbol indicates that batteries and/or accumulators must be collected and disposed of separately from household waste.

If the battery or accumulator contains more than the specified values of lead (Pb), mercury (Hg), and/or cadmium (Cd) defined in the European Battery Directive, then the chemical symbols for lead (Pb), mercury (Hg) and/or cadmium (Cd) will appear below the crossed out wheeled dust bin symbol.

By participating in the separate collection of batteries, you will help to assure the proper disposal of products and batteries and thus help to prevent potential negative consequences for the environment and human health. To achieve this you should take any battery and/or accumulator to your local recycling site, or to a retail outlet or facility that offers to collect these devices for environmentally friendly disposal, ensuring that the terminal contacts are covered by non-conductive tape.

For more detailed information about the collection and recycling programmes available in your country, please visit our website

(www.toshiba.eu/recycling) or contact your local council office or the retail outlet where you purchased the product.



These symbols might not stick depending on the country and region where you purchased.

REACH - Compliance Statement

The European Union (EU) chemical regulation, REACH (Registration, Evaluation, Authorization and Restriction of Chemicals), entered into force on 1 June 2007, with phased deadlines to 2018.

Toshiba will meet all REACH requirements and is committed to provide our customers with information about the presence in our articles of substances included on the candidate list according to REACH regulation.

Please consult the following website

www.toshiba.eu/reach for information about the presence in our articles of substances included on the candidate list according to REACH in a concentration above 0.1 % weight by weight.

Following information is only for Turkey:

- Disposal of products:



The crossed wheeled bin symbol means that this product should not be collected and disposed of with other household wastes. When product become waste at the end-of-life, to protect environment and human health, it should be given to nearest collection recycling or disposal center. For more information about collection and recycling programs in your country please contact your local authority or the retailer where the product was purchased.

- Toshiba meets all requirements of Turkish regulation 28300 "Restriction of the use of certain hazardous substances in electrical and electronic equipment".

AEEE Yönetmeliğine Uygundur

Toshiba 28300 sayılı Türkiye "Elektrikle çalışan ve elektronik ekipmanda belirli tehlikeli maddelerin kullanımıyla ilgili kısıtlama" yönetmeliği gereklerini tamamen yerine getirmektedir

- The number of possible pixel failures of your display is defined according to ISO 9241-307 standards. If the number of pixel failures is less than this standard, they will not be counted as defect or failure.
- Battery is a consumption product, since the battery time depends on the usage of your computer. If the battery can not be charged at all, then it is a defect or failure. The changes in battery time is not a defect or failure.

Following information is only for India:



The use of this symbol indicates that this product may not be treated as household waste.

By ensuring this product is disposed of correctly, you will help prevent potential negative consequences for the environment and human health, which could otherwise be caused by inappropriate waste handling of this product.

For more detailed information about recycling of this product, please visit our website

(<http://www.toshiba-india.com>) or contact call center (1800-200-6768).



These symbols might not stick depending on the country and region where you purchased.

Video Standard Notice

THIS PRODUCT IS LICENSED UNDER THE AVC, THE VC-1 AND MPEG-4 VISUAL PATENT PORTFOLIO LICENSE FOR THE PERSONAL AND NON-COMMERCIAL USE OF A CONSUMER FOR (I) ENCODING VIDEO IN COMPLIANCE WITH THE ABOVE STANDARDS ("VIDEO") AND/OR (II) DECODING AVC, VC-1 AND MPEG-4 VIDEO THAT WAS ENCODED BY A CONSUMER ENGAGED IN A PERSONAL AND NONCOMMERCIAL ACTIVITY AND/OR WAS OBTAINED FROM A VIDEO PROVIDER LICENSED BY MPEG LA TO PROVIDE SUCH VIDEO. NO LICENSE IS GRANTED OR SHALL BE IMPLIED FOR ANY OTHER USE. ADDITIONAL INFORMATION INCLUDING THAT RELATING TO PROMOTIONAL, INTERNAL AND COMMERCIAL USES AND LICENSING MAY BE OBTAINED FROM MPEG LA, L.L.C. SEE <http://www.mpegla.com>

OpenSSL Toolkit License Issues

LICENSE ISSUES

=====

The OpenSSL toolkit stays under a dual license, i.e. both the conditions of the OpenSSL License and the original SSLeay license apply to the toolkit. See below for the actual license texts. Actually both licenses are BSD-style Open Source licenses. In case of any license issues related to OpenSSL please contact openssl-core@openssl.org.

OpenSSL License

/*=====

Copyright (c) 1998-2011 The OpenSSL Project. All rights reserved.

Redistribution and use in source and binary forms, with or without modification, are permitted provided that the following conditions are met:

1. Redistributions of source code must retain the above copyright notice, this list of conditions and the following disclaimer.
2. Redistributions in binary form must reproduce the above copyright notice, this list of conditions and the following disclaimer in the documentation and/or other materials provided with the distribution.
3. All advertising materials mentioning features or use of this software must display the following acknowledgment:
"This product includes software developed by the OpenSSL Project for use in the OpenSSL Toolkit."
(<http://www.openssl.org/>)
4. The names "OpenSSL Toolkit" and "OpenSSL Project" must not be used to endorse or promote products derived from this software without prior written permission. For written permission, please contact openssl-core@openssl.org.

-
5. Products derived from this software may not be called "OpenSSL" nor may "OpenSSL" appear in their names without prior written permission of the OpenSSL Project.
 6. Redistributions of any form whatsoever must retain the following acknowledgment:

"This product includes software developed by the OpenSSL Project for use in the OpenSSL Toolkit"

(<http://www.openssl.org/>)

THIS SOFTWARE IS PROVIDED BY THE OpenSSL PROJECT ``AS IS'' AND ANY EXPRESSED OR IMPLIED WARRANTIES, INCLUDING, BUT NOT LIMITED TO, THE IMPLIED WARRANTIES OF MERCHANTABILITY AND FITNESS FOR A PARTICULAR PURPOSE ARE DISCLAIMED. IN NO EVENT SHALL THE OpenSSL PROJECT OR ITS CONTRIBUTORS BE LIABLE FOR ANY DIRECT, INDIRECT, INCIDENTAL, SPECIAL, EXEMPLARY, OR CONSEQUENTIAL DAMAGES (INCLUDING, BUT NOT LIMITED TO, PROCUREMENT OF SUBSTITUTE GOODS OR SERVICES; LOSS OF USE, DATA, OR PROFITS; OR BUSINESS INTERRUPTION) HOWEVER CAUSED AND ON ANY THEORY OF LIABILITY, WHETHER IN CONTRACT, STRICT LIABILITY, OR TORT (INCLUDING NEGLIGENCE OR OTHERWISE) ARISING IN ANY WAY OUT OF THE USE OF THIS SOFTWARE, EVEN IF ADVISED OF THE POSSIBILITY OF SUCH DAMAGE.

=====
This product includes cryptographic software written by Eric Young (eay@cryptsoft.com). This product includes software written by Tim Hudson (tjh@cryptsoft.com).

*/

Original SSLeay License

/* Copyright (C) 1995-1998 Eric Young (eay@cryptsoft.com)

All rights reserved.

This package is an SSL implementation written by Eric Young (eay@cryptsoft.com).

The implementation was written so as to conform with Netscapes SSL.

This library is free for commercial and non-commercial use as long as the following conditions are aheared to. The following conditions apply to all code found in this distribution, be it the RC4, RSA, lhash, DES, etc., code; not just the SSL code. The SSL documentation included with this distribution is covered by the same copyright terms except that the holder is Tim Hudson (tjh@cryptsoft.com).

Copyright remains Eric Young's, and as such any Copyright notices in the code are not to be removed.

If this package is used in a product, Eric Young should be given attribution as the author of the parts of the library used.

This can be in the form of a textual message at program startup or in documentation (online or textual) provided with the package.

Redistribution and use in source and binary forms, with or without modification, are permitted provided that the following conditions are met:

1. Redistributions of source code must retain the copyright notice, this list of conditions and the following disclaimer.
2. Redistributions in binary form must reproduce the above copyright notice, this list of conditions and the following disclaimer in the documentation and/or other materials provided with the distribution.
3. All advertising materials mentioning features or use of this software must display the following acknowledgement:

"This product includes cryptographic software written by Eric Young (eay@cryptsoft.com)"

The word 'cryptographic' can be left out if the routines from the library being used are not cryptographic related :-).

4. If you include any Windows specific code (or a derivative thereof) from the apps directory (application code) you must include an acknowledgement:

"This product includes software written by Tim Hudson (tjh@cryptsoft.com)"

THIS SOFTWARE IS PROVIDED BY ERIC YOUNG ``AS IS'' AND ANY EXPRESS OR IMPLIED WARRANTIES, INCLUDING, BUT NOT LIMITED TO, THE IMPLIED WARRANTIES OF MERCHANTABILITY AND FITNESS FOR A PARTICULAR PURPOSE ARE DISCLAIMED. IN NO EVENT SHALL THE AUTHOR OR CONTRIBUTORS BE LIABLE FOR ANY DIRECT, INDIRECT, INCIDENTAL, SPECIAL, EXEMPLARY, OR CONSEQUENTIAL DAMAGES (INCLUDING, BUT NOT LIMITED TO, PROCUREMENT OF SUBSTITUTE GOODS OR SERVICES; LOSS OF USE, DATA, OR PROFITS; OR BUSINESS INTERRUPTION) HOWEVER CAUSED AND ON ANY THEORY OF LIABILITY, WHETHER IN CONTRACT, STRICT LIABILITY, OR TORT (INCLUDING NEGLIGENCE OR OTHERWISE) ARISING IN ANY WAY OUT OF THE USE OF THIS SOFTWARE, EVEN IF ADVISED OF THE POSSIBILITY OF SUCH DAMAGE.

The licence and distribution terms for any publically available version or derivative of this code cannot be changed. i.e. this code cannot simply be copied and put under another distribution licence [including the GNU Public Licence.]

*/

FreeType License Issues

The FreeType Project LICENSE

2006-Jan-27

Copyright 1996-2002, 2006 by

David Turner, Robert Wilhelm, and Werner Lemberg

Introduction

=====

The FreeType Project is distributed in several archive packages; some of them may contain, in addition to the FreeType font engine, various tools and contributions which rely on, or relate to, the FreeType Project.

This license applies to all files found in such packages, and which do not fall under their own explicit license. The license affects thus the FreeType font engine, the test programs, documentation and makefiles, at the very least.

This license was inspired by the BSD, Artistic, and IJG (Independent JPEG Group) licenses, which all encourage inclusion and use of free software in commercial and freeware products alike. As a consequence, its main points are that:

- We don't promise that this software works. However, we will be interested in any kind of bug reports. ('as is' distribution)
- You can use this software for whatever you want, in parts or full form, without having to pay us. ('royalty-free' usage)
- You may not pretend that you wrote this software. If you use it, or only parts of it, in a program, you must acknowledge somewhere in your documentation that you have used the FreeType code. ('credits')

We specifically permit and encourage the inclusion of this software, with or without modifications, in commercial products.

We disclaim all warranties covering The FreeType Project and assume no liability related to The FreeType Project.

Finally, many people asked us for a preferred form for a credit/disclaimer to use in compliance with this license. We thus encourage you to use the following text:

""""

Portions of this software are copyright (C) <year> The FreeType Project
www.freetype.org

All rights reserved.

""""

Please replace <year> with the value from the FreeType version you actually use.

Legal Terms

=====

0. Definitions

Throughout this license, the terms 'package', 'FreeType Project', and 'FreeType archive' refer to the set of files originally distributed by the

authors (David Turner, Robert Wilhelm, and Werner Lemberg) as the 'FreeType Project', be they named as alpha, beta or final release.

'You' refers to the licensee, or person using the project, where 'using' is a generic term including compiling the project's source code as well as linking it to form a 'program' or 'executable'. This program is referred to as 'a program using the FreeType engine'.

This license applies to all files distributed in the original FreeType Project, including all source code, binaries and documentation, unless otherwise stated in the file in its original, unmodified form as distributed in the original archive. If you are unsure whether or not a particular file is covered by this license, you must contact us to verify this.

The FreeType Project is copyright (C) 1996-2000 by David Turner, Robert Wilhelm, and Werner Lemberg. All rights reserved except as specified below.

1. No Warranty

THE FREETYPE PROJECT IS PROVIDED 'AS IS' WITHOUT WARRANTY OF ANY KIND, EITHER EXPRESS OR IMPLIED, INCLUDING, BUT NOT LIMITED TO, WARRANTIES OF MERCHANTABILITY AND FITNESS FOR A PARTICULAR PURPOSE. IN NO EVENT WILL ANY OF THE AUTHORS OR COPYRIGHT HOLDERS BE LIABLE FOR ANY DAMAGES CAUSED BY THE USE OR THE INABILITY TO USE, OF THE FREETYPE PROJECT.

2. Redistribution

This license grants a worldwide, royalty-free, perpetual and irrevocable right and license to use, execute, perform, compile, display, copy, create derivative works of, distribute and sublicense the FreeType Project (in both source and object code forms) and derivative works thereof for any purpose; and to authorize others to exercise some or all of the rights granted herein, subject to the following conditions:

- Redistribution of source code must retain this license file ('FTL.TXT') unaltered; any additions, deletions or changes to the original files must be clearly indicated in accompanying documentation. The copyright notices of the unaltered, original files must be preserved in all copies of source files.
- Redistribution in binary form must provide a disclaimer that states that the software is based in part of the work of the FreeType Team, in the distribution documentation. We also encourage you to put an URL to the FreeType web page in your documentation, though this isn't mandatory.

These conditions apply to any software derived from or based on the FreeType Project, not just the unmodified files. If you use our work, you must acknowledge us. However, no fee need be paid to us.

3. Advertising

Neither the FreeType authors and contributors nor you shall use the name of the other for commercial, advertising, or promotional purposes without specific prior written permission.

We suggest, but do not require, that you use one or more of the following phrases to refer to this software in your documentation or advertising materials: `FreeType Project`, `FreeType Engine`, `FreeType library`, or `FreeType Distribution`.

As you have not signed this license, you are not required to accept it. However, as the FreeType Project is copyrighted material, only this license, or another one contracted with the authors, grants you the right to use, distribute, and modify it. Therefore, by using, distributing, or modifying the FreeType Project, you indicate that you understand and accept all the terms of this license.

4. Contacts

There are two mailing lists related to FreeType:

- freetype@nongnu.org
Discusses general use and applications of FreeType, as well as future and wanted additions to the library and distribution. If you are looking for support, start in this list if you haven't found anything to help you in the documentation.
- freetype-devel@nongnu.org
Discusses bugs, as well as engine internals, design issues, specific licenses, porting, etc.

Our home page can be found at

<http://www.freetype.org>

ENERGY STAR® Program



Your Computer model may be ENERGY STAR® compliant. If the model you purchased is compliant, it uses the ENERGY STAR logo and the following information applies.

TOSHIBA is a partner in the ENERGY STAR Program and has designed this computer to meet the latest ENERGY STAR guidelines for energy efficiency. Your computer ships with the power management options preset to a configuration that will provide the most stable operating environment and optimum system performance for both AC power and battery modes.

To conserve energy, your computer is set to enter the low-power Sleep Mode which shuts down the system and display within 15 minutes of inactivity in AC power mode.

TOSHIBA recommends that you leave this and other energy saving features active, so that your computer will operate at its maximum energy efficiency. You can wake the computer from Sleep Mode by pressing the power button.

Your ENERGY STAR certified computer should be set by default to enter a low-power "sleep mode" after a period of inactivity. Simply touching the mouse or keyboard "wakes" the computer in seconds. These sleep features can save you up to \$23 per year (200 kWh per year in electricity) and prevent up to 300 pounds of greenhouse gas emissions annually. To learn how to adjust or activate these sleep settings on your computer, please go to:

www.energystar.gov/sleepinstructions

To activate sleep settings organization-wide quickly and easily through network tools, please go to:

www.energystar.gov/powermanagement

Disposing of the computer and the computer's batteries

- Discard this computer in accordance with applicable laws and regulations. For further information, contact your local government.
- This computer contains rechargeable batteries. After repeated use, the batteries will finally lose their ability to hold a charge and you need to replace them. Under certain applicable laws and regulation, it might be illegal to dispose of old batteries by placing them in the trash.

- Please be kind to our shared environment. Check with your local government authority for details regarding where to recycle old batteries or how to dispose of them properly.

Optical disc drive safety instructions



Be sure to check the precautions at the end of this section.



- *The drive model employs a laser system. To ensure proper use of this product, read this instruction manual carefully and retain for future reference. Should the unit ever require maintenance, contact an authorized service location.*
- *Use of controls, adjustments or the performance of procedures other than those specified might result in hazardous radiation exposure.*
- *To prevent direct exposure to the laser beam, do not try to open the enclosure.*

Location of the Required Label

(Sample shown below. Location of the label and manufacturing information might vary.)

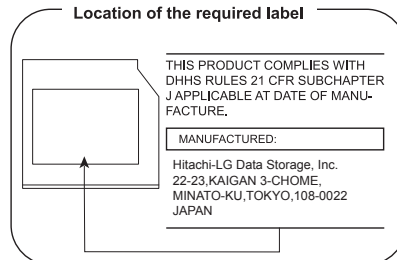

Precautions

CLASS 1 LASER PRODUCT LASER KLASSE 1 PRODUKT TO EN 60825-1 クラス1レーザー製品
--

CAUTION: This appliance contains a laser system and is classified as a “CLASS 1 LASER PRODUCT.” To use this model properly, read the instruction manual carefully and keep this manual for your future reference. In case of any trouble with this model, please contact your nearest “AUTHORIZED service station.” To prevent direct exposure to the laser beam, do not try to open the enclosure.

General Precautions

TOSHIBA computers are designed to optimize safety, minimize strain and withstand the rigors of portability. However, certain precautions should be observed to further reduce the risk of personal injury or damage to the computer.

Be certain to read the following general precautions and to note the cautions included in the text of the manual.

Provide adequate ventilation

Always make sure that your computer and AC adaptor have adequate ventilation and are protected from overheating when the power is turned on or when an AC adaptor is connected to a power outlet (even if your computer is in Sleep Mode). In this condition, observe the following:

- Never cover your computer or AC adaptor with any object.
- Never place your computer or AC adaptor near a heat source, such as an electric blanket or heater.
- Never cover or block the air vents including those at the base of the computer.
- Always operate your computer on a hard flat surface. Using your computer on a carpet or other soft material can block the vents.
- Always provide sufficient space around the computer.

Overheating your computer or AC adaptor could cause system failure, computer or AC adaptor damage or a fire, possibly resulting in serious injury.

Creating a computer-friendly environment

Place the computer on a flat surface that is large enough for the computer and any other items you are using, such as a printer.

Leave enough space around the computer and other equipment to provide adequate ventilation. Otherwise, they might overheat.

To keep your computer in prime operating condition, protect your work area from:

- Dust, moisture, and direct sunlight.
- Equipment that generates a strong electromagnetic field, such as stereo speakers (other than speakers that are connected to the computer) or speakerphones.
- Rapid changes in temperature or humidity and sources of temperature change such as air conditioner vents or heaters.
- Extreme heat, cold, or humidity.
- Liquids and corrosive chemicals.

Stress injury

Carefully read the *Instruction Manual for Safety and Comfort*. It contains information on the prevention of stress injuries to your hands and wrists that can be caused by extensive keyboard use. It also includes information on work space design, posture, and lighting that can help reduce physical stress.

Heat injury

- Avoid prolonged physical contact with the computer. If the computer is used for long periods, its surface can become very warm. While the temperature will not feel hot to the touch, if you maintain physical contact with the computer for a long time, for example if you rest the computer on your lap or if you keep your hands on the palm rest, your skin might suffer a low-heat injury.
- If the computer has been used for a long time, avoid direct contact with the metal plate supporting the various interface ports as this can become hot.
- The surface of the AC adaptor can become hot when in use but this condition does not indicate a malfunction. If you need to transport the AC adaptor, disconnect it and let it cool before moving it.
- Do not lay the AC adaptor on a material that is sensitive to heat as the material could become damaged.

Pressure or impact damage

Do not apply heavy pressure to the computer or subject it to any form of strong impact as this can damage the computer's components or otherwise cause it to malfunction.

Cleaning the computer

To help ensure long, trouble-free operation, keep the computer free of dust and dirt, and use care with all liquids around it.

-
- Be careful not to spill liquids into the computer. If the computer does get wet, turn the power off immediately and let the computer dry completely. In these circumstances, you should get the computer inspected by an authorized service provider in order to assess the scope of any damage.
 - Clean the plastics of the computer using a cloth slightly dampened with water.
 - You can clean the display screen by spraying a small amount of glass cleaner onto a soft, clean cloth and then wiping the screen gently with the cloth.



Never spray cleaner directly onto the computer or let liquid run into any part of it. Never use harsh or caustic chemical products to clean the computer.

Moving the computer

While the computer is designed for flexible day-to-day usage, you should exercise a few simple precautions when moving it in order to help ensure trouble-free operation.

- Make sure all disk/disc activity has ended before moving the computer.
- Turn off (shut down) the computer.
- Disconnect the AC adaptor and all peripherals before moving the computer.
- Close the display panel.
- Do not pick up the computer by its display panel.
- Before carrying your computer, shut it down, disconnect the AC adaptor and allow it to cool down. A failure to follow this instruction might result in minor heat injury.
- Do not expose the computer to rapid temperature changes (for example, in a situation where you carry the computer from a cold environment to a warm room). Do not turn on the power until condensation disappears.
- Be careful not to subject the computer to impact or shock. A failure to follow this instruction could result in damage to computer, computer failure, or loss of data.
- Never transport your computer with any cards installed. This might damage either the computer and/or the card resulting in computer failure.
- Always use a suitable carry case when transporting the computer.
- When carrying your computer, be sure to hold it securely so that it does not fall or hit anything.
- Do not carry your computer by holding any of its protruding elements.

Mobile phones

Be aware that the use of mobile phones can interfere with the audio system. The operation of the computer will not be impaired in any way, but it is recommended that a minimum distance of 30 cm is maintained between the computer and a mobile phone that is in use.

Instruction Manual for Safety and Comfort

All important information on the safe and proper use of this computer is described in the enclosed Instruction Manual for Safety and Comfort. Be sure to read it before using the computer.

Safety Icons

Safety icons are used in this manual to bring important information to your attention. Each type of message is identified as follows.



Indicates a potentially hazardous situation, which could result in death or serious injury, if you do not follow instructions.



A caution informs you that improper use of equipment or failure to follow instructions might cause data loss, equipment damage, or might result in minor or moderate injury.



Please read. A note is a hint or advice that helps you make best use of your equipment.

Chapter 2

Getting Started

This chapter provides an equipment checklist, and basic information to start using your computer.



If you use an operating system that was not pre-installed by TOSHIBA, some of the features described in this manual might not function properly.

Equipment checklist

Carefully unpack your computer, taking care to save the box and packaging materials for future use.

Hardware

Check to make sure that you have all the following items:

- TOSHIBA Portable Personal Computer
- Battery pack (preinstalled in the computer)
- AC adaptor and power cord (2-pin plug or 3-pin plug)

Documentation

- Quickstart
- Instruction Manual for Safety and Comfort
- Warranty information

If any of the items are missing or damaged, contact your dealer immediately.

Conventions

This manual uses the following formats to describe, identify, and highlight terms and operating procedures.

Click	<ul style="list-style-type: none">■ Tap the Touch Pad or click the left Touch Pad control button once.■ Left click the mouse once.
Right-click	<ul style="list-style-type: none">■ Click the right Touch Pad control button once.■ Right-click the mouse once.

Double-click

- Tap the Touch Pad or click the left Touch Pad control button twice.
- Left click the mouse twice.

Start

The word "Start" refers to the "  " button in the lower-left corner of the screen.

Using your computer for the first time



Be sure to read the enclosed Instruction Manual for Safety and Comfort for information on the safe and proper use of this computer. It is intended to help you be more comfortable and productive while using a notebook computer. By following the recommendations in it, you can reduce your chance of developing a painful or disabling injury to your hand, arms, shoulders, or neck.

This section provides basic information to start using your computer. It covers the following topics:

- Connecting the AC adaptor
- Opening the display
- Turning on the power
- Initial setup
- Getting to know Windows



- *Use a virus-check program and make sure that it is updated regularly.*
- *Never format storage media without checking its content - formatting destroys all stored data.*
- *It is a good idea to back up the internal storage drive or other main storage device to external media periodically. General storage media is not durable or stable over long periods of time and under certain conditions might result in data loss.*
- *Before you install a device or application, save any data in memory to the internal storage drive or other storage media. Failure to do so might result in data loss.*

Connecting the AC adaptor

Attach the AC adaptor when you want to charge the battery or operate from AC power. The battery pack must be charged before you can operate from battery power.

The AC adaptor can automatically adjust to any voltage ranging from 100 volts to 240 volts and to a frequency of either 50 hertz or 60 hertz, enabling you to use this computer in almost any country/region. The adaptor converts AC power to DC power and reduces the voltage supplied to this computer.



- Always use the TOSHIBA AC adaptor that was included with your computer, or use AC adaptors specified by TOSHIBA to avoid any risk of fire or other damage to the computer. Use of an incompatible AC adaptor might cause fire or damage to the computer possibly resulting in serious injury. TOSHIBA assumes no liability for any damage caused by use of an incompatible adaptor.
- Never plug the AC adaptor into a power source that does not correspond to both the voltage range and the frequency specified on the regulatory label of the unit. Failure to do so might result in a fire or electric shock, possibly resulting in serious injury.
- Always use or purchase power cables that comply with the legal voltage and frequency specifications and requirements in the country of use. Failure to do so might result in a fire or electric shock, possibly resulting in serious injury.
- The supplied power cord conforms to safety rules and regulations in the region the computer is bought and should not be used outside this region. For use in other regions, buy power cords that conform to safety rules and regulations in the particular region.
- Do not use a 3-pin to 2-pin conversion plug.
- When you connect the AC adaptor to the computer, always follow the steps in the exact order as described in this User's Manual. Connecting the power cable to a live electrical outlet should be the last step otherwise the adaptor DC output plug might hold an electrical charge and cause an electrical shock or minor bodily injury when touched. As a general safety precaution, avoid touching any metal parts.
- Never place your computer or AC adaptor on a wooden surface, furniture, or any other surface that might be marred by exposure to heat since the computer base and the surface of the AC adaptor increase in temperature during normal use.
- Always place your computer or AC adaptor on a flat and hard surface that is resistant to heat damage.

Refer to the enclosed Instruction Manual for Safety and Comfort for detailed precautions and handling instructions.

1. Connect the power cord to the AC adaptor.

Figure 2-1 Connecting the power cord to the AC adaptor (2-pin plug)

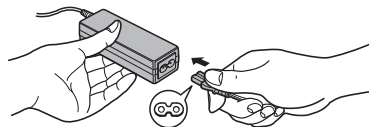
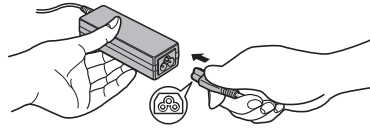

Figure 2-2 Connecting the power cord to the AC adaptor (3-pin plug)



Either a 2-pin or 3-pin adaptor/cord is included with the computer depending on the model.

2. Connect the DC output plug of the AC adaptor to the DC IN 19V jack on your computer.

Figure 2-3 Connecting the DC output plug to the computer

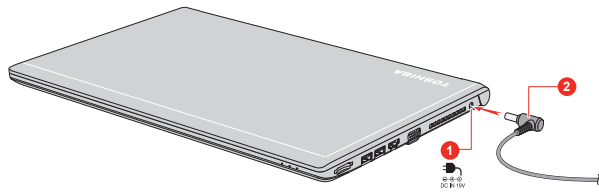

1. DC IN 19V jack

2. DC output plug

Product appearance depends on the model you purchased.

3. Plug the power cord into a live wall outlet. The **DC IN/Battery** indicator glows.

Opening the display

The display panel can be opened to a wide range of angles for optimal viewing.

While holding down the palm rest with one hand so that the main body of the computer is not raised, slowly lift the display panel. This will allow the angle of the display panel to be adjusted to provide optimum clarity.

Figure 2-4 Opening the display panel

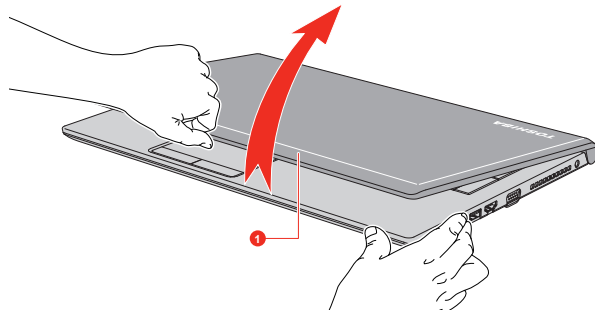

1. Display panel



- *Open and close the display panel with reasonable care. Opening it vigorously or slamming it shut might damage the computer.*
- *Do not put your fingers in the gap between the LCD panel and battery pack when closing your LCD, otherwise your fingers might get hurt.*



- *Be careful not to open the display panel too far as this might put stress on the display panel's hinges and cause damage.*
- *Do not press or push on the display panel.*
- *Do not lift the computer by the display panel.*
- *Do not close the display panel with pens or any other objects left in between the display panel and the keyboard.*
- *When opening or closing the display panel, place one hand on the palm rest to hold the computer in place and use the other hand to slowly open or close the display panel (Do not use excessive force when opening or closing the display panel).*

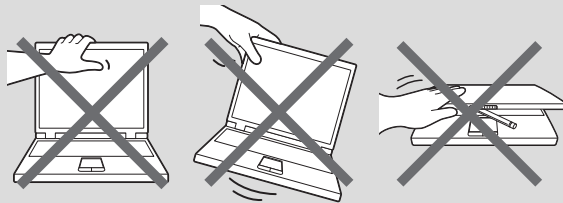

Turning on the power

This section describes how to turn on the power. The Power indicator indicates the status. Refer to the [Power Condition Descriptions](#) section for more information.



- *After you turn on the power for the first time, do not turn it off until you have set up the operating system.*
- *Volume cannot be adjusted during Windows Setup.*

1. Open the display panel.
2. Press the power button.

Figure 2-5 Turning on the power



1. Power button

Product appearance depends on the model you purchased.

Initial setup

The Windows Startup Screen is the first screen displayed when you turn on the power. To install the operating system properly, follow the on-screen instructions on each screen.



When it is displayed, be sure to read the license terms and license agreement carefully.



Getting to know Windows

For detailed information on what is new and how to operate Windows, refer to the **Tips** in the Start menu.

Start menu

The Start menu is the launching pad for everything you can do in the Windows operating system, providing easy ways to access your apps, programs, websites and other important information.

You can access the Start menu from an app or the desktop in the following ways:

- Click the **Start** button () in the lower-left corner of the screen.
- Press the Windows® logo key () on your keyboard.

You can pin your favorite apps to the Start menu as tiles in grid-like pattern, and also group them. Tiles show you dynamic information from apps without having to open them.

Windows taskbar

By default, the bottom of the desktop is Windows taskbar. You can see all of your currently running apps on the Windows taskbar.

Task view

Task view () is launched from Windows taskbar at the bottom of the screen. Task view allows you to view the apps that are currently running. Also, you can create custom desktops so that running apps can be grouped for entertainment, productivity, or what you just want.

To do this, click the **Task view** icon , and then click **New desktop**. Open the apps you want to use on that desktop. To switch between desktops, click **Task view** again.

Search

Search on the Windows taskbar allows you to find apps, files, settings, and more on the computer. When Internet connection is available, it also shows you the best search result from the Internet.

The personal assistant called **Cortana** might be available depending on your country/region. You can ask questions or talk to Cortana in natural voice, and Cortana answers your questions using information from the Internet. To use Cortana, an internal or external microphone is required.

Action center

You can review important notifications from apps or Windows in action center, and take action without having to open apps. It also provides quick action buttons to access to most-used settings instantly. Select the action center icon  on the Windows taskbar to view your notifications and quick actions.

Settings

Settings provides system settings including advanced settings in the Control Panel. They are divided in categories so that you can configure, optimize, or personalize Windows.

You can also type in the keyword, and use **Search** to find any setting.

To open Settings, click **Start** ->  (**Settings**).

You can pin it to the Start menu as a tile by right-clicking on **Settings** and selecting **Pin to Start**.

Windows Store

Although many apps are pre-installed in your computer, you can also download many others from the Windows Store.

You can search for and browse thousands of apps, all grouped into easy-to-find categories there.

Windows Hello

Windows Hello is a more personal and secure way to sign in to your Windows system, apps, and services using fingerprint or face recognition.

To set up Windows Hello, click **Start** -> ⚙️ (**Settings**) -> **Accounts** -> **Sign-in options**.

Under Windows Hello, you will see options for Face Recognition and Fingerprint if your computer has fingerprint sensor and if your computer has face recognition sensor that supports it. Once you have set up, you will be able to sign in with a quick touch or glance.

You might need to add a PIN before you can set up Windows Hello.

Sign-in options

Windows offers a number of sign-in options including **Password** (🔑), **PIN** (1234), **Fingerprint** (👉), **Face** (😊) and **Picture password** (📧) authentication to prevent from unauthorized access. If you have multiple sign-in methods set for a user account, you can select an option on the Windows login screen by clicking sign-in options. Password authentication is the default sign-in option.



It is highly recommended to use Windows Hello (Face recognition) indoors. Operating outdoors might cause enrollment/sign-in failure due to the possible sunlight affection.

Turning off the power

The power can be turned off in one of the following modes, either Shut Down Mode, Sleep Mode or Hibernation Mode.

Shut Down Mode

When you turn off the power in Shut Down Mode, no data will be saved and the computer will boot to the main screen of the operating system the next time it is turned on.

1. If you have entered data, either save it to the internal storage drive or to other storage media.

2. Make sure all disk/disc activity has stopped before removing the disk/disc.



- *If you turn off the power while a disk (disc) is being accessed, you might lose data or damage the disk.*
- *Never turn off the power while an application is running. Failure to do so can cause data loss.*
- *Never turn off the power, disconnect an external storage device, or remove storage media during data read/write. Failure to do so can cause data loss.*

3. Click **Start** ->  (**Power**) and then select **Shut down**.
4. Turn off any peripheral devices connected to your computer.





Do not turn the computer or peripheral devices back on immediately. Wait a short period to avoid any potential damage.

Restarting the computer

Certain conditions require that you restart the computer, for example if you change certain computer settings.

To restart the computer, there are several ways this can be achieved:

- Click **Start** ->  (**Power**) and then select **Restart**.
- Press **CTRL**, **ALT**, and **DEL** simultaneously (once) to display the menu window, and then select **Restart** by clicking the power icon () in the lower-right corner.



Before restarting the computer, be sure to save your data.

Sleep Mode

If you have to interrupt your work, you are able to turn off the power without exiting from your software by placing the computer into Sleep Mode. In this mode, data is maintained in the main memory of the computer. When you turn on the power again, you can continue working right where you left off.



When you have to turn off your computer aboard an aircraft or in places where electronic devices are regulated or controlled, always shut down the computer. This includes turning off any wireless communication functionalities, and canceling settings that reactivate the computer automatically, such as a timer recording function. Failure to shut down the computer in this way might allow the operating system to reactivate and run pre-programmed tasks or preserve unsaved data, which might interfere with aviation or other systems, possibly causing serious injury.



- *Before entering Sleep Mode, be sure to save your data.*
- *To prevent data loss, do not switch to Sleep Mode while transferring data to external media, such as USB devices, memory media, or other external memory devices.*
- *Do not remove the battery pack while the computer is in Sleep Mode (unless the computer is connected to an AC power source). It can cause data loss in the memory.*



- *When the AC adaptor is connected, the computer will go into Sleep Mode according to the settings in the Power Options (to access it, click **Start -> Windows System -> Control Panel -> System and Security -> Power Options**).*
- *To restore the operation of the computer from Sleep Mode, press and hold the power button or any key on the keyboard for a short amount of time. Note that keyboard keys can only be used if the Wake-up on Keyboard option is enabled within the TOSHIBA Settings.*
- *If the computer enters Sleep Mode while a network application is active, the application might not be restored when the computer is next turned on and the system returns from Sleep Mode.*
- *To prevent the computer from automatically entering Sleep Mode, disable Sleep Mode within the Power Options.*
- *To use the Hybrid Sleep function, configure it in the Power Options.*

Benefits of Sleep Mode

The Sleep Mode feature provides the following benefits:

- Restores the previous working environment more rapidly than the Hibernation Mode feature.
- Saves power by shutting down the system when the computer receives no input or hardware access for the time period set by the System Sleep Mode feature.
- Allows the use of the panel power off feature.

Executing Sleep Mode

You can enter Sleep Mode in one of following ways:

- Click **Start ->  (Power)** and then select **Sleep**.
- Close the display panel. Note that this feature must be enabled within the Power Options.
- Press the power button. Note that this feature must be enabled within the Power Options.

When you turn the power back on, you can continue where you left off when you shut down the computer.



- *When the computer is in Sleep Mode, the Power indicator blinks amber.*
- *If you are operating the computer on battery power, you can lengthen the overall operating time by turning it off into Hibernation Mode. Sleep Mode consumes more power while the computer is off.*

Sleep Mode limitations

Sleep Mode will not function under the following conditions:

- Power is turned back on immediately after shutting down.
- Memory circuits are exposed to static electricity or electrical noise.
- The battery power is exhausted and the AC Adaptor is not connected.

Hibernation Mode

The Hibernation Mode feature saves the contents of memory to the internal storage drive when the computer is turned off so that, the next time it is turned on, the previous state is restored. Note that the Hibernation Mode feature does not save the status of any peripheral devices connected to the computer.



- *Save your data. While entering Hibernation Mode, the computer saves the contents of memory to the internal storage drive. However, for safety sake, it is best to save your data manually.*
- *Data will be lost if you remove the battery or disconnect the AC adaptor before the save is completed.*
- *To prevent data loss, do not switch to Hibernation Mode while transferring data to external media, such as USB devices, memory media, or other external memory devices.*

Benefits of Hibernation Mode

The Hibernation Mode feature provides the following benefits:

- Saves data to the internal storage drive when the computer automatically shuts down because of a low battery condition.
- You can return to your previous working environment immediately when you turn on the computer.
- Saves power by shutting down the system when the computer receives no input or hardware access for the time period set by the System Hibernate feature.
- Allows the use of the panel power off feature.

Starting Hibernation Mode

To enter Hibernation Mode, click **Start** ->  (**Power**) and then select **Hibernate**.



To show **Hibernate** in Power menu, set up according to the following steps:

1. Click **Start -> Windows System -> Control Panel -> System and Security -> Power Options**.
2. Click **Choose what the power button does** or **Choose what closing the lid does**.
3. Click **Change settings that are currently unavailable**.
4. Select the **Hibernate** check box from Shutdown settings.
5. Click the **Save changes** button.

Automatic Hibernation Mode

The computer can be configured to enter Hibernation Mode automatically when you press the power button or close the display panel. To define these settings, do the following:

1. Click **Power Options** and then click **Choose what the power button does** or **Choose what closing the lid does**.
2. Enable the desired Hibernation Mode settings for **When I press the power button** and **When I close the lid**.
3. Click the **Save changes** button.

Data save in Hibernation Mode

When you turn off the power in Hibernation Mode, the computer takes a moment to save the current data in memory to the internal storage drive.

After you turn off the computer, and the content of memory has been saved to the internal storage drive, turn off the power to any peripheral devices.



Do not turn the computer or devices back on immediately. Wait a moment to let all capacitors fully discharge.

System Recovery

There is a hidden partition allocated on the internal storage drive for the System Recovery Options in the event of a problem.

You can also create recovery media and restore the system.

The following items are described in this section:

- Creating Recovery Media
- Restoring the pre-installed software from your created Recovery Media
- Restoring the pre-installed software from the Recovery Partition



If you choose TOSHIBA Maintenance Utility to erase the internal storage drive, all data including the operating system and recovery partition will be

deleted. In that case, you cannot create recovery media or restore the pre-installed software from the recovery partition. Make sure that you have already created recovery media before you start TOSHIBA Maintenance Utility. This recovery media can be used to restore your system after you have erased your internal storage drive.

Creating Recovery Media

This section describes how to create Recovery Media.



- *Be sure to connect the AC adaptor when you create Recovery Media.*
- *Be sure to close all other software programs except the Recovery Media Creator.*
- *Do not run software such as screen savers which can put a heavy load on the CPU.*
- *Operate the computer at full power.*
- *Do not use power-saving features.*
- *Do not write to the media when the virus check software is running. Wait for it to finish, then disable virus detection programs including any software that checks files automatically in the background.*
- *Do not use utilities, including those intended to enhance internal storage drive access speed. They might cause unstable operation and damage data.*
- *Do not shut down/log off or Sleep/Hibernate while writing or rewriting the media.*
- *Set the computer on a level surface and avoid places subjected to vibrations such as airplanes, trains, or cars.*
- *Do not use on an unstable surface such as a stand.*

A recovery image of the software on your computer is stored on the internal storage drive, and can be copied to either disc media or USB Flash Memory by using the following steps:

1. Select either blank disc or USB Flash Memory.
The application allows you to choose from a variety of different media onto which the recovery image can be copied including disc media and USB Flash Memory.



- *Some of the disc media might not be compatible with the optical disc drive connected to your computer. You should therefore verify that the optical disc drive supports the blank media you have chosen before proceeding.*
- *USB Flash Memory will be formatted and all the data in the USB Flash Memory will be lost when proceeding.*

2. Turn on your computer and allow it to load the Windows operating system from the internal storage drive as normal.
3. Insert the first blank disc into the optical disc drive tray, or insert the USB Flash Memory into one available USB port.
4. Click **Start -> Windows System -> Control Panel -> System and Security -> Security and Maintenance -> Recovery -> Create a recovery drive**.
5. Follow the on-screen instructions to finish creating the Recovery Media.



TOSHIBA Recovery Wizard option in TOSHIBA Maintenance Utility will not exist if you restore the computer from the recovery media you created by recovery drive creating option in Windows system.

Restoring the pre-installed software from your created Recovery Media

If the pre-installed files are damaged, you are able to use the Recovery Media you have created to restore the computer to the state it was in when you originally received it. To perform this restoration, do the following:



- *When you reinstall the Windows operating system, the hard disk will be reformatted and all data will be lost.*
 - *If your model has fingerprint function, before you reinstall the Windows operating system, delete the registered fingerprints. Otherwise, same fingerprints cannot be registered after the reinstallation.*
 - *Make sure to use the default Boot Mode option in TOSHIBA Setup Utility before restoring.*
1. *Launch the TOSHIBA Setup Utility.*
Refer to the [TOSHIBA Setup Utility](#) section for further information.
 2. *In the TOSHIBA Setup Utility screen, select **Advanced -> System Configuration -> Boot Mode**.*
Note: *Please skip the following contents if you cannot find the Boot Mode option in your system.*
 3. *Select **UEFI Boot** (Default).*
*If you create a recovery image using advanced recovery tools from Control Panel, make sure to use the default Boot Mode option (**UEFI Boot**) in the TOSHIBA Setup Utility before restoring.*



- *Make sure that the AC adaptor is connected during the restoring process.*
- *Do not close the display panel during the restoring process.*

1. Load the Recovery Media into the Optical Disc Drive or insert the recovery USB Flash Memory into one available USB port.

2. Click **Start** ->  (**Power**) and then select **Restart**.
3. Hold down the **F12** key and then release this key just after the computer is power on.
4. Use the up and down cursor key to select the appropriate option from the menu according to your actual recovery media.
5. A menu is displayed from which you should follow the on-screen instructions.



If you have previously chosen to remove the recovery partition without creating Recovery Media, the Recovery Media cannot be created.

However, if you have already created a Recovery Media, you can use it to restore the recovery partition.

If you have not created Recovery Media, contact TOSHIBA support for assistance.

Restoring the pre-installed software from the Recovery Partition

A portion of the total internal storage drive space is configured as a hidden recovery partition. This partition stores files which can be used to restore pre-installed software in the event of a problem.

If you set up your internal storage drive again later, do not change, delete, or add partitions in a manner other than specified in the manual, otherwise you might find that space for the required software is not available.

In addition, if you use a third-party partitioning program to reconfigure the partitions on your internal storage drive, you might find that it becomes impossible to set up your computer.



- *Make sure that the AC adaptor is connected during the restoring process.*
- *Do not close the display panel during the restoring process.*



- *When you reinstall the Windows operating system, the internal storage drive will be reformatted and all data will be lost.*
- *If your model has fingerprint function, before you reinstall the Windows operating system, delete the registered fingerprints. Otherwise, same fingerprints cannot be registered after the reinstallation.*

1. Click **Start** ->  (**Power**) and then select **Restart**.
2. Hold down **0** (zero) key and then release this key just after the computer is power on.
3. Select **Troubleshoot** -> **TOSHIBA Maintenance Utility** -> **TOSHIBA Recovery Wizard**.
4. Follow the on-screen instructions to finish the recovery.

Chapter 3

The Grand Tour

This chapter identifies the various components of the computer. It is recommended that you become familiar with each before you operate the computer.

Legal Footnote (Non-applicable Icons)

For more information regarding Non-applicable Icons, refer to the [Legal Footnotes](#) section.



Handle your computer carefully to avoid scratching or damaging the surface.

Front with the display closed

The following figure shows the front of the computer with the display panel in the closed position.

Figure 3-1 Front of the computer with display panel closed

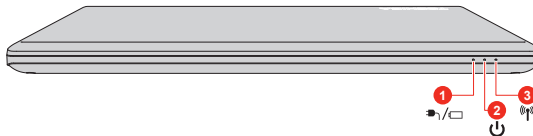

1. DC IN/Battery indicator
2. Power indicator

3. Wireless communication indicator

Product appearance depends on the model you purchased.



DC IN/Battery indicator

The **DC IN/Battery indicator** shows the condition of the DC IN and the battery charge status. White indicates that the battery is fully charged while the power is being correctly supplied from the AC power adaptor.

Refer to the [Power Condition Descriptions](#) section for more information on this feature.



Power indicator

The **Power indicator** normally glows white when the computer is turned on. However, if you turn off the computer into Sleep Mode, this indicator flashes amber.



Wireless communication indicator

The **Wireless communication indicator** glows white when the wireless functions are turned on. Some models are equipped with wireless functions.

Left side

The following figures show the left side of the computer.

Figure 3-2 The left side of the computer

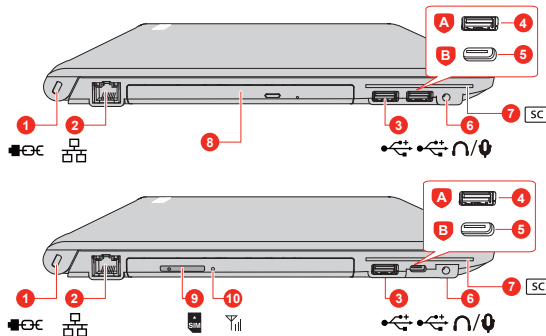

- | | |
|---|------------------------------|
| 1. Security lock slot | 6. Headphone/Microphone jack |
| 2. LAN jack | 7. Smart Card slot* |
| 3. Universal Serial Bus (USB 2.0 or 3.0) port | 8. Optical disc drive* |
| 4. Universal Serial Bus (USB 2.0 or 3.0) port | 9. SIM card slot* |
| 5. USB Type-C(USB 3.1 Gen1) port* | 10. Wireless WAN indicator* |

* Provided with some models.

Product appearance depends on the model you purchased.



Security lock slot

A security cable can be attached to this slot and then connected to a desk or other large object in order to deter theft of the computer.



LAN jack

This jack lets you connect to a LAN. The adaptor has built-in support for Ethernet LAN (10 megabits per second, 10BASE-T), Fast Ethernet LAN (100 megabits per second, 100BASE-TX) or Gigabit Ethernet LAN (1000 megabits per second, 1000BASE-T). Refer to [Operating Basics](#), for details.



Do not connect any cable other than a LAN cable to the LAN jack. It might cause damage or malfunction.



Universal Serial Bus (USB 2.0 or 3.0) port

One or two Universal Serial Bus port, which complies to the USB 2.0 or 3.0 standard, is provided on the left side of the computer.

The USB 2.0 port is not compatible with USB 3.0 devices.



USB Type-C (USB 3.1 Gen1)port

One Universal Serial Bus port, which complies to the USB 3.1 Gen1 standard, is provided on the left side of the computer.

USB Type-C (USB3.1 Gen1) port supports USB 2.0 with theoretical maximum transmissionrate at 480Mbps and USB 3.1 Gen1 (DC5V,900mA) with theoretical maximum transmissionrate at 5Gbps. This port supports only the USB data transmission.

Some models are equipped with a USB Type-C (USB 3.1 Gen1)port.



- *Note that it is not possible to confirm the operation of all functions of all USB devices that are available. Some functions associated with a specific device might not operate properly.*
- *Before removing a USB device from the USB port, click the **Safely Remove Hardware and Eject Media** icon on the Windows Taskbar, and then select the USB device that you want to remove.*



Keep foreign metal objects, such as screws, staples, and paper clips, out of the USB port. Foreign metal objects can create a short circuit, which can cause damage and fire, possibly resulting in serious injury.



Headphone/ Microphone jack

A 3.5 mm mini headphone/microphone jack enables connection of a monaural microphone, stereo headphones, or a headset.

SC

Smart Card slot

This slot allows you to install a Smart Card device.

Some models are equipped with a Smart Card slot.

Optical disc drive

The computer is configured with a DVD Super Multi drive.

Some models are equipped with an optical disc drive.



2.6GB and 5.2GB DVD-RAM media cannot be read from or written to.



SIM Card slot

This slot allows you insert a SIM card which enables a high-speed access to the Internet, corporate Intranet and your email while you are away from office.

Refer to the [Wireless WAN Device](#) section for more information.

Some models are equipped with a SIM Card slot.



Wireless WAN indicator

The **Wireless WAN** glows blue when the Wireless WAN functions are turned on.

For some models, the indicator blinks to indicate the connection status of the Wireless WAN function.

Some models are equipped with the Wireless WAN function.

Right side

The following figures show the right side of the computer.

Figure 3-3 The right side of the computer

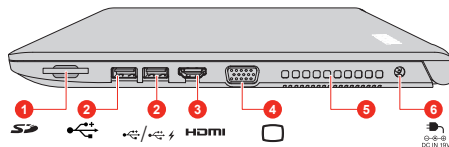

1. Memory media slot
2. Universal Serial Bus (USB 3.0) port
3. HDMI™ out port
4. External RGB monitor port
5. Cooling vents
6. DC IN 19V jack

Product appearance depends on the model you purchased.



Memory media slot

This slot lets you insert an SD™/SDHC™/SDXC™ memory card, miniSD™/microSD™ Card and MultiMediaCard™. Refer to the [Memory media](#) section for more information.



Keep foreign metal objects, such as screws, staples, and paper clips, out of the Memory media slot. Foreign metal objects can create a short circuit, which can cause damage and fire, possibly resulting in serious injury.



Universal Serial Bus (USB 3.0) port

Two Universal Serial Bus ports, which comply to the USB 3.0 standard, are provided on the right side of the computer.

USB 3.0 port is compliant with USB 3.0 standard and backward compatible with USB 2.0 devices.

The port with the icon (⚡) has Sleep and Charge function, and this function is only provided with some models.



- *USB 3.0 port(s) might work as USB 2.0 port(s) when operating in USB Legacy Emulation mode.*
- *Note that it is not possible to confirm the operation of all functions of all USB devices that are available. Some functions associated with a specific device might not operate properly.*
- *Before removing a USB device from the USB port of your computer, click the **Safely Remove Hardware and Eject Media** icon on the Windows Taskbar, and then select the USB device that you want to remove.*



Keep foreign metal objects, such as screws, staples, and paper clips, out of the USB port. Foreign metal objects can create a short circuit, which can cause damage and fire, possibly resulting in serious injury.



HDMI™ out port

HDMI™ out port can connect with Type A connector HDMI™ cable.



External RGB monitor port

This port provides 15-pin, analog RGB port. Refer to the [External RGB monitor port pin assignment](#) section for information on external RGB monitor port pin assignment. This port allows you to connect an external RGB monitor to the computer.

Cooling vents

The cooling vents help the processor to avoid overheating.



Do not block the cooling vents. Keep foreign metal objects, such as screws, staples, and paper clips, out of the cooling vents. Foreign metal objects can create a short circuit, which can cause damage and fire, possibly resulting in serious injury.

Carefully clean the dust on the surface of the cooling vents using a soft cloth.



DC IN 19V jack

The AC adaptor connects to this jack in order to power the computer and charge its internal batteries. Note that you must only use the model of AC adaptor supplied with the computer at the time of purchase. Using the wrong AC adaptor can damage the computer.

Back

The following figure shows the back of the computer.

Figure 3-4 The back of the computer

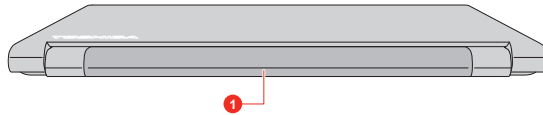

1. Battery pack

Product appearance depends on the model you purchased.

Battery pack

The rechargeable lithium-ion battery pack provides power to the computer when the AC adaptor is not connected.

For more detailed information on the use and operation of the battery pack, refer to the [Battery](#) section.

Legal Footnote (Battery Life)

For more information regarding Battery Life, refer to the [Legal Footnotes](#) section.

Underside

The following figures show the underside of the computer. Ensure that the display is closed before the computer is turned over to avoid causing any damage.

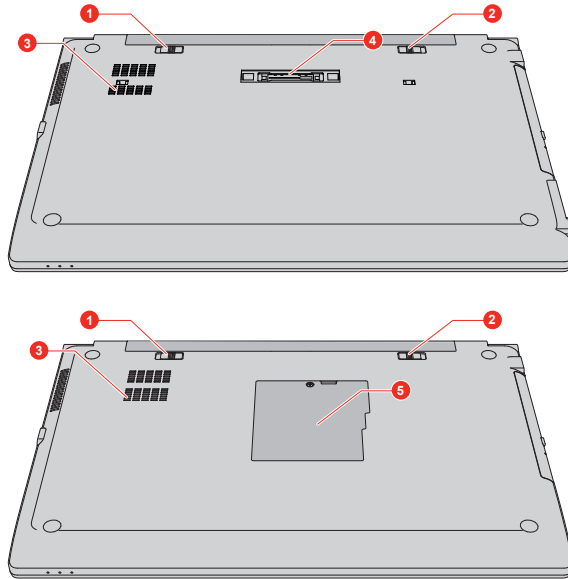

Figure 3-5 The underside of the computer



- 1. Battery lock
- 2. Battery release latch
- 3. Cooling vents
- 4. Docking port*
- 5. Memory module cover*

* Provided with some models.

Product appearance depends on the model you purchased.

-
- | | | |
|---|---------------------|---|
| 1   | Battery lock | Slide the battery lock to release the battery pack ready for removal. |
|---|---------------------|---|
-
- | | | |
|---|------------------------------|--|
| 2  | Battery release latch | Slide and hold this latch into its "Unlock" position in order to release the battery pack for removal. For more detailed information on removing the battery pack, refer to the Battery section. |
|---|------------------------------|--|
-

Cooling vents

The cooling vents help the processor to avoid overheating.



Do not block the cooling vents. Keep foreign metal objects, such as screws, staples, and paper clips, out of the cooling vents. Foreign metal objects can create a short circuit, which can cause damage and fire, possibly resulting in serious injury.

Carefully clean the dust on the surface of the cooling vents using a soft cloth.



Docking port

This port enables connection of an optional TOSHIBA Hi-Speed Port Replicator III 180W/120W described in [TOSHIBA Hi-Speed Port Replicator III 180W/120W](#).

Some models are equipped with the docking port.



- *Only the TOSHIBA Hi-Speed Port Replicator III 180W or 120W is compatible with the docking port.*
- *Do not attempt to use any other Port Replicator.*
- *Keep foreign objects out of the docking port. A pin or similar object can damage the circuitry of the computer.*

Memory module cover

Some models are equipped with the memory module cover. The memory module slot under this cover allows for the installation, replacement and removal of additional memory module.

4GB, 8GB or 16GB memory modules can be installed in the computer's two memory slots for a maximum of 32GB system memory. The actual amount of useable system memory is less than the installed memory modules.

Refer to the [Additional memory module](#) section.

Front with the display open

This section shows the computer with the display panel open. In order to open the display, lift up the display panel and position it at a comfortable viewing angle for you.

Figure 3-6 The front of the computer with the display panel open

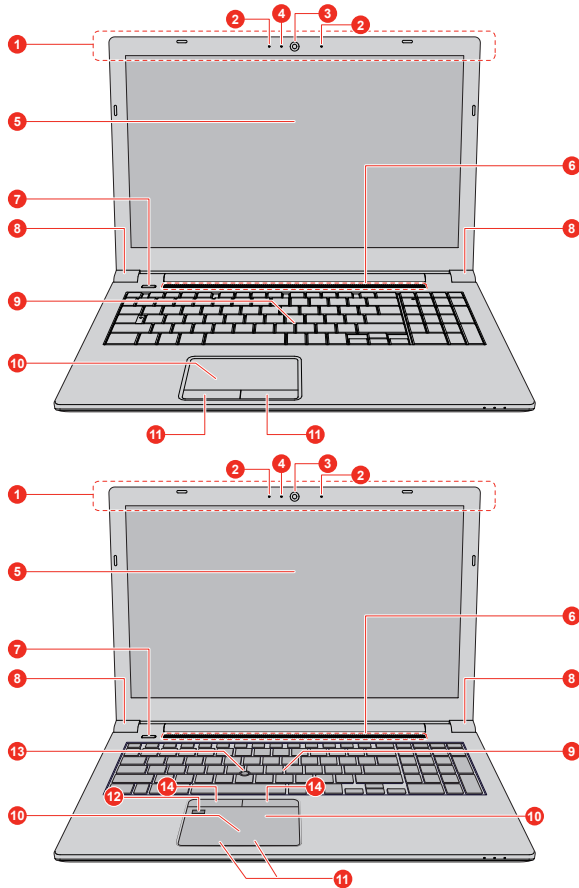

- | | |
|---|--------------------------------|
| 1. Wireless communication antennas (not shown)* | 8. Display hinges |
| 2. Microphones* | 9. Keyboard |
| 3. Web Camera* | 10. Touch Pad |
| 4. Web Camera LED* | 11. Touch Pad control buttons |
| 5. Display screen | 12. Fingerprint Sensor* |
| 6. Stereo speakers | 13. AccuPoint* |
| 7. Power button | 14. AccuPoint control buttons* |

* Provided with some models.

Product appearance depends on the model you purchased.

Wireless communication antennas

Depending on the configuration of your computer, one or all of the following antennas are built-in:

- Wireless LAN
- Wireless LAN/Bluetooth®

Some models are equipped with wireless communication antennas.



Do not cover the wireless communication antennas area with any metal objects, otherwise the wireless function might not work.

Legal Footnote (Wireless LAN)

For more information regarding Wireless LAN, refer to the [Legal Footnotes](#) section.

Microphones

The built-in microphones allow you to record sounds for your application. Refer to the [Sound System and Video mode](#) section for more information.

Some models are equipped with the built-in microphone.

Web Camera

Web Camera is a device that allows you to record video or take photographs with your computer. You can use it for video chatting or video conferences using a communication tool.

Some models are equipped with a Web Camera.



- *Do not point the web camera directly at the sun.*
- *Do not touch or press strongly on the web camera lens. Failure to do so might reduce image quality. Use an eyeglass cleaner (cleaner cloth) or other soft cloth to clean the lens if it becomes dirty.*

Web Camera LED

The Web Camera LED glows when the Web Camera is operating.

Some models are equipped with a Web Camera LED.

Display screen	<p>39.6 cm (15.6") LCD screen, is configured with the following resolution:</p> <ul style="list-style-type: none">■ HD, 1366 horizontal x 768 vertical pixels■ FHD, 1920 horizontal x 1080 vertical pixels <p>Be aware that, when the computer is operating on the AC adaptor, the image displayed on the internal screen is somewhat brighter than when it operates on battery power. This difference in brightness levels is intended to save power when operating on battery.</p>
-----------------------	---

Legal Footnote (LCD)

For more information regarding LCD, refer to the [Legal Footnotes](#) section.

Stereo speakers	<p>The speakers emit sound generated by your software as well as audio alarms, such as low battery condition, generated by the system.</p>
------------------------	--



Power button	<p>Press this button to power on/off the computer.</p>
---------------------	--

Display hinges	<p>The display hinges allow the display panel to be positioned at a variety of easy-to-view angles.</p>
-----------------------	---

Keyboard	<p>The keyboard contains character keys, control keys, function keys, and special Windows keys, providing all the functionality of a full-size keyboard.</p>
-----------------	--

Refer to the [The Keyboard](#) section for details.

Touch Pad	<p>The Touch Pad located in the palm rest is used to control the movement of the mouse pointer.</p> <p>To use the Touch Pad, simply touch and move your fingertip across it in the direction you want the mouse pointer to go.</p>
------------------	--

Touch Pad control buttons	<p>The two buttons below the Touch Pad are used like the buttons on a standard mouse. Press the left button to select a menu item or to manipulate text or graphics designated by the mouse pointer, and press the right button to display a menu or other function depending on the software you are using.</p>
----------------------------------	--

Fingerprint Sensor	<p>This sensor enables you to enroll and recognize a fingerprint.</p> <p>Some models are equipped with a Fingerprint Sensor.</p>
---------------------------	--

AccuPoint	A pointer control device located in the center of the keyboard is used to control the on-screen pointer. Some models are equipped with an AccuPoint.
AccuPoint control buttons	Control buttons below the keyboard let you select menu items or manipulate text and graphics designated by the on-screen pointer. Only models equipped with an AccuPoint are equipped with AccuPoint control buttons.

Internal Hardware Components

This section describes the internal hardware components of your computer. The actual specifications might vary depending on the model you purchased.

CPU	The processor type varies depending on model. To check which type of processor is included in your model, click Start -> Windows System -> Control Panel -> System and Security -> System .
------------	--

Legal Footnote (CPU)

For more information regarding CPU, refer to the [Legal Footnotes](#) section.

Internal Storage Drive	The capacity of the internal storage drive varies depending on the model. Note that part of the internal storage drive overall capacity is reserved as administration space.
-------------------------------	---



- *Some models are equipped with a "Solid-State Drive (SSD)" instead of a hard disk drive. In this manual, the word "HDD" or "Hard disk drive" also refers to the SSD unless otherwise stated.*
- *SSD is a large-capacity storage device which uses Solid-State Memory in place of a magnetic disk of the hard disk.*



Under certain unusual conditions of prolonged non-use and/or exposure to high temperatures, the HDD/SSD might be vulnerable to data retention errors.

Legal Footnote (Internal Storage Drive Capacity)

For more information regarding Internal Storage Drive Capacity, refer to the [Legal Footnotes](#) section.

RTC battery

The internal RTC battery backs up the Real-Time Clock (RTC) and calendar.

Power Condition Descriptions

The computer operating capability and battery charge status are affected by different power conditions, including whether an AC adaptor is connected and what the battery charge level is.

DC IN/Battery indicator

Check the **DC IN/Battery** indicator to determine the status of the battery pack and the power status with the AC adaptor connected. The following indicator conditions should be noted:

Flashing Amber	The battery charge is low. The AC adaptor must be connected to recharge the battery.
Amber	Indicates that the AC adaptor is connected and the battery is charging.
White	Indicates that the AC adaptor is connected and the battery is fully charged.
Flashing White	Indicates a problem with the computer. Disconnect the AC adaptor for several seconds, and remove the battery. Then reinstall the battery and reconnect the AC adaptor. If it still does not operate properly, you should contact your reseller or dealer.
No light	Under any other conditions, the indicator does not light.



*If the battery pack becomes too hot while it is being charged, the charge stops and the **DC IN/Battery** indicator goes out. When the temperature of the battery pack falls to a normal range, charging will resume. This process occurs regardless of whether the computer's power is on or off.*

Power indicator

Check the **Power** indicator to determine the power status of the computer. The following indicator conditions should be noted:

White	Indicates that power is being supplied to the computer, and the computer is turned on.
Flashing Amber	Indicates that the computer is in Sleep Mode and that there is sufficient power available (AC adaptor or battery) to maintain this condition.

No light

Under any other conditions, the indicator does not light.

Chapter 4

Operating Basics

This chapter describes the basic operations of your computer, and highlights the precautions that must be taken when using it.

Using the Touch Pad

The Touch Pad on the palm rest might support the following gestures:



Tap

Tap once on the Touch Pad to activate an item, such as an app.



Two-Finger Tap

Tap once on the Touch Pad with two fingers together to display a menu or other function depending on the software you are using. (Similar to right-click)



Pinch or stretch

Place two or more fingers down on the Touch Pad and move them toward each other (pinch) or away from each other (stretch). This shows different levels of information or visually zooms in or out.



Two-Finger Scroll

Place two fingers down and slide them vertically or horizontally from anywhere on the Touch Pad. This allows you to operate the scroll bars of a window.



Three-Finger Tap

Tap once on the Touch Pad with three fingers together to open Cortana (available depending on your country/region).



Three-Finger Scroll

Place three fingers down and slide them vertically or horizontally from anywhere on the Touch Pad. Slide towards left/right: switches between your open apps. Slide your fingers slowly across the Touch Pad to flip through them all. Slide up: views all your open apps in task view. Slide down: shows the desktop.



Four-Finger Tap

Tap once on the Touch Pad with four fingers together to open the Action center.



Four-Finger Scroll

Place four fingers down and slide them horizontally from anywhere on the Touch Pad to switch between virtual desktops.



Do not put items on the Touch Pad surface to prevent abnormal action.



Some of the Touch Pad operations described in this section are only supported in certain applications.

The Keyboard

The number of keys available on your keyboard depends on which country/region your computer is configured for, with keyboards being available for numerous languages.

There are different types of keys, specifically typewriter keys, function keys, and Windows special keys.



Never remove the key caps on your keyboard. Failure to do so might damage the parts under the key caps.

Keyboard indicator

The following figure shows the position of the **CAPS LOCK** indicator and **NUM LOCK** indicator which show the following conditions:

- When the **CAPS LOCK** indicator glows, the keyboard produces capitals when any letter is typed.
- When the **NUM LOCK** indicator glows, the ten key allows you to enter numbers.

Figure 4-1 Keypad indicator

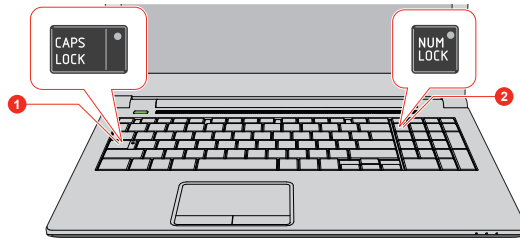

1. CAPS LOCK indicator

2. NUM LOCK indicator

CAPS LOCK	This indicator glows green when letter keys are locked into their uppercase format.
NUM LOCK	When the NUM LOCK indicator glows, you can use the number keys on the keyboard for number entry.

Function Keys

The function keys (F1 ~ F12) are the 12 keys at the top of your keyboard.



Function keys let you enable or disable certain features of the computer. The functions can be performed by pressing the associated function keys.

Key Combination	Function
FN + F1	Enters "Lock computer mode". To restore your desktop, you need to log on again.
FN + F2	Switches between the power plans.
FN + F3	Switches the system to Sleep Mode.
FN + F4	Switches the system to Hibernation Mode.
FN + F5	Changes the active display device. To use a simultaneous mode, you must set the resolution of the internal display panel to match the resolution of the external display device.
FN + F6	Decreases the brightness of the display panel in individual steps.
FN + F7	Increases the brightness of the display panel in individual steps.
FN + F8	Turns the Airplane mode on or off.
FN + F9	Enables or disables the Touch Pad.

Key Combination	Function
FN + ESC	Turns the sound on or off.
FN + 1	Reduces the icon size on the desktop or the font sizes within one of the supported application windows.
FN + 2	Enlarges the icon size on the desktop or the font sizes within one of the supported application windows.
FN + 3	Decreases the playback volume of the computer.
FN + 4	Increases the playback volume of the computer.
FN + 5	Switches between available cooling methods for the current power plan. This function is supported with some models.
FN + Space	Changes the display resolution.
FN + S	Allows you to search your computer, the web, or within an app.
FN + Z ()	Toggles the mode of the keyboard backlight between Timer , On , and Off . To set up the brightness, Start -> TOSHIBA -> TOSHIBA Settings . Click Keyboard tab, and select a level under Keyboard Backlight Brightness Control . To set up the timer, launch the BIOS setup utility, select PowerManagement -> Keyboard Backlight Control Mode , and select TIMER . Adjust the timer under Backlight Lighting Time . This function is supported with some models.



Some functions show the toast notification at the edges of the screen. Those toast notifications are enabled by default. You can disable them in the TOSHIBA settings.

*To access it, click **Start -> TOSHIBA -> TOSHIBA Settings -> Keyboard**.*

Windows special keys

The keyboard provides two keys that have special functions in Windows, the Windows® logo key activates the **Start menu** while the application key has the same function as the secondary (right) mouse button.



This key activates the Windows **Start menu**.



This key has the same function as the secondary (right) mouse button.

Optical disc drive

Some models will be installed with a DVD Super Multi drive.

Formats

The drive supports the following formats: CD-ROM, DVD-ROM, DVD-Video, CD-DA, CD-Text, Photo CD™ (single/multi-session), CD-ROM Mode 1/Mode 2, CD-ROM XA Mode 2 (Form1, Form2), Enhanced CD (CD-EXTRA), Addressing Method 2, DVD-R, DVD-RW, DVD+R, DVD+RW, DVD-RAM, DVD-R DL (Format1), DVD+R DL.



Some types and formats of DVD-R DL and DVD+R DL discs might be unreadable.

Using the optical disc drive

The full-size drive provides high-performance execution of disc based programs. You can run either 12 cm (4.72") or 8 cm (3.15") discs without an adaptor.

For precautions on writing to discs, refer to the [Writing discs](#) section.

To load discs, do the following:

1. When the computer's power is on, press the eject button to open the disc tray slightly.
2. Grasp the disc tray gently and pull until it is fully opened.

Figure 4-2 Pressing the eject button and pulling the disc tray open

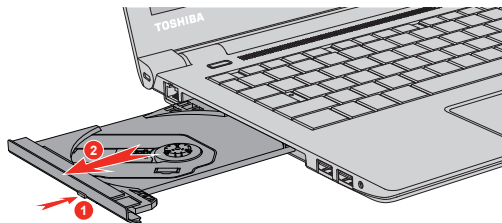

1. Eject button

3. Lay the disc, label side up, in the disc tray.

Figure 4-3 Inserting a disc

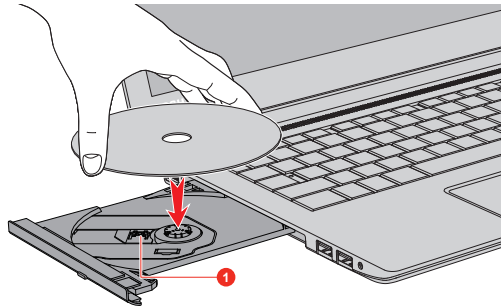

1. Laser lens



When the disc tray is fully opened, the edge of the computer covers the disc tray slightly. Therefore, you must to turn the disc at an angle when you place it in the disc tray. After seating the disc, however, make sure it lies flat.



- *Do not touch the laser lens or any portion of its surrounding casing as this might cause misalignment.*
- *Prevent foreign objects from entering the drive. Check the surface of the disc tray, especially the area behind the front edge of the disc tray, to make sure there are no such objects before closing the drive.*

4. Press gently at the center of the disc until you feel it click into place. The disc should lie below the top of the spindle, flush with the spindle base.
5. Push the center of the disc tray to close it. Press gently until it locks into place.



If the disc is not seated properly when the disc tray is closed, the disc might be damaged. Also, the disc tray might not open fully when you press the eject button.

Removing discs

To remove the disc, do the following:



Do not press the eject button while the computer is accessing the optical disc drive. Wait for the optical disc drive indicator to go out before you open the disc tray. Also, if the disc is spinning when you open the disc tray, wait for it to stop before you remove it.

1. To pop the disc tray partially open, press the eject button. Gently pull the disc tray out until it is fully opened.



When the disc tray pops open slightly, wait a moment to make sure the disc has stopped spinning before pulling the disc tray fully open.

2. The disc extends slightly over the sides of the disc tray so you can grasp it. Gently lift out the disc.
3. Push the center of the disc tray to close it. Press gently until it locks into place.

How to remove disc when the disc tray will not open

Pressing the eject button will not open the disc tray when the computer power is off. If the power is off, you can open the disc tray by inserting a slender object (about 20 mm) such as a straightened paper clip into the manual eject hole near the eject button.

Figure 4-4 Manual release with the eject hole

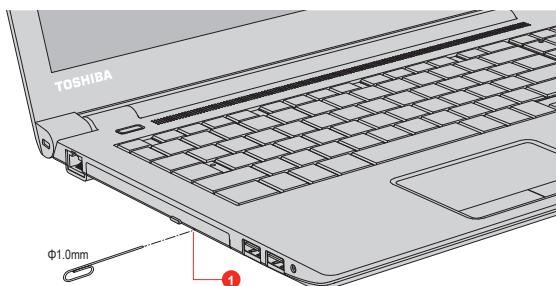

1. Manual eject hole



Turn off the power before you use the manual eject hole. If the disc is spinning when you open the disc tray, the disc might fly off the spindle and cause injury.

Writable discs

This section describes the types of writable discs. Check the specifications of your drive to see the types of discs it can write.

CDs

- CD-R discs can be written only once. The recorded data cannot be erased or changed.
- CD-RW discs including multi speed CD-RW discs, high-speed CD-RW discs and ultra-speed CD-RW discs can be recorded more than once.

DVDs

- DVD-R, DVD+R, DVD-R DL and DVD+R DL discs can be written only once. The recorded data cannot be erased or changed.

- DVD-RW, DVD+RW and DVD-RAM discs can be recorded more than once.

Writing discs

You can use the DVD Super Multi drive to write data to either CD-R, CD-RW, DVD-R, DVD-R DL, DVD-RW, DVD+R, DVD+R DL, DVD+RW or DVD-RAM discs.



When writing information to media using an optical drive, you should always ensure that you connect the AC adaptor to a live electrical outlet. It is possible that, if data is written while powered by the battery pack, the write process might sometimes fail due to low battery power. In these instances, data loss might occur.

Important message

Before you write or rewrite to any of the media supported by the optical disc drive, read and follow all of the setup and operating instructions in this section. If you fail to do so, you might find that the optical disc drive might not function properly, and you might fail to write or rewrite information successfully. This might cause you to either lose data or incur other damage to the drive or media.

Disclaimer

TOSHIBA does not assume responsibility for the following:

- Damage to any disc that might be caused by writing or rewriting with this product.
- Any change or loss of the recorded contents of media that might be caused by writing or rewriting with this product, or for any business profit loss or business interruption that might be caused by the change or loss of the recorded contents.
- Damage that might be caused by using third party equipment or software.

Given the technological limitations of current optical disc writing drives, you might experience unexpected writing or rewriting errors due to disc quality or problems with hardware devices. In view of this, it is good practice to make two or more copies of important data, in case of any undesired change or loss of the recorded contents.

Before writing or rewriting

- Based on TOSHIBA limited compatibility testing, we suggest the following manufacturers of disc media, however, it must be noted that disc quality can affect write or rewrite success rates. Also be aware that in no event does TOSHIBA guarantee the operation, quality or performance of any disc.

CD-R:

MITSUBISHI KAGAKU MEDIA CO., LTD.

CD-RW: (Multi-Speed, High-Speed and Ultra-Speed)

MITSUBISHI KAGAKU MEDIA CO., LTD.

DVD-R:**DVD Specifications for Recordable Disc for General Version 2.0**

MITSUBISHI KAGAKU MEDIA CO., LTD. (for 8x and 16x speed media)

DVD-R DL:

MITSUBISHI KAGAKU MEDIA CO., LTD. (for 4x and 8x speed media)

DVD+R:

MITSUBISHI KAGAKU MEDIA CO., LTD. (for 8x and 16x speed media)

DVD+R DL:

MITSUBISHI KAGAKU MEDIA CO., LTD. (for 8x speed media)

DVD-RW:**DVD Specifications for Recordable Disc for Version 1.1 or version 1.2**

MITSUBISHI KAGAKU MEDIA CO., LTD. (for 4x and 6x speed media)

DVD+RW:

MITSUBISHI KAGAKU MEDIA CO., LTD. (for 4x and 8x speed media)

DVD-RAM: (DVD Super Multi drive only)**DVD Specifications for DVD-RAM Disc for Version 2.0, Version 2.1 or Version 2.2**

Panasonic Corporation (for 3x and 5x speed media)



- *Some types and formats of DVD-R DL and DVD+R DL discs might be unreadable.*
- *Disc created in DVD-R DL format4 (Layer Jump Recording) cannot be read.*

When writing or rewriting

Observe the following points while you write or rewrite data to a media:

- Always copy data from the internal storage drive to the optical media. Do not use the cut-and-paste function as the original data will be lost if there is a write error.

Do not perform any of the following actions:

- Change users in the Operating Systems.
- Operate the computer for any other function, including such tasks as using a mouse or Touch Pad, or closing/opening the display panel.
- Start a communication application.
- Apply impact or vibration to the computer.
- Install, remove or connect external devices, including such items as a memory media card, USB device, external monitor or an optical digital device.
- Use the audio/video control button to reproduce music or voice.
- Open the optical disc drive.
- Do not use shut down, log off, Sleep Mode or Hibernation Mode functions while writing or rewriting.
- Make sure that the write/rewrite operation is completed before going into either Sleep Mode or Hibernation Mode (You can remove an optical media on the optical disc drive after writing is completed).
- If the media is of poor quality, or is dirty or damaged, writing or rewriting errors might occur.
- Set the computer on a level surface and avoid places subject to vibration such as airplanes, trains or cars. In addition, do not use the computer on an unstable surface such as a stand.
- Keep mobile phones and other wireless communication devices away from the computer.

CyberLink PowerDVD 14 DVD for TOSHIBA

Be aware of the following limitations when you use the CyberLink PowerDVD 14 DVD for TOSHIBA:

Notes on use

- This software can only be used on Windows operating system.
- CyberLink PowerDVD 14 DVD for TOSHIBA is only provided with models configured with a DVD Super Multi drive.
- CyberLink PowerDVD 14 DVD for TOSHIBA software is supported for playback of DVD and video file.
- Frame dropping, audio skipping or out of sync audio and video may occur during playback of some video titles.
- Close all other applications when using the CyberLink PowerDVD 14 DVD for TOSHIBA. Do not open any other applications or carry out any other operations during video playback. Playback may stop or not function properly in some situations.
- Unfinalized DVDs created on home DVD recorders may not be playable on the computer.
- Use DVD-Video discs with a region code which is either "the same as the factory default setting" (if applicable) or "ALL".

-
- Do not playback video while watching or recording television programs using other applications. Doing so may cause video playback or television program recording errors. In addition, if prescheduled recording starts during video playback it may cause video playback or television program recording errors. Please view video during times when there is no recording prescheduled.
 - The resume function cannot be used with some discs on the CyberLink PowerDVD 14 DVD for TOSHIBA.
 - It is recommended the AC adaptor be connected when playing video. Power saving features may interfere with smooth playback. When playing video using battery power, set the Power Options to "Balance".
 - The screen saver is disabled during video playback using the CyberLink PowerDVD 14 DVD for TOSHIBA. The computer will not automatically go into Hibernation or Sleep mode.
 - Do not configure the Display automatic power off function to run while the CyberLink PowerDVD 14 DVD for TOSHIBA is running.
 - Do not switch to Hibernation or Sleep Mode when running the CyberLink PowerDVD 14 DVD for TOSHIBA.
 - Do not lock the computer using the Windows logo () + L keys when running the CyberLink PowerDVD 14 DVD for TOSHIBA.
 - The CyberLink PowerDVD 14 DVD for TOSHIBA does not have a parental control function.
 - Carry out the installation/uninstallation of the CyberLink PowerDVD 14 DVD for TOSHIBA under a user account with administrator rights.
 - Do not change Windows Users while CyberLink PowerDVD 14 DVD for TOSHIBA is running.
 - For some DVD or video files, using the control window to change the audio track will also change the subtitle track.
 - The playback of some media files may not be normal by this player. This may also happen when using Windows Media Player and Video app.
 - When a DVD-Video disc is set in the DVD drive (for models with DVD drive), CyberLink PowerDVD 14 DVD for TOSHIBA will not start automatically.

Display Devices & Audio

- If the video image is not displayed on an external display or television, stop the CyberLink PowerDVD 14 DVD for TOSHIBA, and change the screen resolution. To change the screen resolution, click **Start** ->  (**Settings**) -> **System** -> **Display** -> **Resolution**. However, video cannot be output to some external displays and televisions due to output or playback conditions.
- When viewing video on an external display or TV, change the display device before playing. Video can be played only on internal LCD displays or external displays. In Clone mode (Dual View), CyberLink PowerDVD 14 DVD for TOSHIBA may not function properly.

-
- Do not change the screen resolution while running the CyberLink PowerDVD 14 DVD for TOSHIBA.
 - Do not change the display device while running the CyberLink PowerDVD 14 DVD for TOSHIBA.

Starting CyberLink PowerDVD 14 DVD for TOSHIBA

To start CyberLink PowerDVD 14 DVD for TOSHIBA, click **Start -> CyberLink PowerDVD 14 DVD for TOSHIBA**.

Operating CyberLink PowerDVD 14 DVD for TOSHIBA

Notes on Using CyberLink PowerDVD 14 DVD for TOSHIBA.

- Screen display and available features may vary amongst videos and scenes.

Open CyberLink PowerDVD 14 DVD for TOSHIBA Manual

CyberLink PowerDVD 14 DVD for TOSHIBA features and instructions are detailed in CyberLink PowerDVD 14 DVD for TOSHIBA Help. Use the following procedure to open CyberLink PowerDVD 14 DVD for TOSHIBA Help.

Press the **F1** key when CyberLink PowerDVD 14 DVD for TOSHIBA is launched.

Using the AccuPoint

To use the AccuPoint, simply push it with your finger tip in the direction you want to move the on-screen pointer.

The control buttons below the AccuPoint are used like the buttons on a standard mouse. Press the left button to select a menu item or to manipulate text or graphics designated by the pointer, and press the right button to display a menu or other function depending on the software you are using.

Some models are equipped with an AccuPoint.

AccuPoint precautions

Certain conditions can affect the on-screen pointer when using AccuPoint. For example, the pointer might travel contrary to AccuPoint operation or an error message might appear, if

- You touch the AccuPoint during power-up.
- You apply constant, soft pressure during power-up.
- There is a sudden temperature change.
- Strong stress is applied to the AccuPoint.

If an error message appears, reboot the computer. If an error message does not appear, wait a moment for the pointer to stop, then continue operation.

Replacing the cap

The AccuPoint cap is an expendable item that should be replaced after prolonged use.

1. To remove the AccuPoint cap, gently dig the cap out (with finger).

Figure 4-5 Removing the AccuPoint cap

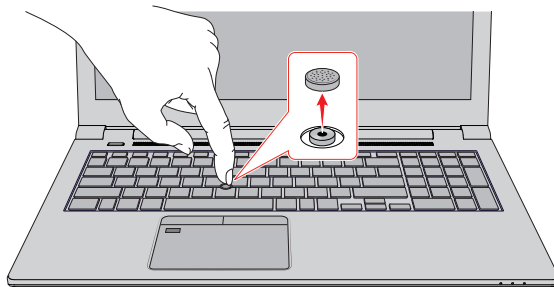

1. AccuPoint cap

Product appearance depends on the model you purchased.

2. Position a new cap on the peg. Be careful to let the peg inserted into the round groove inside the new cap and then press it into place.



- You can buy replacement AccuPoint caps from your TOSHIBA authorized dealer.
- AccuPoint cap is a removable part. Always use the AccuPoint with reasonable care.

Using the Fingerprint Sensor

Some models are equipped with the fingerprint sensor for the purpose of enrolling and recognizing fingerprints. Lightly touch and rest your finger on the fingerprint sensor to recognize fingerprints. During enrollment, you might need to touch and lift your finger on the sensor repeatedly until setup is complete. Follow the on-screen instructions to finish the setup.

By enrolling the ID and password onto the fingerprint authentication feature, it is no longer necessary to input the password from the keyboard. Fingerprint feature enables you to:

- Sign-in to Windows
- Unlock the password-protected screen-saver.
- Authentication of the User Password (and, if applicable, the HDD/SSD Password) when booting up the computer (Pre-Boot authentication).
- Single Sign-On feature

Figure 4-6 Using the Fingerprint Sensor

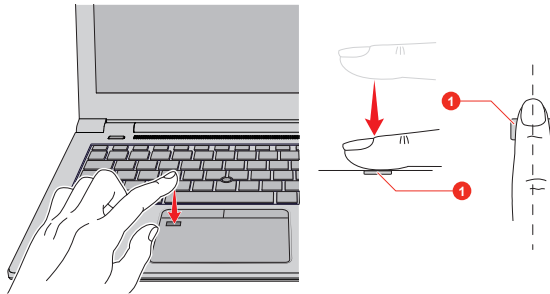

1. Fingerprint sensor



- *Fingerprint cannot be used in models that do not have a fingerprint function.*
- *Total fingerprints which can be registered are 20 pcs.*

Points to note about the Fingerprint Sensor

Be aware of the following considerations when using the fingerprint sensor. A failure to follow these guidelines might result in damage to the sensor, sensor failure, fingerprint recognition problems or a lower fingerprint recognition success rate.

- Do not scratch or poke the sensor with your nails or any hard or sharp objects.
- Do not press the sensor strongly.
- Do not touch the sensor with a wet finger or any wet objects. Keep the sensor surface dry and free from water vapor.
- Do not touch the sensor with a soiled or dirty finger as minute foreign particles of dust and dirt might scratch it.
- Do not paste stickers or write on the sensor.
- Do not touch the sensor with a finger or any other object which might have a build-up of static electricity on it.

Observe the following before you place your finger on the sensor whether for fingerprint enrollment/registration or recognition.

- Wash and dry your hands thoroughly.
- Remove static electricity from your fingers by touching any metal surface. Static electricity is a common cause of sensor failures, especially when the weather is dry.
- Clean the sensor with a lint-free cloth. Do not use detergent or any other chemicals to clean the sensor.

Avoid the following finger conditions for enrollment or recognition as they might result in fingerprint enrollment errors or a drop in the fingerprint recognition success rate

- Soaked or swollen finger, for example as might occur after taking a bath.
- Injured finger
- Wet finger
- Soiled or oily finger
- Extremely dry skin condition on finger

Observe the following to improve the fingerprint recognition success rate.

- Enroll two or more fingers.
- Enroll additional fingers if a recognition failure often occurs when using already enrolled fingers.
- Check the condition of your finger. Any conditions which have changed since enrollment, such as injury, rough skin, and extremely dry, wet, soiled, dirty, oily, soaked or swollen fingers, might lower the recognition success rate. Also if the fingerprint is worn down or the finger becomes thinner or fatter, the recognition success rate might be lowered.
- As the fingerprint for each finger is different and unique you should ensure that only the registered or enrolled fingerprint or fingerprints are used for identification.
- The fingerprint sensor compares and analyzes the unique characteristics in a fingerprint. However, there might be instances where certain users are unable to register their fingerprints due to insufficient unique characteristics in their fingerprints.
- The recognition success rate might differ from user to user.

Battery

This section explains battery types, use, recharging methods and handling.

Battery types

The computer has different types of batteries.

Battery pack

When the AC adaptor is not connected, the main power source of the computer is a removable lithium ion battery pack, also referred to in this manual as the main battery. You can purchase additional battery packs for extended use of the computer away from an AC power source although you should not change the battery pack while the AC adaptor is connected.

Before you remove the battery pack, save your data and shut down the computer, or place the computer into Hibernation Mode. Be aware that, when placing the computer into Hibernation Mode, the contents of memory are saved to the internal storage drive, although for safety sake, it is best to also save your data manually.

Real-Time Clock (RTC) battery

The Real-Time Clock (RTC) battery provides power for the internal real-time clock and calendar function and also maintains the system configuration while the computer is turned off. If the RTC battery becomes completely discharged, the system will lose this information and the real-time clock and calendar will stop working.

You can change the Real-Time Clock settings in the TOSHIBA Setup Utility. Refer to [Real Time Clock](#) for further information.



The RTC battery of the computer must be replaced only by your dealer or by a TOSHIBA service representative. The battery can explode if not properly replaced, used, handled, or disposed of. Dispose of the battery as required by local ordinances or regulations.

Care and use of the battery pack

This section provides the important safety precautions in order to handle your battery pack properly.

Refer to the enclosed **Instruction Manual for Safety and Comfort** for detailed precautions and handling instructions.



- *Make sure the battery is securely installed in the computer before attempting to charge the battery pack. Improper installation might generate smoke or fire, or cause the battery pack to rupture.*
- *Keep the battery pack out of reach of infants and children. It can cause injury.*



- *The battery pack can explode if not replaced, used, handled or disposed of properly. Dispose of the battery as required by local ordinances or regulations. Use only batteries recommended by TOSHIBA as replacements.*
- *Charge the battery pack only in an ambient temperature from 5 through 35 degrees Celsius. Otherwise, the electrolyte solution might leak, battery pack performance might deteriorate, and the battery life might be shortened.*
- *Never install or remove the battery pack without first turning off the power and disconnecting the AC adaptor. Never remove the battery pack while the computer is in Sleep Mode, as data might be lost.*



Never remove the battery pack while the Wake-up on LAN function is enabled, as data will be lost. Before you remove a battery pack, disable the Wake-up on LAN function.

Charging the batteries

When the power in the battery pack becomes low, the **DC IN/Battery** indicator flashes amber to indicate that only a few minutes of battery power remain. If you continue to use the computer while the **DC IN/Battery** indicator flashes, the computer enters Hibernation Mode so that you do not lose any data, and automatically turn itself off.

You must recharge the battery pack when it becomes discharged.

Procedures

To recharge a battery pack, connect the AC adaptor to the DC IN 19V jack and plug the other end into a working outlet. The **DC IN/Battery** indicator glows amber while the battery is being charged.

Charging Time

The following table shows the approximate time required to charge an exhausted battery fully.

Battery type	Power off	Power on
Battery pack (45 Wh, 4 cell)	about 3.5 hours	about 3 ~ 10 hours
RTC battery	Does not charge	Does not charge



Be aware that the charging time when the computer is on is affected by ambient temperature, the temperature of the computer and how you are using the computer. If you make heavy use of external devices for example, the battery might scarcely charge at all during operation.

Charging notice

The battery might not begin charging immediately under the following conditions:

- The battery is extremely hot or cold (if the battery is extremely hot, it might not charge at all). To ensure the battery charges to its full capacity, charge it at room temperature of between 5°C to 35°C (41–95°F).
- The battery is nearly completely discharged. In this instance, leave the AC adaptor connected for a few minutes and the battery should begin charging.

The **DC IN/Battery** indicator might show a rapid decrease in battery operating time when you try to charge a battery under the following conditions:

- The battery has not been used for a long time.

- The battery has completely discharged and been left in the computer for a long time.

In such cases, do the following:

1. Fully discharge the battery by leaving it in the computer with the power on until the system automatically turns itself off.
2. Connect the AC adaptor to the DC IN 19V jack of the computer, and to a wall outlet that is supplying power.
3. Charge the battery until the **DC IN/Battery** indicator glows white.

Repeat these steps two or three times until the battery recovers normal capacity.

Monitoring battery capacity

Remaining battery power can be monitored using the following methods.

- Clicking the battery icon on the Windows Taskbar
- Via the Battery Status in the Windows Mobility Center window



- *Wait several seconds to monitor the remaining operating time because the computer needs time to check the remaining capacity of the battery pack and then calculate the remaining operating time, based on this together with the current power consumption.*
- *Be aware that the actual remaining operating time might differ slightly from the calculated time.*
- *With repeated discharges and recharges, the battery capacity will gradually decrease. In view of this, it is noted that an often used, older battery will not operate for as long as a new battery even when both are fully charged.*

Maximizing battery operating time

The usefulness of a battery depends on how long it can supply power on a single charge, while how long the charge lasts in a battery depends on:

- Processor speed
- Screen brightness
- Internal storage drive power off period
- How often and for how long you use the internal storage drive and external disk drives, for example, optical disc
- How much charge the battery contained to begin with
- How you use optional devices, such as a USB device, to which the battery supplies power
- Where you store your programs and data
- Whether you close the display panel when you are not using the keyboard - closing the display saves power
- The environmental temperature - operating time decreases at low temperatures

- System Sleep Mode
- System Hibernation Mode
- Display power off period
- Whether you enable Sleep Mode, which can conserve battery power if you are frequently turning the computer off and on
- The condition of the battery terminals. Always ensure the terminals stay clean by wiping them with a clean dry cloth before installing the battery pack

Batteries exhausted time

When you turn off the power of your computer with batteries fully charged, the batteries exhaust within the following approximate period.

Battery type	Sleep Mode	Shut Down Mode
Battery pack (45 Wh, 4 cell)	about 6 days	about 100 days
RTC battery	about 7 years	about 7 years

Extending battery life

To maximize the life of your battery packs, do the following at least once a month.

1. Turn off the computer's power.
2. Disconnect the AC adaptor and turn on the computer's power. If it does not turn on then go to Step 4.
3. Operate the computer on battery power for five minutes. If you find that the battery pack has at least five minutes of operating time, continue operating until the battery pack is fully discharged. However, if the **DC IN/Battery** indicator flashes or there is some other warning to indicate a low battery condition, go to Step 4.
4. Connect the AC adaptor to the DC IN 19V jack of the computer, and to a wall outlet that is supplying power. The **DC IN/Battery** indicator glows amber to indicate that the battery pack is being charged. However, if **DC IN/Battery** indicator does not glow, this indicates that power is not being supplied. Check the connections for the AC adaptor and the power cord.
5. Charge the battery pack until the **DC IN/Battery** indicator glows white.

Replacing the battery pack

Be aware that the battery pack is classified as a consumable item.

The operating life of the battery pack will gradually reduce through repeated charging and discharging, and should be replaced when it reaches the end of its operating life. In addition to this, you might also replace a discharged battery pack with a charged spare when you are

operating your computer away from an AC power source for an extended period of time.

This section explains how to remove and install the battery pack, and begins with the removal process which is detailed through the following steps.



- *Do not remove the battery pack while the computer is in Sleep Mode, as data is stored in RAM, so if the computer loses power it might be lost.*
- *In Hibernation Mode, data will be lost if you remove the battery pack or disconnect the AC adaptor before the save is completed.*
- *Do not touch the battery release latch while holding the computer or the battery pack might fall out due to the unintentional release of the battery release latch and cause injuries.*

Removing the battery pack

To remove a discharged battery, do the following:



1. Save your work.
2. Click **Start** ->  (**Power**) and then click **Shut down** while holding down the **SHIFT** key. Ensure that the **Power** indicator is off.
3. Remove all cables and peripherals that are connected to the computer.
4. Close the display panel and turn the computer upside down.
5. Slide the battery lock into its unlocked () position.
6. Slide and hold the battery release latch to disengage the battery pack and then lift it up to remove it from the computer.

Figure 4-7 Releasing the battery pack



1. Battery lock
2. Battery release latch

3. Battery pack

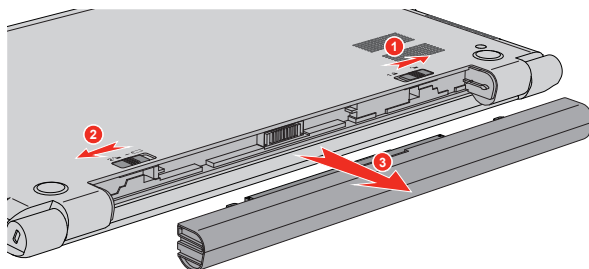
Installing the battery pack

To install a battery pack, do the following:



Do not touch the battery release latch while holding the computer or the battery pack might fall out due to the unintentional release of the battery release latch and cause injuries.

1. Insert the battery pack as far as it will go into the computer.
2. Ensure that the battery pack is securely in place and the battery lock is in its locked (🔒) position.
3. Turn your computer over.

Wireless WAN Device

Some models are equipped with the Wireless WAN device. This device gives you the ability for a high-speed connection to the Internet, corporate intranet, and your email while you are away from the office.

Installing a SIM card

To install a SIM card, do the following:

1. Click **Start** ->  (**Power**) and then click **Shut down** and ensure that the **Power** indicator is off.
2. Remove the AC adaptor and all cables and peripherals connected to the computer.
3. Close the display panel.
4. Turn the computer upside down and remove the battery pack.
5. Turn your computer over and then locate the SIM card slot.

- To pop the SIM card tray partially open, insert a slender object (about 10mm, diameter 0.8mm), such as a straightened paper clip, into the eject hole. Gently pull to open the SIM card tray.



Never pull the SIM card tray completely out of the slot.

Figure 4-8 Open the SIM card tray with the eject hole

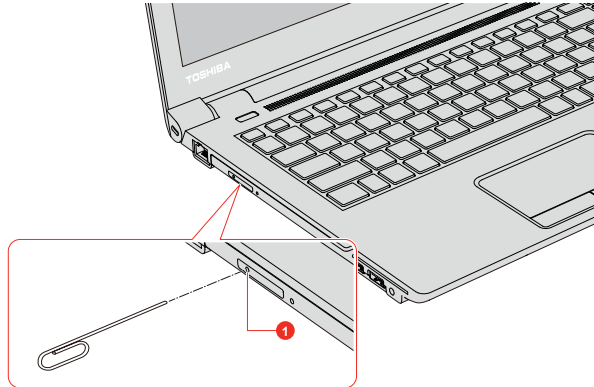

1. Eject hole

- Place the SIM card into the SIM card tray with the metal connectors facing up.
- Insert the SIM card tray into the SIM card slot, and push the center of the tray to close it. Press gently until it locks into place.
- Install the battery pack.

Figure 4-9 Installing the SIM Card

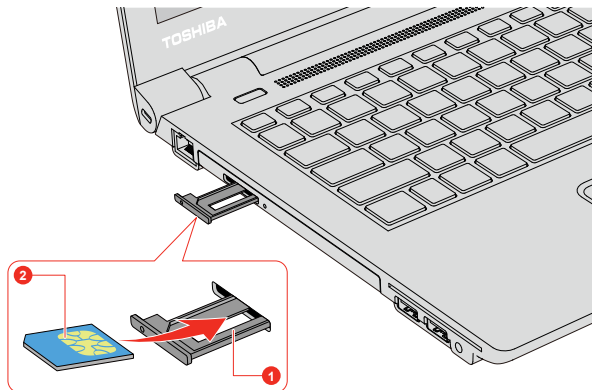

1. SIM card tray

2. SIM card



- *Never allow metal objects, such as screws, staples and paper clips, to enter the computer. Foreign metal objects can create a short circuit, which can cause computer damage and fire, possibly resulting in serious injury.*
- *Do not touch the connectors on the SIM card or on the computer. Debris on the connectors might cause access problems.*

Removing a SIM Card

To remove the SIM card, do the following:

1. Shut down the computer. Make sure the **Power** indicator is off.
2. Close the display panel.
3. Turn the computer upside down and remove the battery pack.
4. To pop the SIM card tray partially open, insert a slender object (about 10mm, diameter 0.8mm), such as a straightened paper clip, into the eject hole. Gently pull to open the SIM card tray.
5. Remove the SIM card from the SIM card tray.
6. Insert the SIM card tray back into the SIM card slot.

GPS Function

Your computer might include a built-in GPS (Global Positioning System).

The performance of GPS varies depending on the environment. Failure to pinpoint a location might happen.

Your current location might not be shown depending on the status of GPS or the location. If you are obtaining your current location information from the computer, your current location might not be detected due to the information accuracy. Specifically, your current location might not be detected in the following places or situations:

- Inside or directly under a building
- Inside a bag or box
- Among dense trees
- When there is an obstacle (person or object) in the front of the antenna
- Underground tunnel, underground, or underwater
- Buildings, streets or residential areas
- Near to high voltage cables
- Bad weather, such as heavy rain or snow

Additional memory module

This section is only applicable for models equipped with the memory module cover.

You can install additional memory into the computer in order to increase the amount of system memory that is available. This section describes how to install and remove optional memory modules.



- You should place a mat beneath the computer in order to prevent the computer's lid from scratches or damages when you are installing/replacing the memory module. In this instance, you should avoid mats that are made of materials that hold or generate static electricity.
- When installing or removing a memory module, you must ensure that you do not touch any other internal areas of the computer.



- Use only memory modules approved by TOSHIBA.
- Do not try to install or remove a memory module under the following conditions.
 - a. The computer is turned on.
 - b. The computer was shut down in either Sleep or Hibernation Mode.
 - c. Wake-up on LAN is enabled.
 - d. The wireless communication function is on.
 - e. Sleep and Charge function is enabled.
- Be careful not to let screws or other foreign matter fall into the computer. It might cause malfunction or electric shock.
- Additional memory module is a precision electronic component that might be fatally damaged by static electricity. Since the human body can carry static electricity, it is important that you discharge yourself before touching or installing any additional memory modules. To discharge your body's static electricity, simply touch any metal close to you with bare hands.



Use a point size 0 Phillips screwdriver to remove and fasten the screws. The use of an incorrect screwdriver can damage the screw heads.

Installing a memory module

To install a memory module, do the following:

1. Click **Start** ->  (**Power**) and then click **Shut down** while holding down the **SHIFT** key. Ensure that the **Power** indicator is off.
2. Remove the AC adaptor, all cables, and peripherals connected to the computer.
3. Close the display panel.
4. Turn the computer upside down and remove the battery pack.
5. Loosen the screw securing the memory module cover in place. Note that the screw is attached to the cover in order to prevent it from being lost.

-
- Slide your fingernail or a thin object under the cover and lift it off.

Figure 4-10 Removing the memory module cover

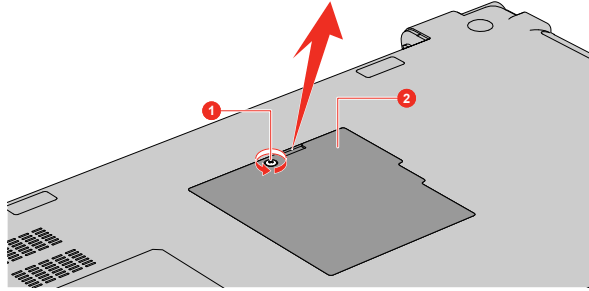

1. Screw

2. Memory module cover

7. Align the notch of the memory module with that of the memory slot and gently insert the module into the slot at about a 30 degree angle before holding it down until the latches on either side snap into place.

Figure 4-11 Seating the memory module

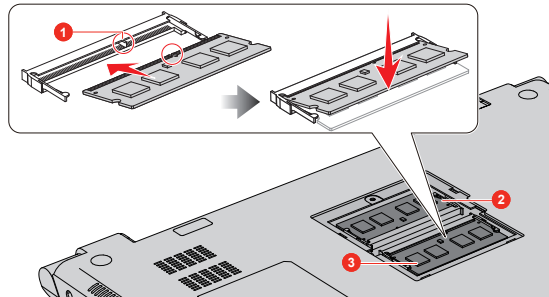

1. Notch
2. Slot A

3. Slot B



- *Never allow metal objects, such as screws, staples and paper clips, to enter the computer. Foreign metal objects can create a short circuit, which can cause computer damage and fire, possibly resulting in serious injury.*
- *Do not touch the connectors on the memory module or on the computer. Debris on the connectors might cause memory access problems.*



- *The slot A is reserved for the first memory module. Use the slot B for expanded memory. If only one module is installed, use the slot A.*
- *Align the grooves along the edges of the memory module with the locking tabs on the connector and insert the module into the connector firmly. If you find it difficult to install the memory module, gently prise the locking tabs outwards using the tip of your finger.*
- *Also ensure that you hold the memory module along its left and right hand edges - the edges with the grooves in.*

8. Seat the memory module cover in place and secure it with the screw.



Ensure that the memory module cover is firmly closed.

Figure 4-12 Seating the memory module cover

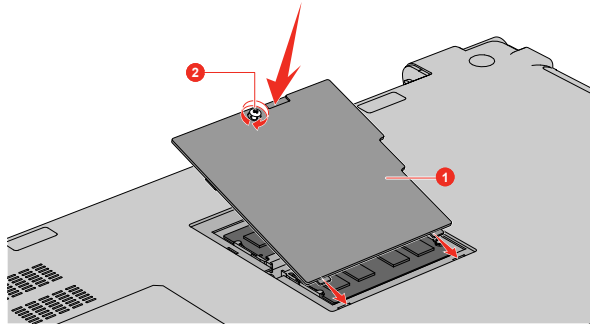

1. Memory module cover

2. Screw

9. Install the battery pack.
10. Turn your computer over.
11. Connect the AC adaptor and turn on the computer. Make sure that the added memory is recognized. To confirmed it, click **Start -> Windows System -> Control Panel -> System and Security -> System**.

Removing a memory module

To remove the memory module, do the following:

1. Click **Start -> (Power)** and then click **Shut down** while holding down the **SHIFT** key. Ensure that the **Power** indicator is off.
2. Remove the AC adaptor, all cables, and peripherals connected to the computer.
3. Close the display panel.
4. Turn the computer upside down and remove the battery pack.
5. Loosen the screw securing the memory module cover in place. Note that the screw is attached to the cover in order to prevent it from being lost.
6. Slide your fingernail or a thin object under the cover and lift it off.
7. Push the latches away from the module in order to release it. A spring forces one end of the module up at an angle.

8. Grasp the module by its edges and remove it from the computer.



- *If you use the computer for a long time, the memory modules and the circuits locating close to the memory modules will become hot. In this case, let them cool to room temperature before you replace them. Or you will get burnt if you touch any of them.*
- *Do not touch the connectors on the memory module or on the computer. Debris on the connectors might cause memory access problems.*

Figure 4-13 Removing the memory module

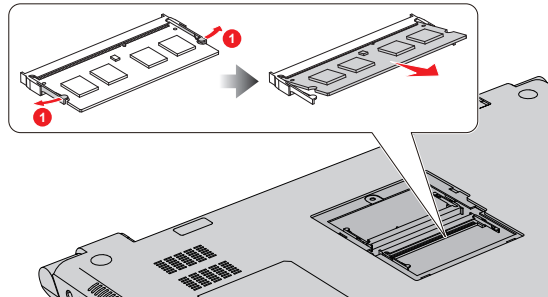

1. Latches

9. Seat the memory module cover in place and secure it with the screw.



Ensure that the memory module cover is firmly closed.

10. Install the battery pack.
11. Turn your computer over.
12. Connect the AC adaptor and turn the computer on.

LAN

The computer has built-in support for Ethernet LAN (10 megabits per second, 10BASE-T), Fast Ethernet LAN (100 megabits per second, 100BASE-TX) or Gigabit Ethernet LAN (1000 megabits per second, 1000BASE-T).

This section describes how to connect/disconnect to a LAN.



- *The Wake-up on LAN function consumes power even when the system is off. Leave the AC adaptor connected while using this feature.*
- *The Link speed (10/100/1000 megabits per second) changes automatically depending on the network conditions (connected device, cable or noise and so on).*

LAN cable types



The computer must be configured properly before connecting to a LAN. Logging onto a LAN using the computer's default settings might cause a malfunction in LAN operation. Check with your LAN administrator regarding set-up procedures.

If you are using Gigabit Ethernet LAN (1000 megabits per second, 1000BASE-T), be sure to connect with a CAT5e cable or higher. You cannot use a CAT3 or CAT5 cable.

If you are using Fast Ethernet LAN (100 megabits per second, 100BASE-TX), be sure to connect with a CAT5 cable or higher. You cannot use a CAT3 cable.

If you are using Ethernet LAN (10 megabits per second, 10BASE-T), you can connect with a CAT3 or higher cable.

Connecting the LAN cable

To connect the LAN cable, do the following:



- *Connect the AC adaptor before connecting the LAN cable. The AC adaptor must remain connected during LAN use. If you disconnect the AC Adaptor while the computer is accessing a LAN, the system might hang up.*
- *Do not connect any other cable to the LAN jack except the LAN cable. Otherwise, malfunctions or damage might occur.*
- *Do not connect any power supplying device to the LAN cable that is connected to the LAN jack. Otherwise, malfunctions or damage might occur.*

1. Turn off the power to all external devices connected to the computer.
2. Plug one end of the cable into the LAN jack. Press gently until you hear the latch click into place.

Figure 4-14 Connecting the LAN cable

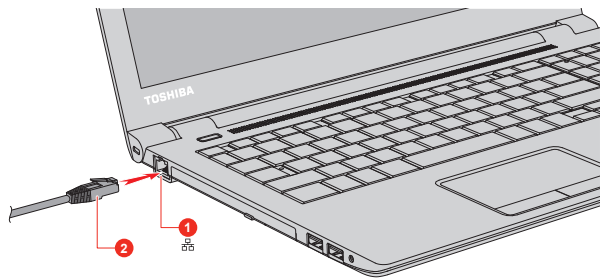

1. LAN jack

2. LAN cable

3. Plug the other end of the cable into a LAN hub connector or router. Check with your LAN administrator and hardware or software vendor before using or configuring a network connection.

Memory media

The computer is equipped with a memory media slot that can accommodate some kinds of memory media with various memory capacities so that you can easily transfer data from devices, such as digital cameras and Personal Digital Assistants.



Keep foreign objects out of the memory media slot. Never allow metal objects, such as screws, staples and paper clips, to enter the computer or Keyboard. Foreign metal objects can create a short circuit, which can cause computer damage and fire, possibly resulting in serious injury.



- An adaptor is required to use miniSD/microSD Card.
- Not all memory media have been tested and verified to work correctly. Therefore, it is not possible to guarantee that all memory media can operate properly.

Figure 4-15 Examples of memory media



Secure Digital (SD) Card

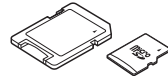

microSD card adaptor and
microSD card



MultiMediaCard (MMC)



Points to note about the memory media card

SD/SDHC/SDXC memory cards comply with SDMI (Secure Digital Music Initiative), which is a technology adopted to prevent unlawful copy or playback of digital music. For this reason, you cannot copy or play back protected material on another computer or other device, and you cannot reproduce any copyrighted material except for your personal enjoyment.

The following is a simple explanation for distinguishing SD memory cards from SDHC memory cards and SDXC memory cards.

- SD, SDHC and SDXC memory cards appear the same externally. However, the logo on memory cards is different, so pay careful attention to the logo when purchasing.



- The SD memory card logo is ().
 - The SDHC memory card logo is ().
 - The SDXC memory card logo is ().
- The maximum capacity of SD memory cards is 2 GB. The maximum capacity of SDHC memory cards is 32 GB. The maximum capacity of SDXC memory cards is 256 GB.

Memory media format

New media cards are formatted according to specific standards. If you wish to reformat a media card, be sure to do so with a device that uses media cards.

Formatting a memory media card

Memory media cards are sold already formatted in conformity to specific standards. If you reformat a memory card, be sure to reformat it with a device such as digital camera or digital audio player that uses the memory cards, not with the format command provided within Windows.



To format all areas of the memory card, including the protected area, you must obtain an appropriate application that applies the copy protection system.

Media care

Observe the following precautions when handling the card.

- Do not twist or bend cards.
- Do not expose cards to liquids or store in humid areas or lay media close to containers of liquid.
- Do not touch the metal part of a card or expose it to liquids or let it get dirty.
- After using card, return it to its case.
- The card is designed so that it can be inserted only one way. Do not try to force the card into the slot.
- Do not leave a card partially inserted in the slot. Press the card until you hear it click into place.
- Set the write-protect switch to the lock position, if you do not want to record data.
- Memory cards have a limited lifespan, so it is important to back up important data.
- Do not write to a card if the battery power is low. Low power might affect writing accuracy.
- Do not remove a card while read/write is in progress.



For more details on using memory cards, see manuals accompanying the cards.

About the write-protect feature

Memory media cards have a write-protect function.

- SD Card (SD memory card, SDHC memory card and SDXC memory card)



Set the write-protect switch to the lock position, if you do not want to record data.

Inserting memory media

The following instructions apply to all types of supported media devices. To insert memory media, do the following:

1. Turn the memory media so that the contacts (metal areas) face down.
2. Insert the memory media into the memory media slot on your computer.
3. Press the memory media gently until it clicks into place.

Figure 4-16 Inserting memory media

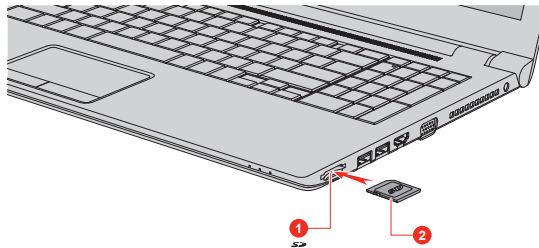

1. Memory media slot

2. Memory media



- Make sure that the memory media is oriented properly before you insert it. If you insert the media in wrong direction, you might not be able to remove it.
- When inserting the memory media, do not touch the metal contacts. You might expose the storage area to static electricity, which can destroy data.
- Do not turn off the computer or switch to Sleep Mode or Hibernation Mode while files are being copied. Failure to do so might cause data loss.

Removing memory media

The following instructions apply to all types of supported media devices. To remove memory media, do the following:

1. Click the **Safely Remove Hardware and Eject Media** icon on the Windows Taskbar.
2. Select the memory media that you want to remove.
3. Push the memory media until you hear a click to partially release it.
4. Grasp the media and remove it.



- *If you remove the memory media or turn off the power while the computer is accessing the memory media, you might lose data or damage the media.*
- *Do not remove the memory media while the computer is in Sleep or Hibernation Mode. The computer might become unstable or data in the memory media might be lost.*
- *Do not remove only the miniSD/microSD Card while leaving the adaptor in the memory media slot.*

Smart Card

A Smart Card is a credit card sized plastic card. An extremely thin integrated circuit (IC chip) is embedded into the card on which information can be recorded. These cards can be used for a wide variety of applications including telephone related and electronic monetary payments.

This section contains information on the proper use of the Smart Card slot, and it is strongly recommended that you read it before operating the computer.

Some models are equipped with a Smart Card slot.



Your computer supports ISO7816-3 asynchronous cards (support protocols are T=0 and T=1) with a working voltage of 5 V.

Inserting a Smart Card

The Smart Card slot is on the side of the computer. The Windows hot-install feature allows you to insert a Smart Card while the computer is turned on.

To install a Smart Card, do the following:

1. Insert the Smart Card into the Smart Card slot with the metal connectors facing up.

2. Press the Smart Card gently to ensure a firm connection is made. The computer will identify the Smart Card and display an icon in the Windows Taskbar.



- *When inserting a Smart Card into the Smart Card slot, make sure to confirm that the card is oriented correctly before inserting.*
- *Insert the Smart Card until it reaches the end of the Smart Card slot. The Smart Card is partially extended beyond the chassis edge. Do not attempt to insert it further.*
- *Always remove the Smart Card from the Smart Card slot before moving the computer.*
- *Remove the Smart Card after use.*

Failure to follow these instructions might result in damage to the computer and/or damage to the Smart Card.

3. After inserting the Smart Card, you should refer to its documentation and also check the configuration in Windows to ensure that it is correct.

Removing a Smart Card

To remove a Smart Card, do the following:

1. Click the **Safely Remove Hardware and Eject Media** icon on the Windows Taskbar.



- *Before removing the Smart Card, confirm that the Smart Card is not working with any program or system.*
- *Be careful not to bend the Smart Card while removing it from the computer.*

2. Point to **Smart Card** and click the left Touch Pad control button.
3. Grasp the Smart Card and remove it.

External Display

Your computer video capabilities can be enhanced with additional displays. External displays allow you to share your desktop or extend the desktop area.



As the port operation of all external monitors have not been confirmed, some display devices might not function properly.

Connecting an external display

Your computer comes with a built-in display, but you can also connect other external displays via available ports on the computer.

External RGB monitor port

An external analog monitor can be connected to the External RGB monitor port on the computer. To connect an external analog monitor, do the following:

1. Connect one end of the RGB cable to the External RGB monitor port.
2. Connect the other end of the RGB cable to the RGB port of the computer.



There are no fastening screws for an external monitor cable on the External RGB monitor port. However, external monitor cables which have connectors with fastening screws can still be used.

4. Turn the external monitor's power on.

Figure 4-17 Connecting the RGB cable to the External RGB monitor port



1. External RGB monitor port

2. RGB cable

When you turn on the power, the computer automatically recognizes the monitor and determines whether it is a color or monochrome device.

When displaying desktop on an external RGB monitor, desktop is sometimes displayed on the center of the monitor with black bars around desktop (with small size).

At that time, read the manual of the monitor and set the display mode which is supporting at the monitor. Then it will be displayed with suitable size with correct aspect ratio.

The HDMI™ out port

HDMI™ (High-Definition Multimedia Interface™) port digitally transfers both video and audio data without reducing the quality. HDMI™-compatible external display devices including televisions can be connected via the HDMI™ out port.

To connect an HDMI™-compatible display device, do the following:



To connect a device to the HDMI™ out port, you must purchase a suitable HDMI™ cable.

1. Plug one end of the HDMI™ cable into the HDMI™ in port of the HDMI™ display device.
2. Plug the other end of the HDMI™ cable into the HDMI™ out port on your computer.

3. Turn the HDMI™ display device's power on.

Figure 4-18 Connecting the HDMI™ out port

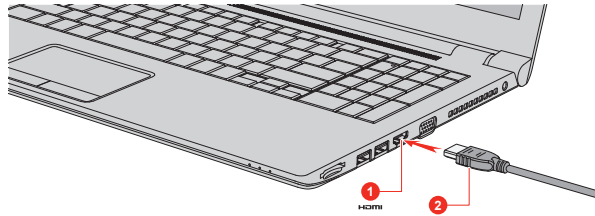

1. HDMI™ out port

2. HDMI™ cable



Do not plug/unplug an HDMI™ device under the following conditions:

- *The system is starting up.*
- *The system is shutting down.*

When you connect a television or external monitor to the HDMI™ port, the display output device is set to HDMI™.

When you unplug the HDMI™ cable and replug it, wait at least 5 seconds before you replug the HDMI™ cable again.

Settings for display video on HDMI™

To view video on the HDMI™ display device, be sure to configure the following settings otherwise you might find that nothing is displayed.



Be sure to use the function key to select the display device before starting to play video. Do not change the display device or audio device while playing video.

Do not change the display device under the following conditions.

- *While data is being read or written*
- *While communication is being carried out*

Wireless display

Your computer might support wireless display, a wireless technology which utilizes Wi-Fi® to allow the computer to be wirelessly connected to external displays including TVs as extended screens. With wireless display, documents, streamed/local media contents or other online contents can be shared wirelessly with others.

To use wireless display, either one of the following devices is required:

- A compatible external display with built-in support for wireless display.

- An external display with HDMI™ port and a wireless display adaptor.
The wireless display adaptor is a device that connects to the external display via HDMI™ port and can receive Wi-Fi® signals from your computer.

To wirelessly connect to an external display, you can follow the steps as described below:

1. Go to  (**Settings**) and click **Devices -> Bluetooth & other devices -> Add Bluetooth or other device**.
2. Click **Wireless display or dock**. Your computer starts searching for the wireless display device.
3. After the wireless display device is searched, follow the on-screen instructions to finish connection.

After the connection is established, the name of the wireless display device appears under **Projectors**.

To disconnect the Wireless display device, click the wireless display device name and then click **Remove device**.

Changing the external playback settings

After one or more external displays are connected, the operating system can automatically detect, identify, and set up the display settings.

You can also manually manage how the external displays work and change the display settings by pressing **P** while holding down the **Windows** () key. If you disconnect the external display before you turn off the computer's power, be sure to switch to the internal display.



When you change the display output device, the audio playback device might not switch automatically. In this case, in order to set the playback device to the same device as the display output device, adjust the audio playback device manually by the following steps:

1. Click **Start -> Windows System -> Control Panel -> Hardware and Sound -> Sound**.
2. In the **Playback** tab, select the playback device which you want to switch to.
3. To use the internal speakers on your computer, select **Speakers**. To use the television or the external monitor that you have connected to the computer, select a different playback device.
4. Click the **Set Default** button.
5. Click **OK** to close the **Sound** dialog.

TOSHIBA Hi-Speed Port Replicator III 180W/120W

In addition to the ports available on the computer, the TOSHIBA Hi-Speed Port Replicator III 180W/120W also provides several kinds of ports.

The Port Replicator connects directly to the docking interface on the underside of the computer. The AC adaptor connects the Port Replicator to a power source.



- You must connect the AC adaptor before you connect to a Port Replicator.
- The ports on the Port Replicator might have higher priority than the ports on the docked computer.
- When you use external display ports on the Port Replicator or on your computer, some software might show different type of ports which you connected.
- When connecting an AC Adaptor to the Port Replicator, use only the AC Adaptor included with Port Replicator. Do not use the computer's AC Adaptor.
- Refer to the Port Replicator's User's Manual for more details.

To dock your computer in the Port Replicator, do the following:

1. Align the top left and top right corner of your computer to the **C'** mark on the Port Replicator.
2. Press down on the back of the computer until it clicks into place. The computer connector on the port replicator engages the computer's docking port.

When the computer is connected, the Docked light on the Port Replicator glows green while the computer is powered on.

Figure 4-19 Aligning your computer with the Port Replicator

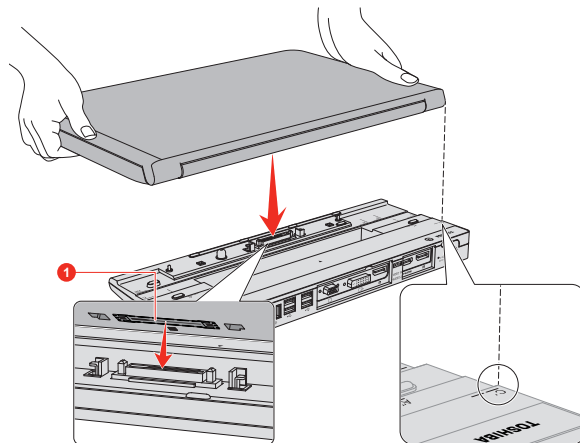

1. Docking port (computer)

Product appearance depends on the model you purchased.



Make sure the AC adaptor is always connected to the TOSHIBA Hi-Speed Port Replicator III 180W/120W while in use. Otherwise the Port Replicator will stop working, possibly resulting in data loss.

Some models support multiple display function if equipped with a TOSHIBA Hi-Speed Port Replicator III 180W/120W.



The port replicator supports a maximum of two external displays. For each VIDEO panel, only one port can function at a time.

Security lock

A security lock enables you to anchor your computer to a desk or other heavy object in order to help prevent unauthorized removal or theft. The computer has a security lock slot into which you can attach one end of the security cable, while the other end attaches to a desk or similar object. The methods used for attaching security cables differ from product to product. Refer to the instructions for the product you are using for more information.

Connecting the security lock

To connect a security cable to the computer, do the following:

1. Turn the computer so the security lock slot faces you.
2. Align the security cable with the lock slot and secure it in place.

Figure 4-20 Security lock

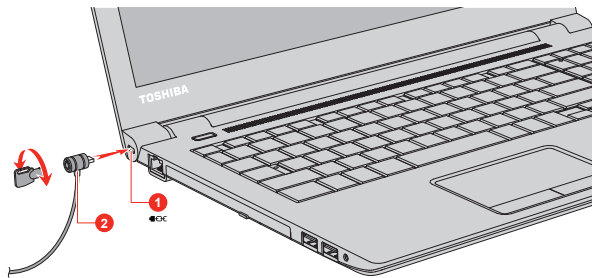

1. Security lock slot

2. Security lock

Optional TOSHIBA Accessories

To make your computer even more powerful and convenient to use, you can add a number of options and accessories. For reference, the following list details some of the items that are available from your reseller or TOSHIBA dealer:

Universal AC Adaptor	If you frequently use your computer at more than one site, it might be convenient to purchase an additional AC adaptor to be kept at each site in order to remove the need to carry the adaptor with you always.
Battery pack	An additional battery pack can be purchased for use as either a spare or replacement. Refer to the Battery section for further information.
TOSHIBA Hi-Speed Port Replicator III 180W/120W	TOSHIBA Hi-Speed Port Replicator III 180W/120W provides several kinds of ports. Refer to the Port Replicator's User's Manual for more details.

Sound System and Video mode

This section describes some of the audio control functions.

Volume Mixer

The Volume Mixer utility lets you control the audio volume for playback of devices and applications under Windows.

- To launch the Volume Mixer utility, right-click on the speaker icon on the Windows Taskbar, and then select **Open Volume Mixer** from the sub menu.
- To adjust the volume level of speakers or headphones, move the **Speakers** slider.
- To adjust the volume level of an application that you are using, move the slider for the corresponding application.

Microphone Level

To change the microphone recording level, do the following:

1. Right-click on the speaker icon on the Windows Taskbar, and select **Recording devices** from the sub menu.
2. Select **Microphone Array**, and click **Properties**.
3. On the **Levels** tab, move the **Microphone Array** slider to increase or decrease the microphone volume level.

If you feel the microphone volume level is inadequate, move the **Microphone Boost** slider to a higher level.

Audio Enhancements

To apply the sound effects for your current speaker, do the following:

1. Right-click on the **Speakers** icon on the Windows Taskbar, and then select **Playback devices** from the sub menu.
2. Select **Speakers**, and click **Properties**.

-
3. On the **Enhancements** tab, select the sound effects you would like, and click **Apply**.

DTS Studio Sound™

DTS Studio Sound™ is a premium audio enhancement suite that utilizes revolutionary audio technology to provide the most immersive and realistic listening experience ever offered for a two speaker playback environment.

DTS Studio Sound™ is provided with some models. It provides the following features:

- Advanced audio rendering to match 2D and 3D video content for enveloping surround sound
- Accurate placement of audio cues for immersive surround sound from any PC speaker configuration laptop / desktop speakers or headphones
- Broad sweet spot with elevated sound image
- Maximum volume output delivering maximum volume without creating clipping or distortion
- Dialog enhancement for clear and intelligible vocals
- Bass enhancement for rich, low frequency production
- High frequency definition for crisp details
- Consistent volume level across content

To access the utility, click **Start -> DTS, Inc -> DTS Studio Sound**.

U.S. patents apply to this product. See <http://patents.dts.com>. Manufactured under license from DTS Licensing Limited.

Realtek HD Audio Manager

You can confirm and change the audio configuration using the **Realtek HD Audio Manager**. To launch the **Realtek HD Audio Manager**:

- Click **Start -> Windows System -> Control Panel -> Hardware and Sound -> Realtek HD Audio Manager**.

When you first launch the Realtek HD Audio Manager, you can see two device tabs. **Speakers** is the default output device. **Microphone Array** is the default input device. To change the default device, click the **Set Default Device** button under the chosen device tab.

Information

Click the **Information** button  to view hardware information, software information, and language setting.

Power Management

The audio controller in your computer can be turned off when the audio function is not used. To adjust the configuration of audio power management, click the **Power Management** button  .

- When audio power management is enabled, the circle button at the upper left of the Power Management is blue and convex.
- When audio power management is disabled, the button is black and concave.

Speaker Configuration

Click the **Auto Test** button  to confirm the internal speakers or the headphone sound is coming from the right direction.

Default Format

You can change the sample rate and bit depth of sound.

Headphone/Microphone selection

To change the type of headphone or microphone, do the following:

1. Plug a headphone or microphone into the headphone/microphone combo jack.
2. Double-click on the circle button  in the right side of the Realtek HD Audio Manager main screen.
3. Select one from the device list for the device you plugged into.

Video mode

Video mode settings are configured via the **Display** dialog.

To open the **Display** dialog, click **Start** ->  (**Settings**) -> **System** -> **Display**.



If you are running some applications (for example a 3D application or video playback), you might see some disturbance, flickering, or frame dropping on your screen.

If that occurs, adjust the resolution of display, lowering it until the screen is displayed properly.

Chapter 5

Utilities and Advanced Usage

This chapter describes the utilities and special features of this computer, and the advanced usage of some utilities.

Utilities and Applications

This section describes the pre-installed utilities that come with the computer and details how to start them. For further information on their operation, refer to online manual, help files, or README.TXT file (if applicable) of each utility.



You might not have all the software listed in this section depending on the model you purchased.

TOSHIBA Settings

TOSHIBA Settings is the TOSHIBA configuration management tool available through the Windows operating system.

To run TOSHIBA Settings, click **Start -> TOSHIBA -> TOSHIBA Settings**.

This utility allows you to configure your computer settings by the following tabs:

- Home—Allows you to view the current BIOS/EC version or change certain settings back to their default values
- eco Utility—Allows you to manage the power consumption of your computer
- USB Charge—Allows you to manage USB Charge features
- Keyboard—Allows you to set options for keyboard and set the brightness level of the keyboard backlight.
- Boot Options—Allows you to manage boot settings
- System Password—Allows you to manage the User Password, Supervisor Password, Owner String and set the User policy.
- Advanced Options—Allows you to set conditions for each device or function



The settings or options explained here might vary depending on the model you purchased.

After you changed the settings, a dialog box might appear to prompt you that the changes will take effect after the computer is restarted. Make sure to restart your computer immediately to apply these changes.

eco Utility

This computer is equipped with "eco mode". This mode slightly lowers performance of some devices to reduce electric power consumption. You can realize measurable power savings by using it continuously.

eco Utility helps control the power consumption of your computer. Various information can help you understand your degree of contribution to the environment.

Furthermore, this utility contains Peak shift function that can help reduce power usage during periods of peak demand by shifting some power consumption to periods when demand is lower.

The utility also supports "eco Charge Mode". The battery will not be fully charged in this mode, thus extending the life cycle of the battery.

It is recommended using the computer with AC adaptor connected as the battery operating time is comparatively short in this mode.

Depending on the usage situation, the life cycle of the battery might not be extended properly.

To access this utility, click **Start -> TOSHIBA -> TOSHIBA Settings -> eco Utility**.

For details on eco Utility, click **Please click here for more information before you use eco Utility** in this tab to see the help file.

USB Charge

Your computer can supply USB Bus power (DC5V) to the USB port.

The port with the icon () supports the following feature:

- USB Sleep and Charge
- System ON CDP Charge

USB Sleep and Charge

You can use the Sleep and Charge function to charge certain USB-compatible external devices such as mobile phones or portable digital music players. Your computer can supply USB bus power (DC5V) to the compatible port even when the computer is turned OFF. "Power OFF" includes Sleep Mode, Hibernation Mode, or shutdown state.

To set USB Sleep and Charge feature, click **Start -> TOSHIBA -> TOSHIBA Settings -> USB Charge**.

Move the slider to enable or disable the Sleep and Charge function.



- *The Sleep and Charge function might not work with certain external devices even if they are compliant with the USB specification. In those cases, turn the power of the computer ON to charge the device.*
- *When Sleep and Charge function is enabled, USB bus power (DC5V) is supplied to compatible ports even when the power of the computer is turned OFF. USB bus power (DC5V) is similarly supplied to the external devices which are connected to the compatible ports. However, some external devices cannot be charged solely by supplying USB bus power (DC5V). As for the specifications of the external devices, contact the device manufacturer or check the specifications of the external devices thoroughly before use.*
- *Using the sleep and charge function to charge external devices takes longer than charging the devices with their own chargers.*
- *If Sleep and Charge function is enabled, the computer's battery discharges during hibernation or when the computer is turned off. It is recommended that you connect the AC adaptor to the computer while using Sleep and Charge function.*
- *External devices connected to the USB bus power (DC5V) function that interfaces with the power ON/OFF of the computer might always be in an operational state.*
- *When there is a current overflow of the external devices connected to the compatible ports, USB bus power (DC5V) supply might be stopped for safety reasons.*
- *When Sleep and Charge function is enabled, the USB Wakeup function might not work for compatible ports. In that case, if there is a USB port that does not have the Sleep and Charge function, attach the mouse or keyboard to it. If all USB ports have the Sleep and Charge function, change to disable Sleep and Charge function. The USB Wakeup function now works, but the Sleep and Charge function is disabled.*



Metal paper clips or hair pins/clips can generate heat if they come into contact with USB ports. Do not allow USB ports to come into contact with metal products, for example when carrying the computer in your bag.

Your PC has multiple charging modes so that many different USB devices can be supported for Sleep and Charge function.

Auto Mode (Default) is suitable for a wide range of digital audio players. While using **Auto Mode**, your computer can supply USB bus power at maximum 2.0A to the compatible ports while the computer is turned off. When USB device cannot be charged by **Auto Mode**, change to **Alternate Mode**.

This function might not be able to be used with some connected external devices even if the appropriate mode is selected. In this situation, disable and stop using this function.

Some external devices cannot use **Auto Mode**. As for the specifications of the external devices, contact the device's manufacture or check the specifications of the external device thoroughly before use.

Always use the USB cable that was included with your USB device.

Function under Battery Mode

This option can be used to enable/disable sleep and charge under battery mode. It also displays the remaining battery capacity.

Move the slider to enable or disable this function.

Enabled	Enables Sleep and Charge function under battery mode.
Disabled	Enables Sleep and Charge function only when the AC adaptor is connected.
Disable features when the battery level reaches	Specifies the lower limit of remaining battery life by moving the slider bar. If the remaining battery life falls below the setting, the Sleep and Charge function is stopped. This setting is only available when the Function under Battery Mode is enabled.

System ON CDP Charge

This function enable/disable CDP (Charging Downstream Port) to use rapid USB charge while the computer is powered on. When "System ON CDP Charge Mode" is enabled, your computer can supply USB bus power (DC5V, 1.5A) to the compatible ports while the computer is turned on.

To set System ON CDP Charge Mode, click **Start -> TOSHIBA -> TOSHIBA Settings -> USB Charge**.

Enabled	Rapid USB battery charge at maximum 1.5A while PC is powered On.
Disabled	Conventional USB battery charge while PC is powered On.



The "System ON CDP Charge Mode" might not work with certain external devices even if they are compliant with the USB specifications. In those cases, use a USB port without "USB Sleep and Charge function" or disable "System ON CDP Charge Mode".

It is recommended that AC adaptor be connected to the computer while supplying USB bus power (DC5V, 1.5A).

When your computer battery capacity is too low to continue, "System ON CDP Charge Mode" might not work. In those cases, connect the AC adaptor and reboot the computer.

Always use the USB cable that was included with your USB device.

When "System ON CDP Charge Mode" or "USB Sleep and Charge function" is enabled, the "USB Wakeup" function might not work. In that case, use a USB port without "USB Sleep and Charge function" or disable both "System ON CDP Charge Mode" and "USB Sleep and Charge function".

System Password

System Password tab allows you to set a password in order to restrict access to the computer. Two levels of password security are provided: User and Supervisor.



Passwords set by System Password function are different from the Windows password.

User Password

To set user password, click **Start -> TOSHIBA -> TOSHIBA Settings -> System Password**.

User authentication might be required to validate user rights when using System Password to delete or change passwords, and so on.

■ **Set** (button)

Click this button to register a password. After a password is set, you are prompted to enter it when you start the computer.



- *After you set the password, a dialog box appears asking whether you want to save it to other media. If you forget the password, you can open the password file on another computer. Be sure to keep the media in a safe place.*
- *When entering the character string to register the password, enter from the keyboard character by character and do not enter as ASCII code or copy-and-paste the character string. In addition, ensure that the registered password is correct by outputting the character string to the password file.*
- *When entering a password, do not enter any characters (for example "!" or "#") produced by pressing the **SHIFT** or **ALT** keys.*

■ **Delete** (button)

Click this button to delete a registered password. Before you can delete a password, you must first enter the current password correctly.

- **Change** (button)

Click this button to change a registered password. Before you can change a password, you must first enter the current password correctly.

- **Owner String** (text box)

You can use this box to associate text with the password. After you enter text, click **Apply** or **OK**. When the computer is started, this text is displayed together with the prompt asking you to enter a password.

Supervisor Password

If you set a Supervisor Password, some functions might be restricted when a user logs on with the User Password. To set a Supervisor Password:

Click **Start -> TOSHIBA -> TOSHIBA Settings -> System Password**. Then click the down arrow next to **Advanced options** to show the **Supervisor Password** settings.

This function lets you do the following:

- Register or delete the Supervisor Password.
- Specify restrictions for general users.

Starting the computer using a password

If you have already registered a user password, there is one way to start the computer:

- Enter the password manually.



The password is necessary if the computer was shut down in Hibernation mode, boot mode or Restart. It is not needed in Sleep mode.

To enter a password manually, do the following:

1. Turn on the power as described in the [Getting Started](#) section. The following message appears in the screen:

Password =



At this point, the function keys do not work. They will function after you enter the password.

2. Enter the Password.
3. Press **ENTER**.



If you enter the password incorrectly three times in a row, or if you do not enter the password within 1 minute, the computer shuts down. In this case, some features that can power on the computer automatically (Wake-up on LAN, Task Scheduler, etc) might not work. You must turn the computer back on to retry password entry.

Pre-Boot Authentication

You can also enable/disable Pre-Boot Authentication function that allows you to authenticate by scanning fingerprints instead of inputting a password before Windows boots up, and Single Sign-On function that allows you to sign on using a fingerprint for both Pre-Boot Authentication and Windows operating system under **Pre-Boot Authentication** in **System Password**.

Please note that Pre-Boot Authentication and Single Sign-On function will be disabled if TOSHIBA Settings is uninstalled.

TOSHIBA Service Station

TOSHIBA Service Station allows your computer to automatically search for TOSHIBA software updates or other alerts from TOSHIBA that are specific to your computer system and its programs.

This utility also provides hardware diagnostic and troubleshooting function and service. The diagnostic or troubleshooting activity log is stored in your computer. When "Send diagnostic and troubleshooting data log" is enabled, the log will be sent to TOSHIBA periodically. The transmission is completely anonymous since no personal identifiable information is collected.

To access this utility, click **Start -> TOSHIBA -> Service Station**.

TOSHIBA Setup Utility

TOSHIBA Setup Utility is a BIOS setup utility that provides you a menu-based user interface so that you can easily view and change BIOS settings.

To enter the TOSHIBA Setup Utility, do the following:

1. Save your work.
2. Click **Start ->  (Power)** and then select **Restart**.
3. Hold down the **F2** key and then release this key just after the computer is power on.
4. Follow the on-screen instructions to proceed.

To save the changes and exit the utility, press the **F10** key and proceed by selecting **Yes** or select **Exit -> Exit Saving Changes -> Yes**. The computer restarts immediately.

TOSHIBA Maintenance Utility

TOSHIBA Maintenance Utility is provided to erase the internal storage drive. This utility allows you to delete all data and partitions, and also overwrite all sectors on the internal storage drive.

If there is an external hard disk drive connected to your computer, it can also be erased. However, if you do not want to delete the data from the external hard disk drive, disconnect it from your computer.

To access this utility:

1. Go to  (**Settings**) and click **Update & Security -> Recovery**.
2. Click **Restart now** under **Advanced startup**.
3. Click **Troubleshoot -> TOSHIBA Maintenance Utility**.

If you select the deletion method and continue with the operation, you will lose all data (including the operating system and recovery partition) on the internal storage drives. Make sure that you have already created recovery media if you want to use the computer after erasing your hard disk drive(s).

Special features

The following features are either unique to TOSHIBA computers or are advanced features which make the computer more convenient to use.

Access each function using the following procedures.

*1 To access the Power Options, click **Start -> Windows System -> Control Panel -> System and Security -> Power Options**.

Display automatic power off *1	This feature automatically cuts off power to the computer's display panel when there is no keyboard input for a specified time, with power being restored the next time a key is pressed. This can be specified in the Power Options.
Internal storage drive automatic power off *1	This feature automatically cuts off power to the internal storage drive when it is not accessed for a specified time, with power being restored when the internal storage drive is next accessed. This can be specified in the Power Options.
System automatic Sleep/Hibernation Mode *1	This feature automatically shuts down the system into either Sleep Mode or Hibernation Mode when there is no input or hardware access for a specified time. This can be specified in the Power Options.
Power on password	Two levels of password security, supervisor and user, are available to prevent unauthorized access to your computer.
Intelligent power supply *1	A microprocessor in the computer's intelligent power supply detects the battery charge, automatically calculates the remaining battery capacity, and protects electronic components from abnormal conditions such as a voltage overload from the AC adaptor. This can be specified in the Power Options.
Battery save mode *1	This feature lets you configure the computer in order to save battery power. This can be specified in the Power Options.

Panel power on/off *1	This feature automatically turns power to the computer off when the display panel is closed, and turns it back on when the display panel is opened. This can be specified in the Power Options.
Low battery automatic Hibernation Mode *1	When battery power is exhausted to the point that computer operation cannot be continued, the system automatically enters Hibernation Mode and shuts itself down. This can be specified in the Power Options.
Sleep Mode	If you have to interrupt your work, you can use this feature to allow you to turn off power to the computer without exiting from your software. Data is maintained in the computer's main memory so that when you next turn on the power, you can continue working right where you left off.
Hibernation Mode	This feature lets you turn off the power to the computer without exiting from your software. The contents of main memory are automatically saved to the internal storage drive so that when you next turn on the power again, you can continue working right where you left off. You must enable the Hibernation Mode before using this feature. Refer to the Starting Hibernation Mode section for more details.
USB Wakeup function	This function restores the computer from Sleep Mode depending on the external devices connected to the USB ports. For example, if a mouse or USB keyboard is connected to a USB port, clicking the mouse button or pressing the keyboard will wakeup the computer.
Wake-up on Wireless LAN	This computer supports the "Wake-up on Wireless LAN" function. The Wake-up on Wireless LAN function consumes power even when the system is in sleep Mode/hibernation Mode. Leave the AC adaptor connected while using this feature.

Heat dispersal *1

To protect against overheating, the processor is equipped with an internal temperature sensor which activates a cooling fan or lowers the processing speed if the computer's internal temperature rises to a certain level. You are able to select whether to control this temperature by either turning on the fan first, then if necessary lowering the processor speed, or by lowering the processor speed first, then if necessary turning on the fan. Both of these functions are controlled through the Power Options.

When the processor's temperature falls within normal range, the fan and the processor operation returns to its standard speed.

If the processor's temperature reaches an unacceptably high level with either setting, the computer automatically shuts down to prevent any damage. In this instance, all unsaved data in memory will be lost.

Chapter 6

Troubleshooting

TOSHIBA has designed this computer for durability, however, should problems occur you are able to use the procedures detailed in this chapter to help determine the cause.

You should become familiar with this chapter as knowing what might go wrong can help prevent problems from occurring in the first place.

Problem-solving process

If you observe the following guidelines, resolving problems will be much easier.

- Stop immediately when you recognize a problem exists as taking further action might result in data loss or damage, or you might destroy valuable problem-related information that can help solve the problem.
- Observe what is happening. Write down what the system is doing and what actions you performed immediately before the problem occurred. Make a screenshot of the current display.

Also be aware that the questions and procedures described in this chapter are meant only as a guide, they are not definitive problem-solving techniques. In reality many problems can be solved simply, but a few might require help from TOSHIBA Support. If you find you need to consult others, be prepared to describe the problem in as much detail as possible.

Preliminary checklist

You should always consider the simplest solution first. The items detailed in this checklist are easy to fix and yet can cause what appears to be a serious problem:

- Make sure that you turn on all peripheral devices before you turn on the computer - this includes your printer and any other external device you are using.
- Before you attach an external device you should first turn off the computer then when you turn the computer back on it recognizes the new device.
- Make sure that all optional accessories are configured properly in the computer's setup program and that all required driver software has been loaded (refer to the documentation included with the optional accessories for further information on its installation and configuration).

-
- Check all cables to ensure that they are correctly and firmly attached to the computer - loose cables can cause signal errors.
 - Inspect all connecting cables for loose wires and all connectors for loose pins.
 - Check that your disc media is correctly loaded

Always try to make detailed notes of your observations and keep them in a permanent error log - this helps you to describe your problems to TOSHIBA Support. In addition, if a problem recurs, the log you have made helps to identify the problem faster.

Analyzing the problem

Sometimes the computer gives you clues that can help you identify why it is malfunctioning. In view of this, keep the following questions in mind:

- Which part of the computer is not operating properly - keyboard, HDD/SSD, display panel, Touch Pad, Touch Pad control buttons - as each device produces different symptoms.
- Check the options within the operating system to ensure that its configuration is set properly.
- What appears on the display? Does it display any messages or random characters? Make a screenshot of the current display and, if possible, look up the messages in the documentation included with the computer, software, or operating system.
- Check that all connecting cables are correctly and firmly attached as loose cables can cause erroneous or intermittent signals.
- Do any indicators light, if so, which ones, what color are they and do they stay on or blink? Write down what you see.
- Do you hear any beeps, if so how many, are they long or short and are they high pitched or low pitched? In addition, is the computer making any unusual noises? Write down what you hear.

Record your observations so you can describe them in detail to TOSHIBA Support.

Software

The problems might be caused by your software or disk. If you cannot load a software package, the media might be damaged or the program might be corrupted. In these instances, try loading another copy of the software if possible.

If an error message appears while you are using a software package, you should refer to the documentation supplied with it as this usually includes a problem-solving section or a summary of error messages.

Next, check any error messages against the operating system documentation.

Hardware

If you cannot find a software problem, you should then check the setup and configuration of your hardware. First run through the items in the preliminary checklist as described previously then, if you still cannot correct the problem, try to identify the source. The next section provides checklists for individual components and peripherals.



Before using a peripheral device or application software that is not an authorized TOSHIBA part or product, make sure that the device or software can be used with your computer. Use of incompatible devices might cause injury or might damage your computer.

If something goes wrong

Your computer does not respond to the keyboard commands

If an error occurs and the computer does not respond to your keyboard commands, do the following:

Press the power button and hold it down for five seconds. Once the computer has turned itself off, wait 10-15 seconds before turning on the power again by pressing the power button.

Your program stops responding

If you are working with a program that suddenly freezes all operations, chances are the program has stopped responding. You can exit the failed program without shutting down the operating system or closing other programs.

To close a program that has stopped responding:

1. Press **CTRL**, **ALT**, and **DEL** simultaneously (once), then click **Task Manager**. The Windows Task Manager window appears.
2. Select the program you want to close, then click **End Task**. Closing the failed program should allow you to continue working. If it does not, continue with the next step.
3. Close the remaining programs one by one by selecting the program name, then **End Task**. Closing all programs should allow you to continue working. If it does not, power off your computer and then restart it.

The computer does not start

Make sure that you attached the AC adaptor and power cord/cable properly.

If you are using the AC adaptor, check that the wall outlet is working by plugging in another device, such as a lamp.

Verify that the computer is on by looking at the **Power** indicator.

If the indicator is glowing, the computer is on. Also, try turning the computer off and then on.

If you are using an AC adaptor, verify that the computer is receiving power from the external power source by looking at the **DC IN/Battery** indicator. If the indicator is glowing, the computer is connected to a live external power source.

The computer does not load advanced options during startup

By holding down one of the following keys during startup, your computer can load the following advanced options.

Key	Advanced option
F2	TOSHIBA Setup Utility
F12	Boot Menu
0 (zero)	Recovery options

If your computer starts to load the Operating System instead of desired advanced options, do the following:

1. Click **Start** ->  (**Power**) and then select **Restart**.
2. Hold down the corresponding key and then release this key just after the computer is power on.
3. Follow the on-screen instructions to proceed.

Hardware and system checklist

This section discusses problems caused by your computer's hardware or attached peripherals. Basic problems might occur in the following areas:

- Power
- Keyboard
- Internal display panel
- HDD
- Optical Disc Drive
- Memory Media Card
- Pointing Device
- Fingerprint sensor
- USB device
- Sound system
- External monitor
- LAN
- Wireless LAN
- Bluetooth®

Power

When the computer is not plugged into an AC power outlet, the battery pack is the primary power source. However, your computer also has a number of other power resources, including an intelligent power supply and a Real-Time Clock (RTC) battery, all of which are interrelated with any one having the ability to produce apparent power problems.

Overheating power down

If the processor's temperature reaches an unacceptably high level with either setting, the computer automatically shuts down to prevent any damage. In this instance, all unsaved data in memory is lost.

Problem	Procedure
Computer shuts down automatically.	Leave the computer off until it reaches room temperature. If the computer has reached room temperature and it still does not start, or if it starts but shuts down quickly, contact TOSHIBA Support.

AC power

If you have trouble turning on the computer with the AC adaptor connected, check the status of the DC IN/Battery indicator. Refer to the [Power Condition Descriptions](#) section for further information.

Problem	Procedure
AC adaptor does not power the computer	<p>Check the connections to make sure that the power cord/adaptor is firmly connected to the computer and a working power outlet.</p> <p>Check the condition of the cord and terminals. If the cord is frayed or damaged it should be replaced, while if the terminals are soiled, they should be cleaned with a clean cotton cloth.</p> <p>If the AC adaptor still does not power the computer, you should contact TOSHIBA Support.</p>

Battery

If you suspect a problem with the battery, check the status of the **DC IN/Battery** indicator.

Problem	Procedure
Battery does not power the computer	The battery might be discharged. Connect the AC adaptor to recharge the battery.

Problem	Procedure
<p>Battery does not charge when the AC adaptor is attached.</p>	<p>If the battery is completely discharged, it will not begin charging immediately. In these instances, wait a few minutes before trying again. If the battery still does not charge, check that the power outlet the AC adaptor is connected to its supplying power. This can be tested by plugging another appliance into it.</p> <p>Check whether the battery is hot or cold to the touch - if so, it will not charge properly and should be allowed to reach room temperature before you try again.</p> <p>Unplug the AC adaptor and remove the battery to make sure its connecting terminals are clean - if necessary wipe them with a soft dry cloth lightly dipped in alcohol.</p> <p>Connect the AC adaptor and replace the battery, taking care to ensure that it is securely seated in the computer.</p> <p>Check the DC IN/Battery indicator. If it does not glow, allow the computer to charge the battery for at least twenty minutes. If the DC IN/Battery indicator starts to glow after this period, allow the battery to continue to charge for at least another twenty minutes before turning on the computer. However, if the indicator still does not glow, the battery might be at the end of its operating life and should be replaced. However, if you do not believe the battery is at the end of its operating life, you should speak to TOSHIBA Support.</p>
<p>Battery does not power the computer as long as expected</p>	<p>If you frequently recharge a partially charged battery, the battery might not charge to its full potential. In these instances, you should fully discharge the battery and then attempt to charge it again.</p> <p>Check the Power saver option under Create a power plan in the Power Options.</p>

Real Time Clock

Problem	Procedure
The BIOS setting and system date/time are lost.	<p>If the RTC battery becomes completely discharged, the realtime clock and calendar will stop working. The RTC battery should be replaced only by your dealer or by a TOSHIBA servicere presentative, and then set the date/time in the TOSHIBA Setup Utility by using the following steps:</p> <ol style="list-style-type: none">1. Launch the TOSHIBA Setup Utility. Refer to the TOSHIBA Setup Utility section for further information.2. Set the date in the System Date field.3. Set the time in the System Time field.4. Follow the on-screen instructions to proceed.

BIOS

Problem	Procedure
The computer cannot be powered on	<p>Disconnect the AC adaptor for several seconds and then reconnect the AC adaptor. After that, press the power button.</p> <p>If it does not work, press the power button twice again.</p> <p>If it still does not work, press and hold the power button for 12 seconds.</p> <p>Real-Time Clock (RTC) information might be cleared if the power is turned on by pressing the power button. You should set the system date/time manually in TOSHIBA Setup Utility.</p> <p>If it still does not operate properly, you should contact your reseller or dealer.</p>

Keyboard

Keyboard problems can be caused by the setup and configuration of the computer. Refer to the [The Keyboard](#) section for further information.

Problem	Procedure
Output to screen is garbled	<p>Refer to your software documentation to ensure that it is not remapping the keyboard in any way (remapping involves changing or reassigning the function of each key).</p> <p>If you are still unable to use the keyboard, you should contact TOSHIBA Support.</p>

Internal display panel

Apparent problems of the computer's display panel might be related to setup and configuration of the computer.

Problem	Procedure
No display	Press the function keys to adjust the display priority, and to make sure that it is not set for output to an external monitor.
Markings appear on the computer's display panel.	These marks might have come from contact with the keyboard and Touch Pad while the display panel has been closed. Try to remove the marks by gently wiping the display panel with a clean dry cloth or, if this fails, with a good quality LCD screen cleaner. In this latter instance, you should always follow the instructions with the screen cleaner and always ensure that you let the display panel dry properly before closing it.

Internal Storage

Problem	Procedure
Computer does not boot from internal storage	<p>Check to see whether there is a disc in the optical disc drive - if so remove it and try to start the computer again.</p> <p>If this has no effect, check the Boot Priority Options setting under Change Boot Order within the TOSHIBA Setup Utility.</p>

Problem	Procedure
Slow performance	<p>The files on the HDD might be fragmented. In this instance you should run the disk defragmentation utility to check the condition of your files and the HDD. Refer to the operating system's documentation or online Help File for further information on operating and using the Defragmentation utility.</p> <p>As a last resort, you should reformat the HDD and then reload the operating system and all other files and data. If you are still unable to resolve the problem, contact TOSHIBA Support.</p>

Optical Disc Drive

For further information, refer to [Operating Basics](#).

Problem	Procedure
You cannot access a disc in the optical disc drive	<p>Make sure the drive's disc tray is securely closed. Press gently until it clicks into place.</p> <p>Open the disc tray and make sure the disc is properly seated. It should lie flat with the label facing up.</p> <p>A foreign object in the disc tray might block laser light from reading the disc. Make sure there is no obstruction. Remove any foreign object.</p> <p>Check whether the disc is dirty. If it is, wipe it with a clean cloth dipped in water or a neutral cleaner.</p>

Memory Media Card

For further information, refer to [Operating Basics](#).

Problem	Procedure
Memory media card error occurs	<p>Remove the memory media card from the computer and then reinsert it in order to ensure that it is firmly connected.</p> <p>If the problem persists, then you should refer to the documentation supplied with your memory media card for further information.</p>
You cannot write to a memory media card	<p>Remove the memory media card from the computer and check to ensure that it is not write protected.</p>

Problem	Procedure
You cannot read a file	<p>Check to ensure the required file is actually on the memory media card that is inserted into the computer.</p> <p>If you are still unable to resolve the problem, contact TOSHIBA Support.</p>

Pointing device

If you are using a USB mouse, you should also refer to both the [USB mouse](#) section and the documentation supplied with your mouse.

Touch Pad

Problem	Procedure
The Touch Pad does not work.	<p>Check the Device Settings.</p> <p>Click Start -> Windows System -> Control Panel -> Hardware and Sound -> Mouse.</p>
Mouse pointer does not respond to pointing device operation	<p>In this instance, the system might be busy. Try moving the mouse again after waiting a short while.</p>
Double-tapping (Touch Pad) does not work	<p>In this instance, you should initially try changing the double-click speed setting within the Mouse Control utility.</p> <ol style="list-style-type: none"> To access this utility, click Start -> Windows System -> Control Panel -> Hardware and Sound -> Mouse. Within the Mouse Properties window, click the Buttons tab. Set the double-click speed as required and click OK.
The mouse pointer moves too fast or too slow	<p>In this instance, you should initially try changing the speed setting within the Mouse Control utility.</p> <ol style="list-style-type: none"> To access this utility, click Start -> Windows System -> Control Panel -> Hardware and Sound -> Mouse. Within the Mouse Properties window, click the Pointer Options tab. Set the mouse pointer speed as required and click OK.

Problem	Procedure
The reaction of Touch Pad is either too sensitive or not sensitive enough.	<p>Adjust the touch sensitivity.</p> <p>To access it, click Start -> Windows System -> Control Panel -> Hardware and Sound -> Mouse.</p> <p>If you are still unable to resolve the problem, contact TOSHIBA Support.</p>

USB mouse

Problem	Procedure
Mouse pointer does not respond to mouse operation	<p>In this instance, the system might be busy. Try moving the mouse again after waiting a short while.</p> <p>Remove the mouse from the computer and then reconnect it to a free USB port in order to ensure that it is firmly attached.</p>
Double-clicking does not work	<p>In this instance, you should initially try changing the double-click speed setting within the Mouse Control utility.</p> <ol style="list-style-type: none"> To access this utility, click Start -> Windows System -> Control Panel -> Hardware and Sound -> Mouse. Within the Mouse Properties window, click the Buttons tab. Set the double-click speed as required and click OK.
The mouse pointer moves too fast or too slow	<p>In this instance, you should initially try changing the speed setting within the Mouse Control utility.</p> <ol style="list-style-type: none"> To access this utility, click Start -> Windows System -> Control Panel -> Hardware and Sound -> Mouse. Within the Mouse Properties window, click the Pointer Options tab. Set the mouse pointer speed as required and click OK.
The mouse pointer moves erratically	<p>The elements of the mouse responsible for detecting movement might be dirty. Refer to the documentation supplied with the mouse for instructions on how to clean it.</p> <p>If you are still unable to resolve the problem, contact TOSHIBA Support.</p>

Fingerprint sensor

Problem	Procedure
Fingerprints cannot be registered or deleted.	<ol style="list-style-type: none">1. Save your work.2. Click Start ->  (Power) and then select Restart.3. Hold down the F2 key and then release this key just after the computer is power on to show the TOSHIBA Setup Utility.4. Select Security -> BIOS Password -> Supervisor, and then register the Supervisor Password. (If the User Password has been registered, clear it first.)5. Select Clear Fingerprint data, and then press Yes.6. Clear Supervisor Password. (If necessary, register the User Password again after that.)7. To save the changes and exit the utility, press the F10 key and proceed by selecting Yes or select Exit -> Exit Saving Changes -> Yes. <p>The computer restarts immediately.</p>

USB device

In addition to the information in this section, also refer to the documentation supplied with your USB device.

Problem	Procedure
USB device does not work	<p>Remove the USB device from the computer and then reconnect it to a free port in order to ensure that it is firmly attached.</p> <p>Ensure that any required USB device drivers are properly installed. To achieve this, you should refer to both the device documentation and the operating system documentation.</p>

Sleep and Charge function

For more information and settings, refer to the [USB Charge](#) section.

Problem	Procedure
<p>I cannot use the Sleep and Charge function.</p>	<p>Sleep and Charge function might be disabled. Enable the Sleep and Charge function under USB Charge within the TOSHIBA Settings.</p> <p>When there is a current overflow of the external device connected to the compatible port, USB bus power (DC5V) supply might be stopped for safety reasons. When this happens, disconnect an external device if some external devices are connected. After that, turn the power of the computer ON/OFF to restore the function. If this function cannot be still used even if only one external device is connected, stop using the external device because its current is over the acceptable value of this computer.</p> <p>Some external devices might not be able to use the Sleep and Charge function. In this case, please try one or more of the following methods.</p> <ul style="list-style-type: none"> ■ Turn OFF the computer while external devices are connected. ■ Connect external devices after turning OFF of the computer. <p>If this function cannot be still used, change the setting to disable the function and stop using this function.</p>
<p>The battery depletes quickly even when I turned OFF the power of the computer.</p>	<p>If Sleep and Charge function is enabled, the computer's battery discharges during hibernation or when the computer is turned off.</p> <p>Connect the AC adaptor to the computer or disable the Sleep and Charge function.</p>
<p>External devices connected to the compatible ports do not work when connected to a compatible port.</p>	<p>Some external devices might not work when connected to a compatible port if the Sleep and Charge function is enabled.</p> <p>Reconnect the external device after turning the computer ON.</p> <p>If the external device still does not work, connect device to an USB port that does not have the Sleep and Charge function or change to disable the Sleep and Charge function.</p>

Problem	Procedure
The "USB Wakeup function" does not work.	<p>When "System ON CDP Charge Mode" or "USB Sleep and Charge function" is enabled, the "USB WakeUp" function does not work for ports that support the Sleep and Charge function.</p> <p>In that case, use a USB port that does not have the USB Sleep and Charge function or change to disable both "System ON CDP Charge Mode" and "USB Sleep and Charge function".</p>

Sound system

In addition to the information in this section, also refer to the documentation supplied with your audio device.

Problem	Procedure
No sound is heard	<p>Press the function keys to increase or decrease volume.</p> <p>Check the software volume settings.</p> <p>Check to see if Mute is turned to Off</p> <p>Check to make sure that the headphone connection is secure.</p> <p>Check within the Windows Device Manager application to ensure that the sound device is enabled and that the device is properly working.</p>
Annoying sound is heard	<p>In this instance, you might be experiencing feedback from either the internal microphone or an external microphone connected to the computer. Refer to Sound System and Video mode for further information.</p> <p>Volume cannot be adjusted during Windows start up or shut down.</p> <p>If you are still unable to resolve the problem, contact TOSHIBA Support.</p>

External monitor

Also refer to [Operating Basics](#), and to the documentation supplied with your monitor for further information.

Problem	Procedure
Monitor does not turn on	After confirming that the monitor's power switch is on, check the connections to make sure that the power cord/adaptor is firmly connected to the monitor and to a working power outlet.
No display	<p>Try adjusting the contrast and brightness controls on the external monitor.</p> <p>Press the function key in order to change the display priority and ensure that it is not set for the internal display only.</p> <p>Check to see if the external monitor is connected.</p> <p>When the external monitor is set as the primary display device in extended desktop mode, it does not display when the computer wakes up from Sleep Mode if the external monitor has been disconnected while in Sleep Mode.</p> <p>To keep this from happening, do not disconnect the external monitor while the computer is in Sleep or Hibernation Mode.</p> <p>Remember to turn off the computer before disconnecting the external monitor.</p> <p>When the display panel and an external monitor are set to clone mode and they are turned off by the timer, the display panel or the external monitor might not display when turned on again.</p> <p>If this occurs, press the function key to reset the display panel and external monitor to clone mode.</p> <p>When booting up the computer, screen of BIOS setting and etc. might not be indicated correctly if the power saving function of external monitor is enabled. In this case, turn the power of external monitor OFF and ON once (to disable power saving function) and then restart your computer.</p>
Display error occurs	<p>Check that the cable connecting the external monitor to the computer is firmly attached.</p> <p>If you are still unable to resolve the problem, contact TOSHIBA Support.</p>

LAN

Problem	Procedure
Cannot access LAN	Check for a firm cable connection between the LAN jack and the LAN hub.
Wake-up on LAN does not work	Make sure the AC adaptor is connected. The Wake-up on LAN function consumes power even when the system is off. If problems persist, consult your LAN administrator.

Wireless LAN

Problem	Procedure
Cannot access Wireless LAN	Make sure that the wireless communication function of the computer is on. If problems persist, contact your LAN administrator.

Bluetooth®

Problem	Procedure
Cannot access Bluetooth® device	Check to ensure that the wireless communication function of the computer is on. Check to ensure that the Bluetooth® Manager application is running on the computer and that power to the external Bluetooth® device is turned on. Check to ensure that no optional Bluetooth® Adaptor is installed in the computer. The built-in Bluetooth® hardware cannot operate simultaneously with another Bluetooth® controller. If you are still unable to resolve the problem, contact TOSHIBA Support.

TOSHIBA support

If you require any additional help using your computer or if you are having problems operating the computer, you might need to contact TOSHIBA for additional technical assistance.

Before you call

Some problems you experience might be related to software or the operating system so it is important that you investigate other sources of assistance first. Before contacting TOSHIBA, try the following:

- Review troubleshooting sections in the documentation supplied with your software and/or peripheral devices.
- If a problem occurs when you are running software applications, consult the software documentation for troubleshooting suggestions and consider calling the software company's technical support department for assistance.
- Consult the reseller or dealer from where you purchased your computer and/or software - they are your best resource for current information and support.

TOSHIBA technical support

If you are still unable to solve the problem and suspect that it is hardware-related, read the enclosed warranty booklet or visit the TOSHIBA technical support website

<http://pc-support.toshiba.eu>

Chapter 7

Appendix

Specifications

This section summarizes the technical specifications of the computer.

Physical Dimensions

The following physical dimensions do not include parts that extend beyond the main body. The physical dimensions vary depending on the model you purchased.

Size	■ Approximately 379.0 (w) x 258.0 (d) x 23.35~24.05 (h) millimeters (not including parts that extend beyond the main body).
-------------	--

Environmental Requirements

Conditions	Ambient temperature	Relative humidity
Operating	5°C (41°F) to 35°C (95°F)	20% to 80% (noncondensing)
Non-operating	-20°C (-4°F) to 60°C (140°F)	10% to 90% (noncondensing)
Wet-bulb temperature	29°C maximum	

Conditions	Altitude (from sea level)
Operating	-60 to 3,000 meters
Non-operating	-60 to 10,000 meters maximum

Power Requirements

AC adaptor	100-240V AC 50 Hz or 60 Hz (cycles per second)
Computer	19 V DC

External RGB monitor port pin assignment

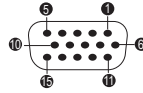

Pin	Signal Name	Description	I/O
1	CRV	Red Video Signal	O
2	CGV	Green Video Signal	O
3	CBV	Blue Video Signal	O
4	Reserved	Reserved	
5	GND	Ground	
6	GND	Ground	
7	GND	Ground	
8	GND	Ground	
9	+5V	Power Supply	
10	GND	Ground	
11	Reserved	Reserved	
12	SDA	Serial Data Signal	I/O
13	HSYNC	Horizontal Sync Signal	O
14	VSNC	Vertical Sync Signal	O
15	SCL	Serial Clock Signal	O

I/O (I): Input to computer

I/O (O): Output from computer

AC Power Cord and Connectors

The AC input plug of the power cord must be compatible with the various international AC power outlets and the cord must meet the standards for the country/region in which it is used. All cords must meet the following specifications:

Wire size:	Minimum 0.75 mm ²
Current rating:	Minimum 2.5 amperes

Certification agencies

China:	CQC		
U.S. and Canada:	UL listed and CSA certified No. 18 AWG, Type SVT or SPT-2		
Australia:	AS		
Japan:	DENANHO		
Europe:			
Austria:	OVE	Italy:	IMQ
Belgium:	CEBEC	The Netherlands:	KEMA
Denmark:	DEMKO	Norway:	NEMKO
Finland:	FIMKO	Sweden:	SEMKO
France:	LCIE	Switzerland:	SEV
Germany:	VDE	United Kingdom:	BSI

In Europe, two conductors power cord must be VDE type, H05VVH2-F or H03VVH2-F and for three conductors power cord must be VDE type, H05VV-F.

For the United States and Canada, two-pin plug configuration must be a 2-15P (250 V) or 1-15P (125 V) and three-pin plug configuration must be 6-15P (250 V) or 5-15P (125 V) as designated in the U.S. National Electrical code handbook and the Canadian Electrical Code Part II.

The following illustrations show the plug shapes for the U.S.A. and Canada, the United Kingdom, Australia, Europe, Middle-East, Africa, South Africa, Switzerland, Italy and China.

USA

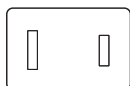

UL approved

United Kingdom, South Africa, Middle-East

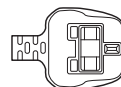

BS approved

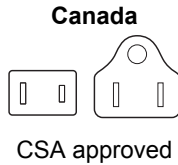
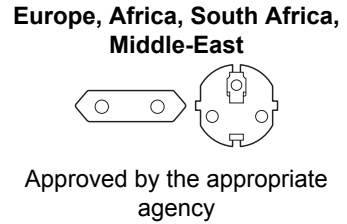
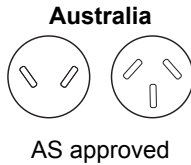

Information for Wireless Devices

Wireless Technology Interoperability

The Wireless LAN is compatible with other LAN systems Direct Sequence Spread Spectrum (DSSS) /Orthogonal Frequency Division Multiplexing (OFDM) radio technology, and is compliant to:

- The IEEE 802.11 Standard on Wireless LANs (Revision a/b/g/n, b/g/n or Revision a/b/g/n/ac), as defined and approved by the Institute of Electrical and Electronics Engineers.

Bluetooth® Modules are designed to be interoperable with any product with Bluetooth® wireless technology that is based on Frequency Hopping Spread Spectrum (FHSS) radio technology, and is compliant to:

- Bluetooth® Specification (depending on the model you purchased), as defined and approved by the Bluetooth® Special Interest Group.
- Logo certification with Bluetooth® wireless technology as defined by the Bluetooth® Special interest Group.

This Bluetooth® product is not compatible with devices using Bluetooth® Version 1.0B specifications.



The wireless devices have not completed verification of connection and operation with all devices which are using the Wireless LAN or Bluetooth® radio technology.

Bluetooth® and Wireless LAN devices operate within the same radio frequency range and might interfere with one another. If you use Bluetooth® and Wireless LAN devices simultaneously, you might occasionally experience a less than optimal network performance or even lose your network connection.

If you experience any such problem, immediately turn off either one of your Bluetooth® or Wireless LAN.

If you have any questions about using Wireless LAN or Bluetooth® Module, visit <http://www.pc.support.global.toshiba.com>

In Europe, visit

<http://www.toshiba-europe.com/computers/tnt/bluetooth.htm>

Wireless devices and your health

Wireless products, like other radio devices, emit radio frequency electromagnetic energy. The level of energy emitted by wireless products however is far much less than the electromagnetic energy emitted by wireless devices like for example mobile phones.

Because wireless products operate within the guidelines found in radio frequency safety standards and recommendations, TOSHIBA believes wireless products are safe for use by consumers. These standards and recommendations reflect the consensus of the scientific community and result from deliberations of panels and committees of scientists who continually review and interpret the extensive research literature.

In some situations or environments, the use of wireless products might be restricted by the proprietor of the building or responsible representatives of the organization. These situations might for example include:

- Using the wireless products equipment on board of airplanes, or
- In any other environment where the risk of interference to other devices or services is perceived or identified as harmful.

If you are uncertain of the policy that applies on the use of wireless devices in a specific organization or environment (for example, airports), you are encouraged to ask for authorization to use the wireless device prior to turning on the equipment.

Wireless LAN Technology

The wireless communication function of the computer supports some wireless communication devices.

Only some models are equipped with both Wireless LAN and Bluetooth® functions.



- *Do not use the Wireless LAN (Wi-Fi®) or Bluetooth® functionalities near a microwave oven or in areas subject to radio interference or magnetic fields. Interference from a microwave oven or other source can disrupt Wi-Fi® or Bluetooth® operation.*
- *Turn off all wireless functionalities when near a person who might have a cardiac pacemaker implant or other medical electric device. Radio waves might affect pacemaker or medical device operation, possibly resulting in serious injury. Follow the instruction for your medical device when using any wireless functionality.*
- *Always turn off wireless functionality if the computer is near automatic control equipment or appliances such as automatic doors or fire detectors. Radio waves can cause malfunction of such equipment, possibly resulting in serious injury.*
- *It might not be possible to make a network connection to a specified network name using the ad hoc network function. If this occurs, the new network (*) has to be configured for all computers connected to the same network in order to re-enable network connections.
* Make sure to use new network name.*

Security

- TOSHIBA strongly recommends that you enable encryption functionality, otherwise your computer is open to illegal access by an outsider using a wireless connection. If this occurs, the outsider might illegally access your system, eavesdrop, or cause the loss or destruction of stored data.
- TOSHIBA is not liable for the loss of data due to eavesdropping or illegal access through the wireless LAN and the damage thereof.

Card Specifications

Compatibility	■ IEEE 802.11 Standard for Wireless LANs
Network Operating System	■ Microsoft Windows Networking
Media Access Protocol	■ CSMA/CA (Collision Avoidance) with Acknowledgment (ACK)

Radio Characteristics

Radio Characteristics of Wireless LAN module might vary according to:

- Country/region where the product was purchased
- Type of product

Wireless communication is often subject to local radio regulations. Although Wireless LAN wireless networking products have been designed for operation in the license-free 2.4 GHz and 5 GHz band, local radio regulations might impose a number of limitations to the use of wireless communication equipment.

-
- | | |
|------------------------|---|
| Radio Frequency | ■ Band 5 GHz (5150-5850 MHz) (Revision a and n) |
| | ■ Band 2.4 GHz (2400-2483.5 MHz) (Revision b/g and n) |
-

The range of the wireless signal is related to the transmit rate of the wireless communication. Communications at lower transmit range might travel larger distances.

- The range of your wireless devices can be affected when the antennas are placed near metal surfaces and solid high-density materials.
- Range is also impacted due to "obstacles" in the signal path of the radio that might either absorb or reflect the radio signal.

Radio Frequency Interference Requirements

This device is restricted to indoor use due to its operation in the 5.15 to 5.25GHz frequency range.

High-power radars are allocated as primary users (i.e. priority users) of the bands 5.25 to 5.35GHz and 5.65 to 5.85GHz and that these radars could cause interference and/or damage to LE-LAN devices.

Bluetooth® wireless technology

Some computers in this series have Bluetooth® wireless communication function which eliminates the need for cables between electronic devices such as computers, printers, and mobile phones. When it is enabled, Bluetooth® provides the wireless personal area network environment which is safe and trustworthy, that is quick and easy.

You cannot use the built-in Bluetooth® functions of the computer and an external Bluetooth® adaptor simultaneously. For reference, Bluetooth® wireless technology has the following features:

Security

Two advanced security mechanisms ensure a high level of security:

- Authentication prevents access to critical data and makes it impossible to falsify the origin of a message.
- Encryption prevents eavesdropping and maintains link privacy.

Worldwide operation

The Bluetooth® radio transmitter and receiver operate in the 2.4 GHz band, which is license-free and compatible with radio systems in most countries in the world.

Radio links

You can easily establish links between two or more devices, with these links being maintained even if the devices are not within a line-of-sight of each other.

Radio Regulatory Information

The Wireless device must be installed and used in strict accordance with the manufacturer's instructions as described in the user documentation that comes with the product. This product complies with the following radio frequency and safety standards.

Europe

Restrictions for Use of 2400.0-2483.5MHz Frequencies in Europe

Azerbaijan:	Limited implementation	No license needed if used indoor and power not exceeding 30 mW (14.77dBm).
Italy:  IT	Implemented	The public use is subject to general authorisation by the respective service provider.

Russian Federation:	Limited implementation	Using SRD (Short Range Device) with FHSS (Frequency-Hopping Spread Spectrum) modulation. <ol style="list-style-type: none">1. Maximum 2.5mW (4dBm) EIRP (Equivalent Isotropically Radiated Power) is permitted to use.2. Maximum 100mW (20dBm) EIRP is permitted to use with the following conditions:<p>Permitted to use SRD for outdoor applications without restriction on installation height only for purposes of gathering telemetry information for automated monitoring and resources accounting systems. Permitted to use SRD for other purposes for outdoor applications only when the installation height is not exceeding 10m above the ground surface.</p>3. Maximum 100mW (20dBm) EIRP.<p>Indoor applications is permitted to use.</p>
----------------------------	------------------------	--

Using SRD with DSSS (Direct Sequence Spread Spectrum) and other than FHSS wideband modulation.

1. Maximum EIRP density is 2mW/MHz. Maximum 100mW (20dBm) EIRP is permitted to use.
2. Maximum EIRP density is 20mW/MHz. Maximum 100mW (20dBm) EIRP is permitted to use with the following condition:

It is permitted to use SRD for outdoor applications only for purposes of gathering telemetry information for automated monitoring and resources accounting systems or security systems.

3. Maximum EIRP density is 10mW/MHz. Maximum 100mW (20dBm) EIRP.

Indoor applications is permitted to use.

Ukraine:	Limited implementation	EIRP =100mW (20dBm) with built-in antenna's maximum gain is 6dBi.
-----------------	------------------------	---

Restrictions for Use of 5725-5875MHz Frequencies in Europe

Russian Federation:	Limited implementation	When duty cycle is 0.1% or using LBT (Listen Before Talk) technology. Antenna height should not exceed 5m, with maximum EIRP 25mW (13.98dBm) is permitted to use.
----------------------------	------------------------	---

Software Version and Maximum Power Output of the Wireless Module

Europe: model 8265NGW

Software Version	Intel® PROSet/Wireless WiFi Software 19.x and previous versions
-------------------------	---

Maximum Power Output

(2400 - 2483.5 MHz) IEEE802.11 b/g/n mode / Bluetooth	Maximum 100mW (20dBm) EIRP
(2400 - 2483.5 MHz) BLE	Maximum 10mW (10dBm) EIRP
(5150 - 5725 MHz) IEEE802.11 a/n/ac mode	Maximum 200mW (23dBm) EIRP The low band 5.15 - 5.35 GHz is for indoor use only.
(5745 - 5875 MHz) IEEE802.11 a/n/ac mode	Maximum 25mW (13.98dBm) EIRP

Europe: model 3165NGW

Software Version

Intel® PROSet/Wireless WiFi Software 19.x and previous versions

Maximum Power Output

(2400 - 2483.5 MHz) IEEE802.11 b/g/n mode	Maximum 100mW (20dBm) EIRP
(2400 - 2483.5 MHz) BLE / Bluetooth	Maximum 10mW (10dBm) EIRP
(5150 - 5725 MHz) IEEE802.11 a/n/ac mode	Maximum 200mW (23dBm) EIRP The low band 5.15 - 5.35 GHz is for indoor use only.
(5745 - 5875 MHz) IEEE802.11 a/n/ac mode	Maximum 25mW (13.98dBm) EIRP

To remain in conformance with European spectrum usage laws for Wireless LAN operation, the above 2.4GHz and 5GHz channel limitations apply for outdoor usage. The user should use the wireless LAN utility to check the current channel of operation. If operation is occurring outside of the allowable frequencies for outdoor use, as listed above, the user must contact the applicable national spectrum regulator to request a license for outdoor operation.

Canada - Industry Canada (IC)

This device complies with RSS-247 of the Industry Canada Rules. Operation is subject to the following two conditions: (1) This device may not cause harmful interference, and (2) this device must accept any interference received, including interference that may cause undesired operation.

Ce dispositif est conforme à la norme CNR-247 d'Industrie Canada applicable aux appareils radio exempts de licence. Son fonctionnement est

sujet aux deux conditions suivantes: (1) le dispositif ne doit pas produire de brouillage préjudiciable, et (2) ce dispositif doit accepter tout brouillage reçu, y compris un brouillage susceptible de provoquer un fonctionnement indésirable.

Les dispositifs fonctionnant dans la bande 5.15-5.25GHz sont réservés uniquement pour une utilisation à l'intérieur afin de réduire les risques de brouillage préjudiciable aux systèmes de satellites mobiles utilisant les mêmes canaux.

Les utilisateurs devraient aussi être avisés que les utilisateurs de radars de haute puissance sont désignés utilisateurs principaux (c.-à-d., qu'ils ont la priorité) pour les bandes 5.25-5.35GHz et 5.65-5.85GHz et que ces radars pourraient causer du brouillage et/ou des dommages aux dispositifs LAN-EL.

The term "IC" before the equipment certification number only signifies that the Industry Canada technical specifications were met.

USA-Federal Communications Commission (FCC)

This equipment has been tested and found to comply with the limits for a Class B digital device, pursuant to Part 15 of FCC Rules. These limits are designed to provide reasonable protection against harmful interference in a residential installation.

Refer to the FCC information section for the detailed information.

Caution: Exposure to Radio Frequency Radiation

The radiated output power of the Wireless device is far below the FCC radio frequency exposure limits. Nevertheless, the Wireless device shall be used in such a manner that the potential for human contact during normal operation is minimized.

In the usual operating configuration, the distance between the antenna and the user should not be less than 20cm. Please refer to the computer user's manual for the details regarding antenna location.

The installer of this radio equipment must ensure that the antenna is located or pointed such that it does not emit RF field in excess of Health Canada limits for the general population; consult Safety Code 6, obtainable from Health Canada's website

www.hc-sc.gc.ca

Caution: Radio Frequency Interference Requirements

This device is restricted to indoor use due to its operation in the 5.15 to 5.25GHz frequency range.

High-power radars are allocated as primary users (i.e. priority users) of the bands 5.25 to 5.35GHz and 5.65 to 5.85GHz and that these radars could cause interference and/or damage to LE-LAN devices.

Taiwan

Article 12	Without permission granted by the NCC, any company, enterprise, or user is not allowed to change frequency, enhance transmitting power or alter original characteristic as well as performance to an approved low power radio frequency devices.
Article 14	<p>The low power radio-frequency devices shall not influence aircraft security and interfere legal communications;</p> <p>If found, the user shall cease operating immediately until no interference is achieved.</p> <p>The said legal communications means radio communications is operated in compliance with the Telecommunications Act.</p> <p>The low power radio-frequency devices must be susceptible with the interference from legal communications or ISM radio wave radiated devices.</p>

Australia and New Zealand regulatory compliance

This equipment incorporates a radio transmitting device, in normal use a separation distance of 20cm will ensure radio frequency exposure levels complies with the Australian and New Zealand Standards.

Using this equipment in Japan

In Japan, the frequency bandwidth of 2,400MHz to 2,483.5MHz for second generation low-power data communication systems such as this equipment overlaps that of mobile object identification systems (premises radio station and specified low-power radio station).

1. Important notice

The frequency bandwidth of this equipment may operate within the same range as industrial devices, scientific devices, medical devices, microwave ovens, licensed radio stations and non-licensed specified low-power radio stations for mobile object identification systems (RFID) used in factory production lines (Other Radio Stations).

1. Before using this equipment, ensure that it does not interfere with any of the equipment listed above.
2. If this equipment causes RF interference to other radio stations, promptly change the frequency being used, change the location of use, or turn off the source of emissions.

- Contact an authorized TOSHIBA service provider if you have problems with interference caused by this product to Other Radio Stations.

2. Indication for Wireless LAN

The indication shown below appears on this equipment.

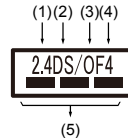

- 2.4 : This equipment uses a frequency of 2.4 GHz.
- DS : This equipment uses DS-SS modulation.
- OF : This equipment uses OFDM modulation.
- 4 : The interference range of this equipment is less than 40 m.
- : This equipment uses a frequency bandwidth from 2,400 MHz to 2,483.5 MHz. It is possible to avoid the band of mobile object identification systems.

3. Indication for Bluetooth®

The indication shown below appears on this equipment.

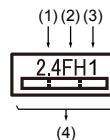

- 2.4 : This equipment uses a frequency of 2.4 GHz.
- FH : This equipment uses FH-SS modulation.
- 1 : The interference range of this equipment is less than 10 m.
- : This equipment uses a frequency bandwidth from 2,400 MHz to 2,483.5 MHz. It is impossible to avoid the band of mobile object identification systems.

4. About the JEITA

5 GHz Wireless LAN supports W52/W53/W56 Channel.



Device Authorization

This device obtains the Technical Regulation Conformity Certification and it belongs to the device class of radio equipment of low-power data communication system radio station stipulated in the Telecommunications Business Law of Japan.

- Intel® Dual Band Wireless-AC 8265

The Name of the radio equipment: 8265NGW

DSP Research, Inc.

Approval Number: D160055003

- Intel® Dual Band Wireless-AC 3165

The Name of the radio equipment: 3165NGW

DSP Research, Inc.

Approval Number: D150008003

The following restrictions apply:

- Do not disassemble or modify the device.
- Do not install the embedded wireless module into other device.

Information about Intel® AMT

Your computer might support Intel® Active Management Technology (AMT) depending on the model you purchased.

Using built-in platform capabilities and popular third-party management and security applications, Intel® AMT allows IT to better discover, heal, and protect their networked computing assets.

Consult with your system administrator about configurations of the AMT function before connecting to a network.

Disable the AMT function

Intel® AMT function is enabled by default, and in a situation where no system administrator presents, it is strongly recommended that you turn off the AMT function before connecting to a network.

If the AMT function is NOT turned off, there is a danger that the management of AMT function will be abused by other parties which possibly lead to the leak of sensitive and/or proprietary information, data loss, HDD/SSD erasure, or file overwritten.

First, you must do the following in the BIOS setup utility:

1. Turn on the computer while pressing the **F2** key.
2. On the BIOS setup utility screen, change AMT Setup Prompt to **Enabled**.
3. Press the **F10** key, and press **Y** key to save the settings.

When the computer restarts, the message "Press < Ctrl + P > to enter MEBx Setup Menu" appears. Press **CTRL + P** to enter the MEBx Setup.

To disable the AMT function, do the following:

1. Select **MEBx Login**, and enter the default password “admin” in the password field.
2. Enter a new password. Password must comply with the following requirements concerning character types and length:
Must be between 8 and 32 characters long.
Must contain at least one number (“0”, “1-9”).
Must contain a mix of lower-case (“a”, “b”, “z”, etc.) and upper-case (“A”, “B”, “Z”, etc.) letter.
Must contain at least one special character of the following: ` ~ ! @ \$ % ^ & * () - = + [] ; ' < . > / ?
Underscore (“_”) is considered the same as Roman alphabet characters, and is not counted as a special character.



Key input is based on the US keyboard layout. The following table shows examples of the special characters in US keyboard layout.

Special character you want to input	Corresponding number key (SHIFT key + a number key)
!	1
@	2
#	3
\$	4
%	5
^	6
&	7
*	8
(9
)	0

3. Select **Intel(R) AMT Configuration**, and press the **Enter** key.
4. Select **Manageability Features Selection**, and press the **Enter** key.
5. Select **Disabled**, and press the **Enter** key.
6. Press the **Y** key, and press the **ESC** key.
7. Select **MEBx Exit**, and press **Y** key.
8. When the computer restarts, go to BIOS setup utility.
On the BIOS setup utility screen, change **AMT Setup Prompt to Disabled**.
9. Press the **F10** key to save the settings, and press the **Y** key.



- *When using the computer with the AC adaptor connected and the AMT function set to enabled, power might still be supplied to the system memory even when the computer power is turned off, or the computer is in Sleep Mode or Hibernation Mode.*
- *When connecting the AC adaptor, the computer is powered and can be turned on. If the power is automatically turned off after approximately 5 to 7 seconds, it is because the RTC lasting time runs out, and the settings of AMT function have been cleared. This is normal and not an error. If it occurs, the settings of AMT function must be reconfigured.*
- *If there is a problem when you start the computer, or initialize the Management Engine (ME) firmware after the RTC lasting time runs out, the system will automatically reset itself during setup. This is the function of AMT configurations and is not an error.*
- *Enabling the AMT function might cause the network LAN Enable/Disable items to be no longer changeable in BIOS setup utility. Consult with your system administrator about details.*
- *AMT function cannot be operated using a USB-LAN adaptor.*



The useable system memory for models equipped with the AMT function is 16 - 64 MB, less than that of models not equipped with the AMT function. The amount of the difference depends on the amount of memory installed.

Notes for system administrators

- Intel® AMT is enabled by default in the Management Engine (ME) firmware.
- Both the security of management console and the network management must be thoroughly implemented through management of AMT function. Otherwise administrator privileges might be abused by other parties which possibly lead to the leak of sensitive and/or proprietary information, data loss, HDD/SSD erasure, or file overwritten.
- When using the USB Provisioning function, you must turn on this function before using.
 1. Turn on the computer while pressing the **F2** key.
 2. On the BIOS setup utility screen, set the Supervisor Password on **Security** menu.
 3. Set **USB Provisioning of AMT** to **Enabled**.
 4. Press the **F10** key, and press **Y** key to save the setting.
- The following functions are not supported:
 - RPAT (Remote PC Assist Technology)
 - Remote BIOS update

Information about Intel® Authenticate

For Intel® Authenticate, please refer to
www.intel.com/authenticate
or related Intel website.

Legal Footnotes

Non-applicable Icons

Certain computer chassis are designed to accommodate all possible configurations for an entire product series. Therefore, be aware that your selected model might not have all the features and specifications corresponding to all of the icons or switches shown on the computer chassis.

CPU

Central Processing Unit (CPU) Performance Legal Footnotes.

CPU performance in your computer product might vary from specifications under the following conditions:

- use of certain external peripheral products
- use of battery power instead of AC power
- use of certain multimedia, computer generated graphics or video applications
- use of standard telephone lines or low speed network connections
- use of complex modeling software, such as high end computer aided design applications
- use of several applications or functionalities simultaneously
- use of computer in areas with low air pressure (high altitude >1,000 meters or >3,280 feet above sea level)
- use of computer at temperatures outside the range of 5°C to 30°C (41 -86°F) or >25°C (77°F) at high altitude (all temperature references are approximate and might vary depending on the specific computer model - contact TOSHIBA support for details).

CPU performance might also vary from specifications due to design configuration.

Under some conditions, your computer product might automatically shut down. This is a normal protective feature designed to reduce the risk of lost data or damage to the product when used outside recommended conditions. To avoid risk of lost data, always make back-up copies of data by periodically storing it on an external storage medium. For optimum performance, use your computer product only under recommended conditions. Read additional restrictions in your product documentation. Contact TOSHIBA technical service and support, refer to [TOSHIBA support](#) section for more information.

64-Bit Computing

Certain 32-bit device drivers and/or applications might not be compatible with a 64-bit CPU/operating system and therefore might not function properly.

Memory (Main System)

Part of the main system memory might be used by the graphics system for graphics performance and therefore reduce the amount of main system memory available for other computing activities. The amount of main system memory allocated to support graphics might vary depending on the graphics system, applications utilized, system memory size, and other factors.

If your computer is configured with more than 3 GB memory, the memory might be displayed as approximately 3 GB only (depending on the hardware specifications of the computer).

This is correct because the operating system usually displays the available memory instead of the physical memory (RAM) built into the computer.

Various system components (like the video adapter's GPU and PCI devices like Wireless LAN, and so on) require their own memory space. Since a 32-bit operating system cannot address more than 4 GB of memory, these system resources overlap the physical memory. It is a technical limitation that the overlapped memory is not available to the operating system. Even though some tools might display the actual physical memory built into your computer, the memory available to the operating system is still approximately 3 GB only.

Computers configured with a 64-bit operating system can address 4 GB or more of system memory.

Battery Life

Battery life might vary considerably depending on product model, configuration, applications, power management settings, and features utilized, as well as the natural performance variations produced by the design of individual components. Published battery life numbers are achieved on select models and configurations tested by TOSHIBA at the time of publication. Recharge time varies depending on usage. Battery might not charge while computer is consuming full power.

After going through many charge and discharge cycles, the battery loses its ability to perform at maximum capacity and needs to be replaced. This is a normal phenomenon for all batteries. To purchase a new battery pack, see the accessories information that is shipped with your computer.

Internal Storage Drive Capacity

1 Gigabyte (GB) means $10^9 = 1,000,000,000$ bytes using powers of 10. The computer operating system, however, reports storage capacity using

powers of 2 for the definition of 1 GB = 2^{30} = 1,073,741,824 bytes, and therefore shows less storage capacity. Available storage capacity will also be less if the product includes one or more pre-installed operating systems, such as Microsoft Operating System and/or pre-installed software applications, or media content. Actual formatted capacity might vary.

LCD

Over a period of time, and depending on the usage of the computer, the brightness of the LCD screen will deteriorate. This is an intrinsic characteristic of LCD technology.

Maximum brightness is only available when operating in AC power mode. Screen dims when the computer is operated on battery power and you might not be able to increase the brightness of the screen.

Wireless LAN

The transmission speed over the wireless LAN and the distance over which wireless LAN can reach might vary depending on surrounding electromagnetic environment, obstacles, access point design and configuration, and client design and software/hardware configurations.

The actual transmission speed is lower than the theoretical maximum speed.

Copy Protection

Applicable copy protection standards included in certain media might prevent or limit recording or viewing of the media.

Index

A

- AC adaptor
 - additional 4-40
 - connecting 2-2
 - DC IN 19V jack 3-6

B

- Battery
 - extending life 4-19
 - monitoring capacity 4-18
 - real time clock 3-13, 4-16
 - save mode 5-8
 - types 4-15

- Battery pack
 - replacing 4-19

- Bluetooth 7-7

C

- Cleaning the computer 1-19

- Cooling vents 3-5, 3-7

D

- DC IN/Battery indicator 3-13

- Display
 - automatic power off 5-8
 - opening 2-4
 - screen 3-11

- Documentation list 2-1

- Dual Pointing Device
 - AccuPoint 4-12

- Touch Pad 6-10

E

- Equipment checklist 2-1

- External monitor
 - problems 6-15

H

- Hard disk drive
 - automatic power off 5-8

K

- Keyboard
 - function keys 4-3
 - Function keys F1...F12 4-3
 - problems 6-7
 - Windows special keys 4-4

L

- LAN
 - cable types 4-29
 - connecting 4-29

M

- Media care
 - Card care 4-31
 - Memory card care 4-31

- Memory
 - installing 4-24
 - removing 4-27

memory media card
inserting 4-32
removing 4-33

Memory media slot 4-30

Moving the computer 1-20

MultiMediaCard
removing 4-33

Memory Media Card 6-9
Overheating power
down 6-5
Power 6-4
Real Time Clock 6-7
Sound system 6-14
TOSHIBA support 6-16
Touch Pad 6-10
USB device 6-12
USB mouse 6-11

O

Optical Disc Drive 4-5

P

Password
power on 5-8
Starting the computer by
password 5-6
Supervisor 5-6
user 5-5

Power
Hibernation Mode 2-11
panel on/off 5-9
Shut Down mode 2-8
Sleep Mode 2-9
turning off 2-8
turning on 2-5

Problems
AC power 6-5
Analyzing the problem 6-2
Battery 6-5
Dual Pointing device 6-10
External monitor 6-14
Hardware and system
checklist 6-4
HDD 6-8, 6-9
Internal display panel 6-8
Keyboard 6-7

R

Recovery hard disk drive 2-15
Recovery Media 2-14

S

SD/SDHC/SDXC Card
formatting 4-31
note 4-30

Security lock 4-39

SIM card
installing 4-21
removing 4-23

Sleep Mode
setting 2-9
System automatic 5-8

Smart Card
inserting 4-33
removing 4-34

Sound system
problems 6-14

U

USB device
problems 6-12

V

Video mode 4-42

W

Web Camera 3-10

Wireless communication 7-5