

Fellowes

Let your
productivity flow



SEASA™

Dual Stacking Monitor Arm

Dual Stacking Monitor Arm

Features:

- Opt for pure simplicity with our free standing monitor arm range
- Quickly adjusts to create a comfortable workspace to reduce your risk of eye, neck and back strain
- Independently tested to meet ergonomic requirements outlined in European Health and Safety Legislation: EN ISO 9241-5
- Increase your productivity with dual screen working - holds two screens up to 8kg and 32" each
- Made from 46% recycled materials and 99% recyclable



Specification:

Code	8044001
Colour	Black: RAL 9017
Product Dimensions (H x W x D)	902 x 389 x 279mm
Product Weight	4.43 kg
Outer Carton Dimensions (H x W x D)	79.4 x 300 x 448 mm
Outer Carton Weight	4.69 kg
Pole Height	905 mm
Height Adjustment Measurement	83 - 885 mm
Reach Range	-
Rotation	360°
Pan	+/-60° (120°)
Tilt	+/-45° (90°)
Arm Swivel	-
VESA	75 x 75 / 100 x 100
Weight Capacity (kg)	8kg per screen
Maximum Monitor Size	32" (81.28cm) diagonally / 590 mm (H)
Retail Barcode (UPC)	043859728060
Outer Carton Barcode (SCS)	50043859728065
Quantity per Outer Carton	1
Country of Origin	China
Warranty	5 years limited

Environmental:

Product	Product Material Breakdown		Product Recycled Content		
	Weight (g)	Weight (%)	Pre-Consumer Recycled Content (g)	Post Consumer Recycled Content (g)	Total Recycled Content (%)
Aluminium	16.70	0.4%	-	16.70	100%
Steel	3931.61	98.6%	-	1838.38	46.8%
Plastic	38.29	1.0%	-	-	-
Total	3986.60	100%	-	1855.08	46.5%

Packaging	Product Material Breakdown		Product Recycled Content		
	Weight (g)	Weight (%)	Pre-Consumer Recycled Content (g)	Post Consumer Recycled Content (g)	Total Recycled Content (%)
Paper / Card / Corrugated	692.68	98.0%	-	203.28	29.3%
LDPE (4) plastic bag	14.25	2.0%	-	-	-
Total	706.93	100%	-	203.28	28.8%

Pre-Consumer Recycled Content: Waste material that was created during the process of manufacturing or delivering goods prior to their delivery to consumers.

Post-Consumer Recycled Content: Waste material created by consumers. This material is diverted from landfills and utilized in the production of other commodities.

Recyclability:

Percentage of the product and packaging that can be easily separated for recycling.

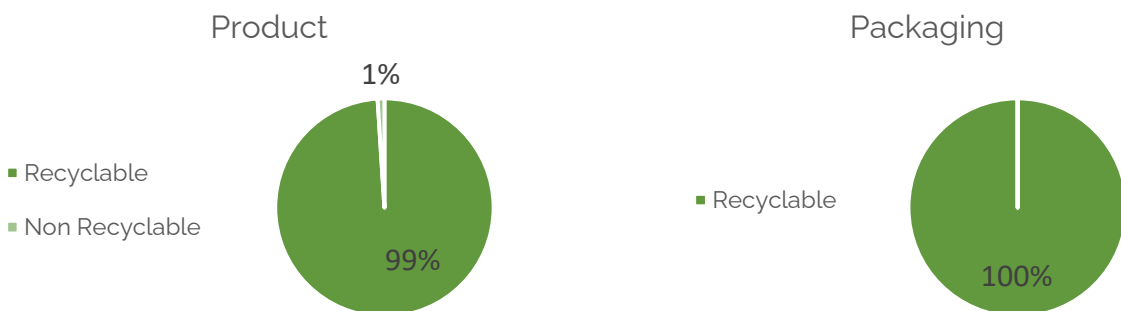

Ergonomic Working:



ZONE 3 RELIEVE NECK STRAIN

Achieve comfortable viewing.
Ensure your eyes are in line with
the top of your screen.

How to use a monitor arm

- 1. Arms Reach:** Whether sitting or standing check that your monitor is positioned so you can touch the screen with your fingertips and that you can easily read what is on your screen without straining.
- 2. Eye level:** Adjust the monitor arm until the top of your monitor/s are roughly level with your eyes.
- 3. Tilt:** Tilting the screen slightly upwards can help achieve a more neutral posture and reduce glare.
- 4. Multiple screens:** If you're using more than one monitor make sure:
 - The tops of each screen are level and positioned side by side;
 - You sit in the middle or in front of your main screen to reduce twisting and turning.

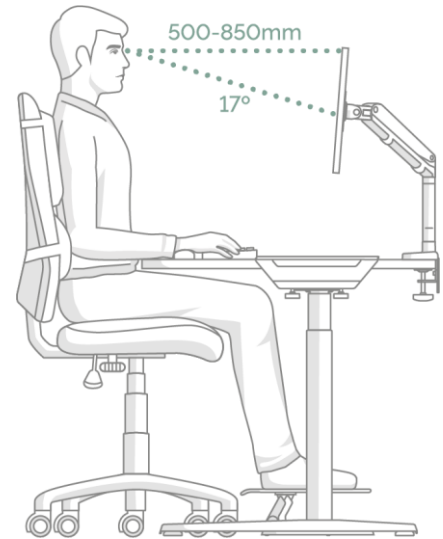

Certifications:

EN ISO 9241-5 1999 Ergonomic requirements for office work with visual display terminals (VDT's): part 5: 1999, workstation layout and postural requirements.

ANSI / BIFMA x5.5 – 2014 Desk/Table Products. Clause 22, 23, 24.



Aftercare:

Servicing: Check joint parts regularly to make sure the screws have not loosened.

Spare Parts: Available. Contact CS-UK@Fellowes.com or telephone 00800 18101810.

Cleaning: Wipe over with a damp microfibre cloth. Do not use any cleaning solutions.

Handling & Storage: Read and follow all instructions and warnings before use. This product is intended for indoor use only.

Dimensional Drawings:

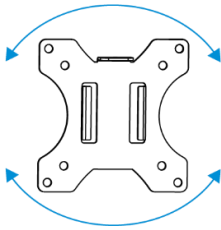
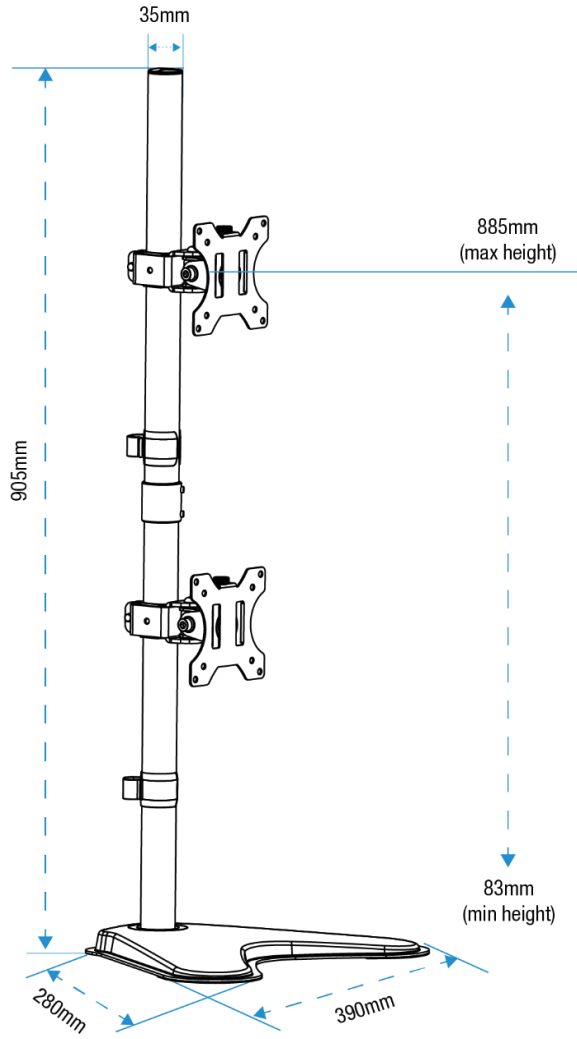

Rotation
 $\pm 360^\circ$

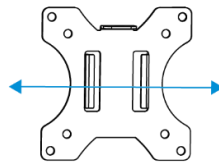

Pan
 120°

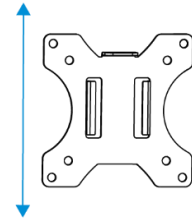

Tilt
 $\pm 45^\circ$

Every effort has been made to ensure that information provided in this document is up to date and accurate. However, Fellowes cannot guarantee and assumes no legal liability or responsibility for the accuracy or completeness of the information provide. In case of any query please contact us as www.Fellowes.com/locations.