

Fellowes

Let your
productivity flow



PLATINUM SERIES™
Dual Monitor Arm

PLATINUM SERIES™

Dual Monitor Arm

Features:

- Powerful flexibility with dual USB connectivity to keep devices within easy reach
- Gas spring adjustment for a comfortable workspace to reduce your risk of eye, neck and back strain
- Independently tested to meet ergonomic requirements outlined in European Health and Safety Legislation: EN ISO 9241-5
- Fly through tasks with dual screen working - holds two screens weighing 1.5 - 8kgs and up to 32" each
- Made from 57% recycled materials and 43% recyclable



Specification:

Code	8042501	8056301	8056501
Colour	Black: RAL 9017	White: RAL 9016	Silver: RAL 9006
Product Dimensions (H x W x D)	590 x 950 x 114 mm		
Product Weight	4.50 kg		
Retail Packaging Dimensions (H x W x D)	131 x 405 x 305 mm		
Retail Packaging Weight	5.64 kg		
Outer Carton Dimensions (H x W x D)	145 x 335 x 420 mm		
Outer Carton Weight	6.14 kg		
Dynamic Height Adjustability	280 mm		
Height Adjustment Range	135 - 415 mm		
Reach Range	63.5 - 505 mm		
Rotation	360°		
Pan	± 90° (180°)		
Tilt	± 45° (90°)		
Arm Swivel	360°		
Tension Adjustment	Yes		
USB Connectivity	2 x 3.0 USB Port 0.5A (Type A)		
VESA	75 x 75 / 100 x 100		
Clamp: Desk Thickness	10 - 85 mm		
Grommet: Desk Thickness	10 - 85 mm		
Grommet: Diameter	8.5 - 70 mm		
Weight Capacity (kg)	1.5 - 8 kg per arm		
Maximum Monitor Size	32" (81.28cm) diagonally / 830mm (H)		
Retail Barcode (UPC)	043859716968	043859764204	043859764228
Outer Carton Barcode (SCS)	50043859716963	50043859764209	50043859764223
Quantity per Outer Carton	1		
Country of Origin	China		
Warranty	5 years limited		

Environmental:

Product	Product Material Breakdown		Product Recycled Content		
	Weight (g)	Weight (%)	Pre-Consumer Recycled Content (g)	Post Consumer Recycled Content (g)	Total Recycled Content (%)
Aluminium	1567.49	34.9%	0	1567.49	100%
Steel	2254.39	50.1%	0	1020.17	45.3%
Plastic	106.18	2.4%	0	0	0
Electronics	208.44	4.6%	0	0	0
Other	360.0	8.0%	0	0	0
Total	4496.50	100%	0	2587.66	57.5%

Packaging	Product Material Breakdown		Product Recycled Content		
	Weight (g)	Weight (%)	Pre-Consumer Recycled Content (g)	Post Consumer Recycled Content (g)	Total Recycled Content (%)
Paper / Card / Corrugated	1102.16	96.7%	0	291.65	26.5%
LDPE (4) plastic bag	31.91	2.8%	0	0	0
Nylon plastic strap	6.00	0.5%	0	0	0
Total	1140.07	100%	0	291.65	25.6%

Pre-Consumer Recycled Content: Waste material that was created during the process of manufacturing or delivering goods prior to their delivery to consumers.

Post-Consumer Recycled Content: Waste material created by consumers. This material is diverted from landfills and utilized in the production of other commodities.

Recyclability:

Percentage of the product and packaging that can be easily separated for recycling.

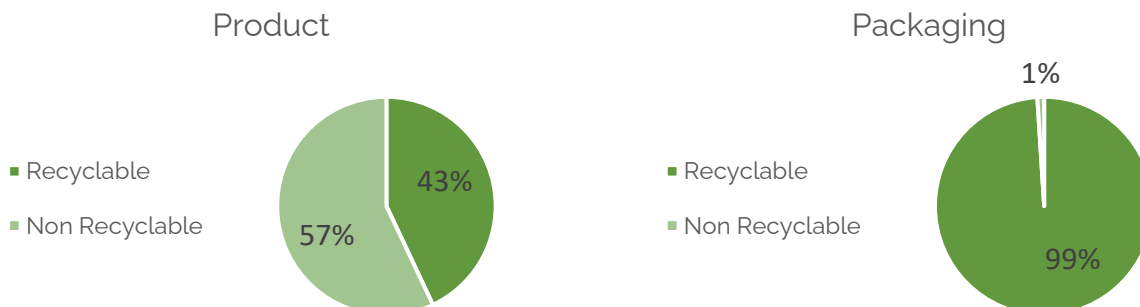

Ergonomic Working:



ZONE 3

RELIEVE NECK STRAIN

Achieve comfortable viewing.
Ensure your eyes are in line with
the top of your screen.

How to use a monitor arm

- 1. Arms Reach:** Whether sitting or standing check that your monitor is positioned so you can touch the screen with your fingertips and that you can easily read what is on your screen without straining.
- 2. Eye level:** Adjust the monitor arm until the top of your monitor/s are roughly level with your eyes.
- 3. Tilt:** Tilting the screen slightly upwards can help achieve a more neutral posture and reduce glare.
- 4. Multiple screens:** If you're using more than one monitor make sure:
 - The tops of each screen are level and positioned side by side;
 - You sit in the middle or in front of your main screen to reduce twisting and turning.

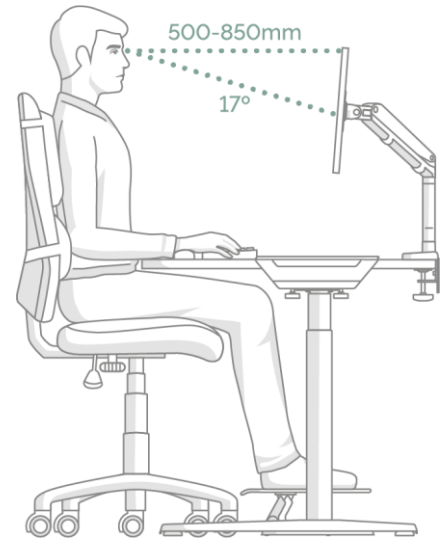

Certifications:

EN ISO 9241-5 1999 Ergonomic requirements for office work with visual display terminals (VDT's): part 5: 1999, workstation layout and postural requirements.

ANSI / BIFMA x5.5 – 2014 Desk/Table Products. Clause 22, 23, 24.



CAD Files:

.dwg CAD files available to download from pCon Catalog

OFML data available on all pCon platforms



Aftercare:

Servicing: Check joint parts regularly to make sure the screws have not loosened.

Spare Parts: Available. Contact CS-UK@Fellowes.com or telephone 00800 18101810.

Cleaning: Wipe over with a damp microfibre cloth. Do not use any cleaning solutions.

Handling & Storage: Read and follow all instructions and warnings before use. This product is intended for indoor use only.

Dimensional Drawings:

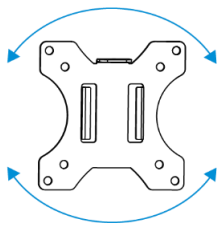
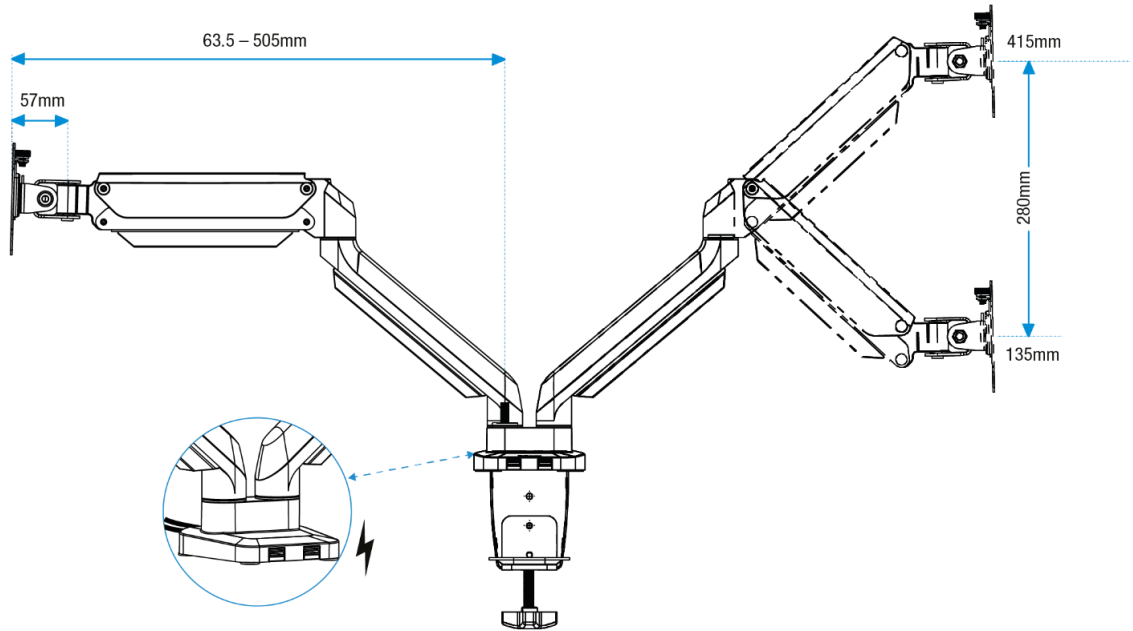
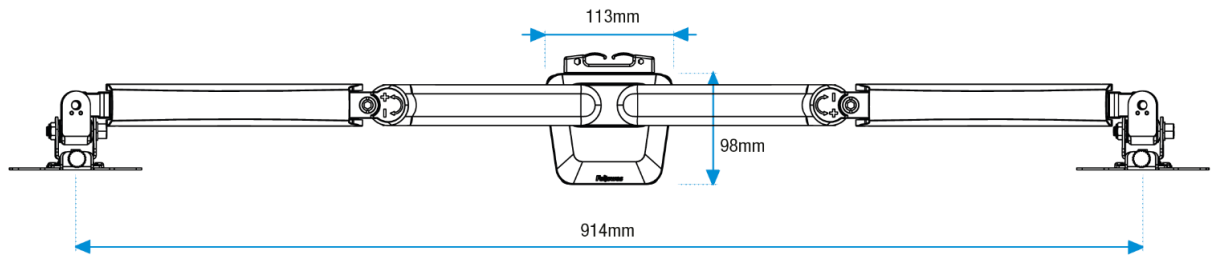

Rotation
±360°

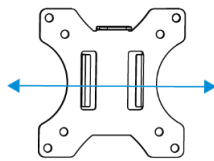

Pan
180°

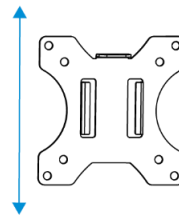

Tilt
±45°

